

PEUGEOT



HANDBOOK

2008



Download on the
App Store

GET IT ON
Google Play

Access to the Handbook



MOBILE APPLICATIONS

Install the **MYPEUGEOT APP** application (content available offline).

Also available in the **Scan MyPeugeot App** application.



TOUCH SCREEN (depending on availability)



In the **Help** touch screen application, select the **User Manual** tab.

Several types of searches are available to access the information sought.

For safety reasons, this application is not accessible while driving above 3 mph (5 km/h).



ONLINE

View or download the handbook at the following address:

<http://public.servicebox.peugeot.com/APddb/>



Scan this QR Code for direct access.

Select:

- the language,
- the vehicle and body style,
- the issue period of the handbook corresponding to the date of 1st registration of the vehicle.



This symbol indicates the latest information available.

Welcome

Thank you for choosing a Peugeot 2008 or a Peugeot e-2008.

This document contains the key information and recommendations you will need to be able to explore your vehicle in complete safety. We strongly recommend familiarising yourself with it, as well as the Maintenance and Warranty Guide.

Your vehicle will be fitted with only some of the equipment described in this document, depending on its trim level, version and the specification for the country in which it was sold.

The descriptions and illustrations are for guidance only.

Automobiles PEUGEOT reserves the right to modify the technical specifications, equipment and accessories without having to update this document.

If ownership of your vehicle is transferred, please ensure this **Handbook** is passed on to the new owner.

 For any work on your vehicle, contact a qualified workshop that has the required technical information, skills and equipment, all of which a PEUGEOT dealer is able to provide.

Key



Safety warning



Additional information



Environmental protection feature



Left-hand drive vehicle



Right-hand drive vehicle



Location of equipment/button indicated using a black area



Active Safety Brake with Collision Risk Alert and Intelligent emergency braking assistance	131
Distraction detection	134
Parking sensors	136
Visiopark 1 - Visiopark 2	138

7 Practical information

Compatibility of fuels	144
Refuelling	144
Misfuel prevention (Diesel)	145
Electrified vehicles - General recommendations	145
Charging system (Electric)	146
Charging the traction battery (Electric)	154
Towing device	158
Towing device with quickly detachable towball	159
Roof bars	161
Snow chains	162
Very cold climate screen	162
Energy economy mode	163
Bonnet	164
Engine compartment	165
Checking levels	166
Checks	168
AdBlue® (BlueHDi)	170
Free-wheeling	172
Advice on care and maintenance	173

8 In the event of a breakdown

Warning triangle	176
Running out of fuel (Diesel)	176
Tool kit	176
Temporary puncture repair kit	178
Spare wheel	180
Changing a bulb	183

Fuses	185
12 V battery / Accessory battery	185
Towing the vehicle	189

9 Technical data

Engine technical data and towed loads	192
Petrol engines	193
Diesel engines	194
Electric engines	195
Dimensions	196
Identification markings	196

10 Touch screen 10" & Bluetooth Radio & Telephone

First steps	197
Steering mounted controls	198
Menus	198
Radio	199
DAB (Digital Audio Broadcasting) radio	201
Media	201
Telephone	202
Applications	206
Settings	207
Frequently asked questions	208

11 PEUGEOT i-Connect Advanced - PEUGEOT i-Connect

First steps	211
Customisation	214
Steering mounted controls	215
Applications	215
Voice commands	216
Navigation	217

Connectivity	218
Mirror Screen	220
Media	221
Phone	223
Settings	224
Help	225

12 Vehicle data recording and privacy

Alphabetical index

Appendix

Instruments and controls

These illustrations and descriptions are intended as a guide. The presence and location of certain elements may vary, depending on the version or trim level.

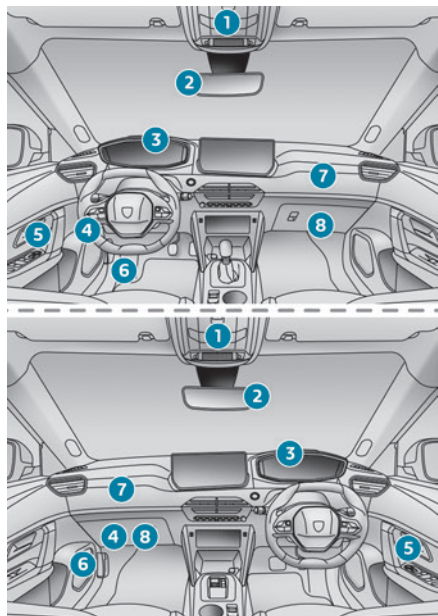

1. Courtesy lamp/Front reading lamps
Emergency and assistance call buttons
Sunroof
Warning lamps display for seat belts and front passenger airbag
2. Interior rear view mirror
3. Instrument panel
4. Fusebox
5. Electric windows
Electric door mirrors
6. Bonnet release
7. Front passenger airbag
8. Glove box

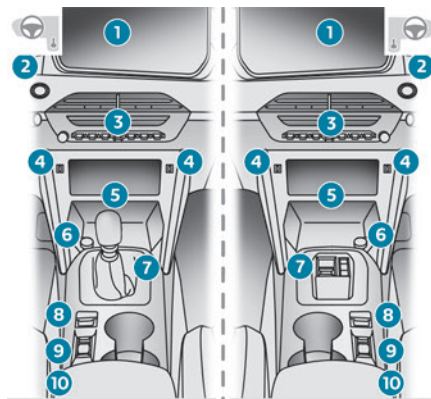

1. Touch screen
2. Switching the engine on/off
3. Central controls

4. USB socket(s)
5. Storage compartment or Wireless smartphone charger
6. Storage compartment/12 V socket
7. Gearbox or drive selector
8. Electric parking brake
9. Choice of driving mode
Advanced Grip Control
10. Hill Assist Descent Control

Steering-mounted controls

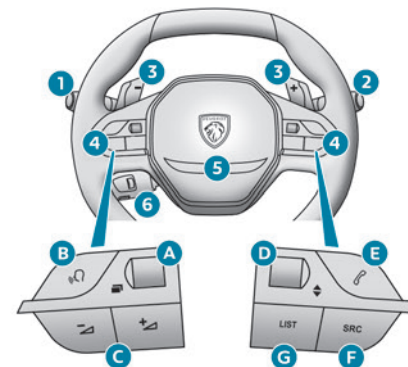

1. Exterior lighting controls/Direction indicators/
Service indicator
2. Wiper/Screenwash/Trip computer controls
3. Automatic gearbox control paddles
4. Audio system controls
- A. Select the instrument panel display mode

- B. Voice commands
- C. Decrease/Increase volume
- D. Select previous/next media
Confirm a selection
- E. Access the **Telephone** menu
Manage calls
- F. Select an audio source
- G. Display the list of radio stations/audio tracks
- 5. Horn/Driver front airbag
- 6. Controls for Cruise control/Speed limiter/
Adaptive cruise control

Side controls

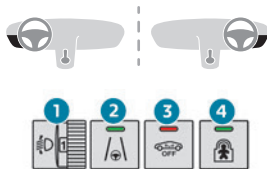

- 1. LED technology headlamps beam height adjustment
- 2. Lane positioning assist
- 3. Alarm
- 4. Electric child lock

Central controls

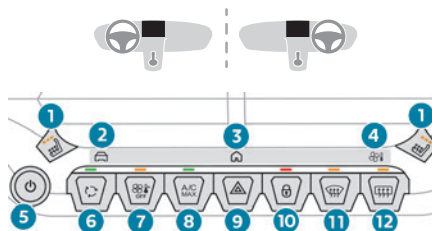

- 1. Heated seats
- 2. With Touch screen 10" & Bluetooth Radio & Telephone:
Direct access to the **Driving** menu
With PEUGEOT i-Connect Advanced -
PEUGEOT i-Connect:
Access to the Shortcuts for driving aids
- 3. With Touch screen 10" & Bluetooth Radio & Telephone:
Access to the touch screen menus
With PEUGEOT i-Connect Advanced -
PEUGEOT i-Connect:
Access to the HOME pages
- 4. With Touch screen 10" & Bluetooth Radio & Telephone:
Direct access to the **Climate** menu
With PEUGEOT i-Connect Advanced -
PEUGEOT i-Connect:
Direct access to the **Climate** application
- 5. Touch screen on/off/Adjust volume
- 6. Interior air recirculation

- 7. Thermal comfort system switch-off
- 8. Maximum air conditioning
- 9. Hazard warning lamps
- 10. Central locking
- 11. Front demisting/de-icing
- 12. Rear screen de-icing

Electric motor

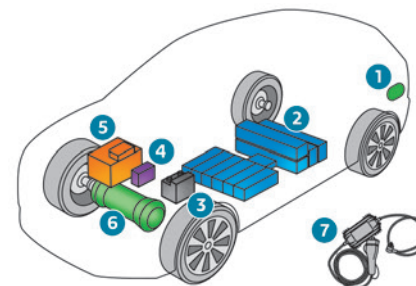

- 1. Charging connectors
- 2. Traction battery
- 3. Accessory battery
- 4. Heat pump
- 5. On-board charger
- 6. Electric motor
- 7. Charging cable

The charging connectors 1 enable 3 types of charging:

- Domestic charging in mode 2 using a domestic socket and associated charging cable 7.

- Accelerated charging in mode 3 using an accelerated charging unit (Wallbox).

- Superfast charging in mode 4 using a fast public charger.

The 400 V traction battery **2** uses Lithium-Ion technology. It stores and supplies the energy required for the operation of the electric motor, air conditioning and heating. Its charge level is represented by an indicator and a reserve power warning lamp on the instrument panel.

The 12 V accessory battery **3** powers the vehicle's conventional electrical system. It is recharged automatically by the traction battery via the on-board charger.

The heat pump **4** provides passenger compartment heating and regulates traction battery and on-board charger cooling.

The on-board charger **5** manages the domestic charging (mode 2) and accelerated charging (mode 3) of the traction battery as well as the recharging of the 12 V accessory battery.

The electric motor **6** provides propulsion in accordance with the selected driving mode and driving conditions. It recovers energy during vehicle braking and deceleration phases.

Labels

"Ease of use and comfort - Rear bench seat - Rear head restraints" section:



"Ease of use and comfort - Front fittings - Wireless smartphone charger" section:



"Lighting and visibility - Exterior lighting control stalk" and **"In the event of a breakdown - Changing a bulb"** sections:



"Safety - General safety recommendations - Installing electrical accessories" section:



"Safety - Child seats - Deactivating the front passenger airbag" section:



"Safety - ISOFIX mountings" section:



"Driving - Electric parking brake" section:



"Driving - Stop & Start" section:



"Practical information - Compatibility of fuels" section:



"Practical information - Charging system (Electric)" section:



"Practical information - Charging the traction battery (Electric)" section:



"Practical information - Bonnet" section:



"Practical information - Checking levels - Engine coolant" section:



"In the event of a breakdown - Temporary puncture repair kit" section:

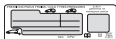

"In the event of a breakdown - Spare wheel" section:



"In the event of a breakdown - 12 V battery/ Accessory battery" section:



Eco-driving

Eco-driving refers to a range of everyday practices that allow the motorist to optimise the vehicle's energy consumption (fuel and/or electricity) and CO₂ emissions.

Optimise your use of the gearbox

With a manual gearbox, move off gently and change up promptly. While accelerating, change up early.

With an automatic gearbox, favour automatic mode. Do not depress the accelerator pedal heavily or suddenly.

The gear shift indicator prompts you to engage the most suitable gear. Whenever this indication is displayed on the instrument panel, follow it straight away.

With an automatic gearbox, this indicator appears only in manual mode.

Drive smoothly

Maintain a safe distance between vehicles, use engine braking rather than the brake pedal and press the accelerator gradually. These practices help to save on energy consumption, reduce CO₂ emissions and decrease general traffic noise.

Favour the use of the "Eco" driving mode by selecting it using the "DRIVE MODE" control.

With an EAT8 gearbox, with the gear selector in mode **D**, and except in Sport mode, favour "free-wheeling" by gradually lifting your foot fully off the accelerator pedal in order to save fuel.

When the traffic is flowing smoothly, select the cruise control.

Control the use of electrical equipment

Before moving off, if the passenger compartment is too warm, ventilate it by opening the windows and air vents before using the air conditioning. At speeds above 31 mph (50 km/h), close the windows and leave the air vents open.

Consider using equipment that can help keep the temperature in the passenger compartment down (e.g. sunroof blind, window blinds). Unless automatically regulated, switch off the air conditioning as soon as the desired temperature has been reached.

Switch off the demisting and defrosting functions, if they are not managed automatically.

Switch off the heated seat as soon as possible.

Adapt your use of the headlamps and/or foglamps to the level of visibility, in accordance with current legislation in the country in which you are driving.

Avoid running the engine before moving off, particularly in winter (other than in severe wintry conditions: temperature below -23°C). The vehicle will warm up much faster while driving.

As a passenger, avoid connecting your multimedia devices (e.g. film, music, video game) to help reduce the consumption of energy. Disconnect all portable devices before leaving the vehicle.

Limit the causes of excess consumption

Spread loads throughout the vehicle. Place the heaviest items in the boot as close as possible to the rear seats.

Limit the loads carried in the vehicle and minimise wind resistance (e.g. roof bars, roof rack, bicycle carrier, trailer). Preferably, use a roof box.

Remove roof bars and roof racks after use.

At the end of winter, remove snow tyres and refit summer tyres.

Avoid using Sport mode for too long, in order to limit your energy consumption.

Comply with the servicing instructions

Check tyre pressures regularly, with the tyres cold, referring to the label in the door aperture on the driver's side.

Carry out this check in particular:

- before a long journey.
- at each change of season.
- after a long period out of use.

Do not forget the spare wheel and, where applicable, the tyres on your trailer or caravan.

Have your vehicle serviced regularly (e.g. engine oil, oil filter, air filter, passenger compartment filter, etc.). Observe the schedule of operations in the manufacturer's service schedule.

With a BlueHDi Diesel engine, if the SCR system has a fault, your vehicle will emit pollution. Visit a PEUGEOT dealer or a qualified workshop as soon as possible to restore your vehicle's nitrogen oxide emissions to legal levels.

When filling the fuel tank, do not continue after the third cut-out of the nozzle, to avoid overflow. You will only see the fuel consumption of your new vehicle settle down to a consistent average after the first 1,900 miles (3,000 kilometres).

Optimising the driving range (Electric)

The vehicle's consumption of electrical energy greatly depends on the route, speed and driving style, as well as the use of the heating/air conditioning.

Try to remain in the "**ECO**" zone on the power indicator, by driving smoothly and maintaining a steady speed.

Program a destination into the vehicle's GPS navigation system to optimise consumption during a journey.

Anticipate the need to slow down, and brake smoothly, whenever possible using engine braking with the regenerative braking function, which will move the power indicator into the "**CHARGE**" zone.

Use the air conditioning rather than the heating to demist the passenger compartment.

Matrix instrument panel

Dials



Petrol / Diesel



Electric

1. Coolant temperature indicator (°C) (Petrol or Diesel)
Thermal comfort consumption indicator (Electric)
2. Analogue speedometer (mph or km/h)
3. Matrix display
4. Rev counter (x 1,000 rpm), graduation depends on the engine (Petrol or Diesel)
Power indicator (Electric)
5. Fuel gauge (Petrol or Diesel)
Charge level indicator (Electric)

Matrix display

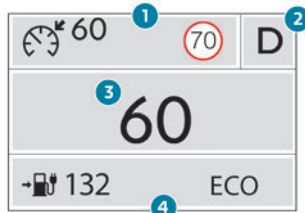
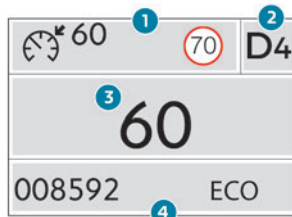

The matrix display can be personalised using a system of pages.

1. Cruise control / speed limiter settings
Display of speed limit signs
2. Gear shift indicator (arrow and recommended gear)
Selector position and gear on automatic gearbox (Petrol or Diesel)
Drive selector position (Electric)

3. Personalisable area:
 - Digital speedometer (mph or km/h)
 - Display of driving aids
 - Trip computer information
 - Power flow / vehicle charge state (Electric)
4. Service indicator, then total distance recorder (miles or km)
Remaining range (Electric)
These functions are displayed in turn when the ignition is switched on.
Driving mode selected (other than "Normal" mode)

Choosing the displayed page

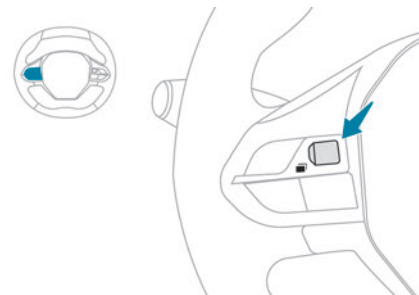

- ▶ Turn the thumbwheel on the left of the steering wheel to display and scroll through the various pages.
- ▶ Press the thumbwheel to confirm.

If you do not press the thumbwheel, the selected page is automatically applied after a few moments.

Digital instrument panels

With PEUGEOT i-Connect Advanced - PEUGEOT i-Connect

This head-up 2D or 3D digital instrument panel can be personalised. Depending on the display mode selected, some information is hidden or presented differently. Example with the "Dials" display mode:



Petrol / Diesel

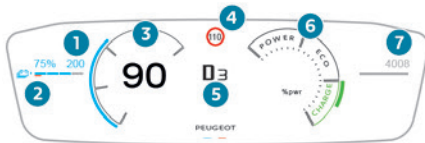

Electric

1. Remaining range (miles or km)
2. Fuel gauge (Petrol or Diesel)
Charge level indicator (Electric)
3. Digital speedometer (mph or km/h)

4. Cruise control/speed limiter settings
Display of speed limit signs
5. Gear shift indicator (arrow and recommended gear)
Selector position and gear on automatic gearbox (Petrol or Diesel)
Drive selector position (Electric)
Driving mode selected (other than "Normal" mode)
6. Rev counter (x 1,000 rpm) (Petrol or Diesel)
Power indicator (Electric)
7. Total distance recorder (miles or km)
8. Coolant temperature indicator (°C) (Petrol or Diesel)

The default pages are as follows:

- Dials.
- Minimal.
- Energy flows (Electric).
- Driving aids.
- Navigation (depending on equipment).
- Personal 1.
- Personal 2.

Information displayed on the instrument panel

The information displayed on the instrument panel (e.g. warning lamps, indicators) may have a fixed or variable location depending on the page or the driving aid activated.

For the functions that have indicator lamps for both operation and deactivation, there is only one dedicated location.

Display language and units

These depend on the touch screen settings.

When travelling abroad, the speed must be shown in the official units of the country you are driving in (mph, miles or km/h, km).

Choice of the displayed page

By default, pages are memorised in the instrument panel.

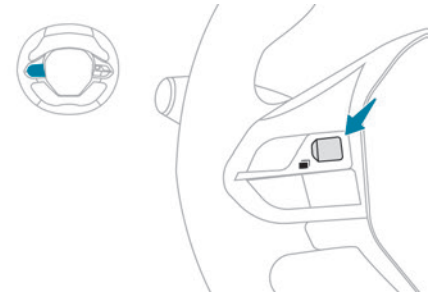

- ▶ Turn the thumbwheel on the left of the steering wheel to display and scroll through the various pages on the instrument panel.
- ▶ Press the thumbwheel to confirm the page. The new page is applied immediately. If there is no action on the thumbwheel, the selected display page is applied automatically after a few moments.

When a message is displayed in a temporary window, pressing this

thumbwheel will cause this window to disappear immediately.

Settings for displayed pages

The available settings operations are: addition, deletion and layout of pages.

It is possible to memorise up to 5 pages.

The colour can also be configured according to the selected driving mode.



The settings are changed via the **Settings > Customization** touch screen application.

Settings for a "Personal" display page

In the two additional personal pages, the types of information available are as follows:

- Dynamic (Torque, Boost, Power).
- G-metres.
- Engine temperatures (Petrol or Diesel).
- Rev counter (Petrol or Diesel).
- Energy flows (Electric).
- Power indicator (Electric).
- Accessories consumption (Electric).
- Media.
- Trip computer.
- Driving aids.
- Navigation.

i The type of information selected in the "Personal 1" page is not available in the "Personal 2" page.



The settings are changed via the **Settings > Customization** touch screen application.

For more information on **Personalisation - Instrument Panel**, refer to the corresponding section for the Audio equipment and telematics systems.

Warning and indicator lamps

Displayed as symbols, the warning and indicator lamps inform the driver of the occurrence of a malfunction (warning lamps) or of the operating status of a system (operation or deactivation indicator lamps). Certain lamps light up in two ways (fixed or flashing) and/or in several colours.

Associated warnings

The illumination of a lamp may be accompanied by an audible signal and/or a message displayed in a screen.

Relating the type of alert to the operating status of the vehicle allows you to determine whether the situation is normal or whether a fault has occurred: refer to the description of each lamp for further information.

When the ignition is switched on

Certain red or orange warning lamps come on for a few seconds when the ignition is switched on. These warning lamps should go off as soon as the engine is started.

For more information on a system or a function, refer to the corresponding section.

Persistent warning lamp

If a red or orange warning lamp comes on, there may be a fault which needs further investigation.

If a lamp remains lit

The references (1), (2) and (3) in the warning and indicator lamp description indicate whether you should contact a qualified professional in addition to the immediate recommended actions.

(1): You must stop the vehicle.

Stop as soon as it is safe to do so and switch off the ignition.

(2): Contact a PEUGEOT dealer or a qualified workshop.

(3): Go to a PEUGEOT dealer or a qualified workshop.

List of warning and indicator lamps

Red warning/indicator lamps

STOP



Fixed, associated with another warning lamp, accompanied by the display of a message and an audible signal.

A serious fault with the engine, braking system, power steering or automatic gearbox or a major electrical fault has been detected.

Carry out (1) and then (2).

Engine self-diagnostics system (Petrol or Diesel)



Fixed.

A major engine fault has been detected.

Carry out (1) and then (2).

Maximum coolant temperature (Petrol or Diesel)



Fixed with display blocks lit in red (with matrix instrument panel).

or

Fixed (except on matrix instrument panel).

The temperature of the cooling system is too high.

Carry out (1), then wait until the engine has cooled down before topping up the level, if necessary. If the problem persists, carry out (2).

Engine oil pressure (Petrol or Diesel)



Fixed.

There is a fault with the engine lubrication system.

Carry out (1) and then (2).

System malfunction (Electric)



Fixed.

A fault involving the electric motor or traction battery has been detected.

Carry out (1) and then (2).

Cable connected (Electric)



Fixed when the ignition is switched on.

The charging cable is connected to the vehicle's connector.



Fixed when the ignition is switched on, accompanied by a message.

It is not possible to start the vehicle while the charging cable is connected to the vehicle's connector.

Disconnect the charging cable and close the flap.

Traction battery overheating (Electric)



Fixed, combined with the STOP warning lamp, accompanied by the display of a message and an audible signal.

The traction battery's temperature is too high.

Carry out (1).

Evacuate the vehicle as quickly as possible and move to a safe distance.

Carry out (2).

Traction battery malfunction (Electric)



Fixed, combined with the Service warning lamp, accompanied by the display of a message.

The traction battery has a fault.

Carry out (2).

12 V battery charge



Fixed.

The battery charging circuit is faulty (e.g. dirty terminals, loose or severed alternator belt).

Carry out (1).

If the electric parking brake stops working, immobilise the vehicle:

- ▶ With the manual gearbox, engage a gear.

▶ With the EAT6 automatic gearbox, move the gear selector to position P.

▶ With the EAT8 automatic gearbox or drive selector, fit the chock against one of the wheels. Clean and tighten the terminals. If the warning lamp does not go off when the engine is started, carry out (2).

Door(s) open



Fixed, associated with a message identifying the access.

A door or the tailgate is not properly closed (speed less than 6 mph (10 km/h)).



Fixed, associated with a message identifying the access, accompanied by an audible signal.

A door or the tailgate is not properly closed (speed above 6 mph (10 km/h)).

Seat belts not fastened/unfastened



Fixed or flashing, accompanied by an increasing audible signal.

A seat belt has not been fastened or has been unfastened.

Manual parking brake



Fixed.

The parking brake is applied or not properly released.

Electric parking brake



Fixed.

The electric parking brake is applied.



Flashing.

Application/release is faulty.

Carry out (1): park on flat ground (on a level surface).

With a manual gearbox, engage a gear.

With an automatic gearbox or drive selector, select mode **P**.

Switch off the ignition and carry out (2).

Braking



Fixed.

The brake fluid level in the braking circuit has dropped significantly.

Carry out (1), then top up with fluid that complies with the manufacturer's recommendations. If the problem persists, carry out (2).



Fixed.



The electronic brake force distribution (EBFD) system is faulty.

Carry out (1) and then (2).

Orange warning/indicator lamps

Service



Temporarily on, accompanied by the display of a message.

One or more minor faults, for which there is/are no specific warning lamp(s), have been detected. Identify the cause of the fault using the message displayed on the instrument panel.

You may be able to deal with some faults yourself, such as changing the battery in the remote control.

For other faults, such as with the tyre under-inflation detection system, carry out (3).



Fixed, accompanied by the display of a message.

One or more major faults, for which there is/are no specific warning lamp(s), have been detected. Identify the cause of the fault using the message displayed on the instrument panel, then carry out (3).



Fixed, accompanied by the message "**Parking brake fault**".

Automatic release of the electric parking brake is unavailable.

Carry out (2).



Service warning lamp fixed and service spanner flashing then fixed.

The servicing interval has been exceeded. The vehicle must be serviced as soon as possible.

Only with BlueHDi Diesel engines.

Engine preheating (Diesel)



Temporarily on (up to approximately 30 seconds in severe weather conditions).

When switching on the ignition, if the weather conditions and the engine temperature make it necessary.

Wait until the warning lamp goes off before starting.

When the warning lamp goes off, starting will occur immediately if you press and hold:

- the clutch pedal with a manual gearbox.
- the brake pedal with an automatic gearbox.

If the engine does not start, make the engine starting request again, while keeping your foot on the pedal.

Particle filter (Diesel)



Fixed, accompanied by an audible signal and a message about the risk of particle filter blockage.

The particle filter is nearing saturation.

As soon as traffic conditions allow, regenerate the filter by driving at a speed of at least 37 mph (60 km/h), with an engine speed of above 2,500 rpm, until the warning lamp goes off.



Fixed, accompanied by an audible signal and a message indicating that the additive level in the particle filter is too low.

The low level in the additive tank has been reached.

Top up without delay: carry out (3).

Low fuel level (Petrol or Diesel)



Fixed, with the blocks lit red, accompanied by an audible signal (with the matrix instrument panel)

or

Fixed, with the reserve level shown in red, accompanied by an audible signal and the display of a message (except with the matrix instrument panel).

When it first comes on, there are **approximately 5 litres of fuel** remaining in the tank (reserve).

Until the fuel level is topped up, this alert will be repeated every time the ignition is switched

on, with increasing frequency as the fuel level decreases and approaches zero.
 Refuel without delay to avoid running out of fuel.
Never drive until completely empty, as this could damage the emissions control and injection systems.

Low traction battery level (Electric)



Fixed, accompanied by an audible signal.
 The state of charge of the traction battery is low.

View the remaining range.

Put the vehicle on charge as soon as possible.

Tortoise mode with limited driving range (Electric)



Fixed.
 The state of charge of the traction battery is critical.

The engine power gradually decreases.

You must put the vehicle on charge.

If the warning lamp remains lit, carry out (2).

Engine self-diagnostic system (Petrol or Diesel)



Flashing.
 The engine management system has a fault.

There is a risk that the catalytic converter will be destroyed.

You **must** carry out (2).



Fixed.
 The emissions control system has a fault.
 The warning lamp should go off when the engine is started.

Carry out (3) without delay.

Engine self-diagnostics system (Petrol or Diesel)



Fixed.
 A minor engine fault has been detected.

Carry out (3).

AdBlue® (BlueHDi)



On for around 30 seconds when starting the vehicle, accompanied by a message indicating the driving range.

The driving range is between 1,500 and 500 miles (2,400 and 800 km).

Top up the AdBlue®.



Fixed, on switching on the ignition, accompanied by an audible signal and a message indicating the driving range.

The driving range is between 500 and 62 miles (800 and 100 km).

Promptly top up the AdBlue®, or carry out (3).



Flashing, accompanied by an audible signal and a message indicating the driving range.

The driving range is less than 62 miles (100 km).

You **must** top up the AdBlue® to **avoid engine starting being prevented**, or carry out (3).



Flashing, accompanied by an audible signal and a message indicating that starting is prevented.

The AdBlue® tank is empty: the legally required engine immobiliser system prevents the engine from starting.

To restart the engine, top up the AdBlue® or carry out (2).

It is **essential** to add at least 10 litres of AdBlue® to the tank.

SCR emissions control system (BlueHDi)



Fixed when the ignition is switched on, accompanied by an audible signal and a message.

A malfunction of the SCR emissions control system has been detected.

This alert disappears once the exhaust emissions return to normal levels.



Flashing AdBlue® warning lamp on switching on the ignition, with the Engine self-diagnostics warning lamp on fixed, accompanied by an audible signal and a message indicating the driving range.

Depending on the message displayed, it is possible to drive for up to 685 miles (1,100 km) before the engine immobiliser is triggered.

Carry out (3) without delay, to **avoid starting being prevented**.



Flashing AdBlue® warning lamp on switching on the ignition, with the Engine self-diagnostics warning lamp on fixed, accompanied by an audible signal and a message indicating that starting is prevented.

The engine immobiliser prevents the engine from restarting (the permitted driving limit has been exceeded after confirmation of a malfunction of the emissions control system).

To start the engine, carry out (2).

Automatic functions deactivated (electric parking brake)



Fixed.

The "automatic application" (on switching off the engine) and "automatic release" (on acceleration) functions are deactivated.

If automatic application/release is no longer possible:

- ▶ Start the engine.
- ▶ Use the control to apply the electric parking brake.
- ▶ Take your foot fully off the brake pedal.
- ▶ Hold the control pressed in the release direction for between 10 and 15 seconds.
- ▶ Release the control.
- ▶ Depress and hold the brake pedal.
- ▶ Pull the control in the application direction for 2 seconds.
- ▶ Release the control and the brake pedal.

Malfunction (with electric parking brake)



Fixed, accompanied by the message "Parking brake fault".

The vehicle cannot be immobilised with the engine running.

If manual application and release commands are not working, the electric parking brake control is faulty.

The automatic functions must be used at all times and are automatically reactivated in the event of a fault with the control.

Carry out (2).



Fixed, accompanied by the message "Parking brake fault".

The electric parking brake is faulty: manual and automatic functions may not be working.

When stationary, to immobilise the vehicle:

- ▶ Pull the electric parking brake control and hold it for approximately 7 to 15 seconds, until the indicator lamp lights up on the instrument panel.

If this procedure does not work, secure the vehicle:

- ▶ Park on a level surface.
- ▶ With a manual gearbox, engage a gear.
- ▶ With an automatic gearbox or drive selector, select mode **P**, then place the supplied chock against one of the wheels.

Then carry out (2).

Collision Risk Alert/Active Safety Brake



Fixed, accompanied by the display of a message.

The system has been deactivated via the touch screen.



Flashing.

The system activates and brakes the vehicle momentarily to reduce the speed of collision with the vehicle in front.

For more information, refer to the **Driving** section.



Fixed, accompanied by a message and an audible signal.

The system has a fault.

Carry out (3).



Fixed.

The system has a fault.

If these warning lamps come on after the engine is switched off and then restarted, carry out (3).

Anti-lock braking system (ABS)



Fixed.

The anti-lock braking system has a fault.

The vehicle retains conventional braking.

Drive carefully at moderate speed, then carry out (3).

Power steering



Fixed.

The power steering has a fault.

Drive carefully at moderate speed, then carry out (3).

Dynamic stability control (DSC)/Anti-slip regulation (ASR)



Fixed.

The system is deactivated.

The DSC/ASR system is reactivated automatically when the vehicle is restarted, and at speeds above approximately 31 mph (50 km/h).

At speeds below 31 mph (50 km/h), it can be reactivated manually.



Flashing.

DSC/ASR system regulation is activated in the event of a loss of grip or trajectory.



Fixed.

The DSC/ASR system has a fault.

Carry out (3).

Emergency brake malfunction (with electric parking brake)



Fixed, accompanied by the message "**Parking brake fault**".

Emergency braking does not deliver optimal performance.

If automatic release is not available, use manual release or carry out (3).

Hill start assist



Fixed, accompanied by the message "**Anti roll-back system fault**".

The system has a fault.

Carry out (3).

Road signs recognition



Fixed, accompanied by the display of a message and an audible signal.

The system has a fault.

Carry out (3).



Fixed, accompanied by the display of the message "**Driving Assistance Sensor blind: Clean sensor, see User Manual**".

The sensor is masked.

Stop as soon as it is safe to do so and switch off the ignition.

Clean the front camera.

Lane keeping assist



Flashing.

You are about to cross a broken lane marking without operating the direction indicators.

The system is activated, then corrects the trajectory if it detects a risk of unintentionally crossing a line or hard shoulder (depending on version).

For more information, refer to the **Driving** section.



Fixed.

The system has been automatically deactivated or placed on standby.



Fixed, accompanied by the display of the message "**Driving Assistance Sensor blind: Clean sensor, see User Manual**".

The sensor is masked.

Stop as soon as it is safe to do so and switch off the ignition.

Clean the front camera.



Fixed.

The system has a fault.

Carry out (3).

Driver Attention Warning by Camera (Distraction detection)



Fixed.

The system is deactivated.



Fixed, accompanied by the display of a message and an audible signal.

The system has a fault.

Carry out (3).



Fixed, accompanied by the display of the message "**Driving Assistance Sensor blind: Clean sensor, see User Manual**".

The sensor is masked.

Stop as soon as it is safe to do so and switch off the ignition.

Clean the front camera.

Lane positioning assist



Fixed, accompanied by the Service warning lamp.

The system has a fault.

Carry out (3).

Airbags



Fixed.

One of the airbags or seat belt pyrotechnic pretensioners is faulty.

Carry out (3).

Front passenger airbag (ON)



Fixed.

The front passenger airbag is activated.

The control is set to the "**ON**" position.

In this case, do not install a "rearward facing" child seat on the front passenger seat - risk of serious injury!

Front passenger airbag (OFF)



Fixed.

The front passenger airbag is deactivated.

The control is set to the "**OFF**" position.

A "rearward facing" child seat can be installed, unless there is a fault with the airbags (Airbags warning lamp on).

Parking sensors



Flashing.

The system detects an obstacle.



Fixed, accompanied by the display of a message and an audible signal.

The system has a fault.

Carry out (3).



Fixed, accompanied by the display of the message "**Parking Assistance Sensor blind: Clean sensor, see User Manual**".

The sensor is masked.

Stop as soon as it is safe to do so and switch off the ignition.

Clean the front and/or rear sensors.

Under-inflation



Fixed.

The pressure in one or more tyres is too low.

Check the pressure of the tyres as soon as possible.

Reinitialise the detection system after adjusting the pressure.



Under-inflation warning lamp flashing then fixed and Service warning lamp fixed.

The tyre pressure monitoring system is faulty. Under-inflation detection is no longer monitored. Check the tyre pressures as soon as possible and carry out (3).

Stop & Start (Petrol or Diesel)



Fixed, accompanied by the display of a message.

The Stop & Start system has been deactivated manually.

The engine will not switch off at the next traffic stop.



Fixed.

The Stop & Start system has been deactivated automatically.

The engine will not switch off at the next traffic stop, if the exterior temperature is:

- below 0°C.
- above +35°C.

For more information, refer to the **Driving** section.



Flashing then fixed, accompanied by a message.

The system has a fault.

Carry out (3).

Automatic headlamp dipping



Fixed, accompanied by an audible signal and a message.

A function or camera malfunction is detected.

Carry out (2).

Rear foglamps



Fixed.

The lamps are on.

Green warning/indicator lamps



Fixed.

The system has been activated, but the conditions for regulation are not met (gradient, speed too high, gear engaged).



Flashing.

The function is regulating the speed of the vehicle.

The vehicle is being braked; the brake lamps come on during the descent.

Stop & Start (Petrol or Diesel)



Fixed.

When the vehicle stops, the Stop & Start system puts the engine into STOP mode.



Flashing temporarily.

STOP mode is momentarily unavailable or START mode is automatically triggered.

For more information, refer to the **Driving** section.

Vehicle ready to drive (Electric)



Fixed, accompanied by an audible signal when it comes on.

The vehicle is ready to drive and the thermal comfort systems are available.

The indicator lamp goes out upon reaching a speed of approximately 3 mph (5 km/h) and lights up again when the vehicle stops moving. The lamp will go out when you switch off the motor and exit the vehicle.

Lane positioning assist



Fixed.

The function has been activated.

All conditions have been met: the system is operating.

For more information, refer to the **Driving** section.

Automatic wiping



Fixed.

Automatic windscreen wiping is activated.

Direction indicators



Flashing with audible signal.

The direction indicators are on.

Sidelamps



Fixed.
The lamps are on.

Dipped beam headlamps



Fixed.
The lamps are on.

Automatic headlamp dipping



Fixed.
The function has been activated via the touch screen.

The lighting control stalk ring is in the "AUTO" position.

For more information, refer to the **Lighting and visibility** section.

Blue warning/indicator lamps

Main beam headlamps



Fixed.
The lamps are on.

Black/white warning lamps

Hill Assist Descent Control



Fixed.
(grey)

The function has been activated, but is currently paused because the speed is too high.

Reduce the vehicle speed to below 19 mph (30 km/h).

Foot on the brake



Fixed.
Insufficient or no pressure on the brake pedal.

With the EAT6 automatic gearbox, with the engine running, before releasing the parking brake, to move out of position **P**.

With the EAT8 automatic gearbox or the drive selector, it may be necessary to depress the brake pedal to unlock the gearbox from mode **N**. This warning lamp will remain on if you attempt to release the parking brake without depressing the brake pedal.

Automatic gearbox (EAT8) or Drive selector (Electric)



Fixed.
The automatic gearbox is locked.

The drive selector is locked.

You must press the **Unlock** button to unlock it.

Indicators

Service indicator

The servicing information is expressed in terms of distance (miles or kilometres) and/or time (months or days).

The alert is given at whichever of these two terms is reached first.

The servicing information is displayed in the instrument panel. Depending on the version of the vehicle:

- The distance recorder display line indicates the distance remaining before the next service is due, or the distance travelled since it was due preceded by the "-" sign.

- An alert message indicates the distance remaining, as well as the period before the next service is due or how long it is overdue.

i The value indicated is calculated according to the distance covered and the time elapsed since the last service. The alert may also be triggered close to a due date. In accordance with the vehicle's maintenance plan, the service may consist of either:

- A yearly visit.
- A complete service.

Service spanner



On temporarily when the ignition is switched on.

Between 1,860 and 620 miles (3,000 and 1,000 km) or 60 and 21 days remain before the next service is due.



Fixed, when the ignition is switched on. The next service is due in less than 620 miles (1,000 km) or 21 days.

Have your vehicle serviced very soon.

Service spanner flashing



Flashing then fixed, when the ignition is switched on.

(With BlueHDi Diesel engines, associated with the Service warning lamp.)

The servicing interval has been exceeded.

Have your vehicle serviced as soon as possible.

Resetting the service indicator

The service indicator must be reset after each service.

If you have serviced your vehicle yourself:

- ▶ Switch the ignition off.

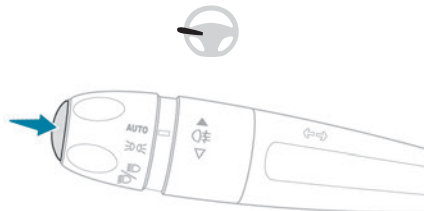

- ▶ Press and hold the button located on the end of the lighting control stalk.
- ▶ Without pressing the brake pedal, press the **START/STOP** button once; a temporary display window appears and a countdown begins.
- ▶ When the display indicates **=0**, release the lighting control stalk button; the spanner symbol disappears.

i If you disconnect the battery following this operation, lock the vehicle and wait at least 5 minutes for the reset to be registered.

Reminder of the servicing information

With Touch screen 10" & Bluetooth Radio & Telephone



Service information is accessible by pressing the "**Check**" button in the **Driving** touch screen menu.

With PEUGEOT i-Connect Advanced - PEUGEOT i-Connect



Service information is accessible using the **Settings > Vehicle** application on the touch screen.

- ▶ Then select **Safety > Diagnostics**.

Engine oil level indicator

(Depending on version)

On versions fitted with an electric gauge, the engine oil level status is displayed on the instrument panel for a few seconds when the ignition is switched on, after the servicing information.

i The level read will only be correct if the vehicle is on level ground and the engine has been off for more than 30 minutes.

Low oil level

This is indicated by the display of "**OIL**" or by the message "**Oil level incorrect**" (depending on the instrument panel), accompanied by the lighting of the Service warning lamp and an audible signal.

If a low oil level is confirmed by a check using the dipstick, the level must be topped up to avoid damage to the engine.

For more information on **Checking levels**, refer to the corresponding section.

Oil gauge malfunction

This is indicated by the display of "**OIL_ _**" or by the message "**Oil level measurement invalid**" (depending on the instrument panel), accompanied by the lighting of the Service warning lamp and an audible signal.

Consult a PEUGEOT dealer or a qualified workshop.

! In the event of a malfunction of the electric gauge, the oil level is no longer monitored.

If the system is faulty, you must check the engine oil level using the manual dipstick located in the engine compartment.

For more information on **Checking levels**, refer to the corresponding section.

Coolant temperature indicator

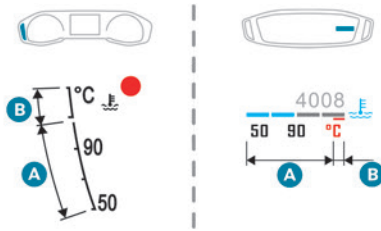

With the engine running:

- In zone **A**, the temperature is correct.
- In zone **B**, the temperature is too high. The associated warning lamp and the **STOP** warning lamp light up in red on the instrument panel, accompanied by the display of a message and an audible signal.

You must stop the vehicle as soon as it is safe to do so.

Wait a few minutes before switching off the engine.

! After switching off the ignition, carefully open the bonnet and check the coolant level.

i For more information on **Checking levels**, refer to the corresponding section.

AdBlue® range indicators (BlueHDi)

The Diesel BlueHDi engines are equipped with a system that associates the SCR (Selective Catalytic Reduction) emissions control system and the Diesel particle filter (DPF) for the treatment of exhaust gases. They cannot function without AdBlue® fluid.

When the level of AdBlue® falls below the reserve level (between 1,500 and 0 miles (2,400 and 0 km)), a warning lamp lights up when the ignition is switched on and an estimate of the distance that can be travelled before engine starting is prevented is displayed in the instrument panel.

! The engine starting prevention system required by regulations is activated automatically once the AdBlue® tank is empty. It is then no longer possible to start the engine until the minimum level of AdBlue® has been topped up.

Manual display of driving range

(With matrix instrument panel and digital instrument panel)

While the driving range is greater than 1,500 miles (2,400 km), it is not displayed automatically.

With Touch screen 10" & Bluetooth Radio & Telephone



Driving range information is accessible by pressing the "**Check**" button in the **Driving** touch screen menu.

With PEUGEOT i-Connect Advanced - PEUGEOT i-Connect



Driving range information is accessible using the **Settings > Vehicle** application on the touch screen.





► Then select **Safety > Diagnostics**.

Actions required related to a lack of AdBlue®

The following warning lamps light up when the quantity of AdBlue® is below the reserve level: driving range of 1,500 miles (2,400 km). Together with the warning lamps, messages regularly remind you of the need to top up to avoid engine starting being prevented. Refer to the **Warning and indicator lamps** section for details of the messages displayed.



For more information on **AdBlue® (BlueHDi)** and in particular on topping up, refer to the corresponding section.

Warning/indicator lamps on	Action	Remaining range
	Top up.	Between 1,500 miles and 500 miles (2,400 km and 800 km)
	Top up as soon as possible.	Between 500 miles and 62 miles (800 km and 100 km)
	A top-up is vital , there is a risk that the engine will be prevented from starting.	Between 62 miles and 0 miles (100 km and 0 km)
	To be able to restart the engine, add at least 10 litres of AdBlue® to the tank.	0 miles (km)

i Taking into account of top-up
Top-up detection may not be instantaneous after addition. It may take a few

minutes of driving before the top-up detection is effective.

Malfunction of the SCR emissions control system

Malfunction detection



If a malfunction is detected, these warning lamps come on, accompanied by an audible signal and the display of an **"Emissions control fault"** or **"NO START IN"** message.

The alert is triggered while driving when the fault is detected for the first time, and thereafter when switching on the ignition for subsequent journeys, for as long as the cause of the fault persists.

i If the fault is temporary, the alert disappears during the next journey, after self-diagnostic checks of the SCR emissions control system.

Malfunction confirmed during the permitted driving phase (between 685 miles and 0 miles (1,100 km and 0 km))

If the fault indication is still displayed permanently after 31 miles (50 km) of driving, the fault in the SCR system is confirmed.

The AdBlue warning lamp flashes and a message is displayed (**"Emissions control fault: starting prevented in X miles (kms)"** or **"NO START IN X miles (kms)"**), indicating the driving range in miles or kilometres. While driving, the message is displayed every 30 seconds. The alert is repeated when switching on the ignition. You can continue driving for up to 685 miles (1,100 km) before the **engine starting prevention** system is triggered.

! Have it checked by a PEUGEOT dealer or a qualified workshop.

Starting prevented

Every time the ignition is switched on, the message **"Emissions control fault: Starting prevented"** or **"NO START IN"** is displayed.

! **To restart the engine**
Contact a PEUGEOT dealer or a qualified workshop.

Power indicator (Electric)

The power indicator shows in real time the power demanded from the vehicle.

For electric versions

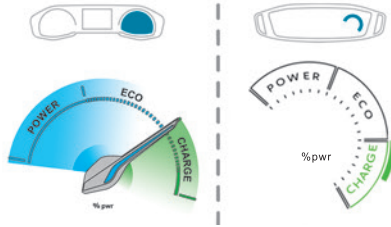

CHARGE Traction battery charging during deceleration and braking.

ECO Moderate energy consumption and optimised driving range.

POWER Energy consumption by the drive train during acceleration.

NEUTRAL

When the ignition is switched on, the vehicle's electric drive train neither consumes nor generates energy; after sweeping over the indicator, the needle or the cursor returns to its "neutral" position: between **ECO** and **CHARGE**.

i With the ignition off, opening the driver's door activates the indicator, which moves to the "neutral" position: between **ECO** and **CHARGE**.

Charge level indicator (Electric)

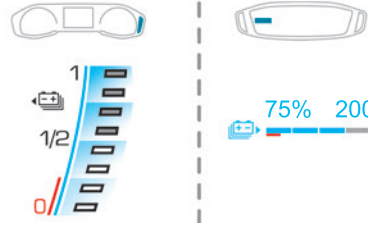

The traction battery's actual charge level and the remaining range are displayed continuously when the vehicle is started.

i With the ignition off, opening the driver's door activates the indicator.

Associated warning lamps

Two successive alert levels indicate that the energy available has dropped to a low level:

1st level: Reserve

 The state of charge of the traction battery is low.

Fixed and indicator in the red zone, accompanied by an audible signal.

► View the remaining range on the instrument panel.

► Put the vehicle on charge as soon as possible.

2nd level: Critical



The state of charge of the traction battery is critical.

Fixed, together with the reserve warning lamp, accompanied by an audible signal.

► You must put the vehicle on charge.

! The remaining range is no longer calculated. The drive train power gradually decreases. The heating and air conditioning are switched off (even if the needle or cursor indicating their consumption is not at the "ECO" position).

Thermal comfort consumption indicator (Electric)

(Depending on version)



The gauge shows the consumption of the traction battery's electrical energy by the thermal comfort devices in the passenger compartment. With a digital instrument panel, the gauge only appears in "Personal" mode.

The devices in question are the heating and air conditioning systems.

This equipment can be used:

- If the vehicle is not plugged in, when the **READY** lamp is lit.
- If the vehicle is plugged in, when the ignition is switched on ("Lounge" mode).

Selecting **ECO** mode limits the performance of some of this equipment. The needle or cursor on the thermal comfort consumption indicator then moves into the **"ECO"** zone.

I To quickly heat or cool the passenger compartment, feel free to temporarily select the maximum heating or cooling setting.

When the heating is on maximum, the gauge on the thermal comfort consumption indicator is in the **MAX** zone. When the air conditioning is on maximum, it stays in the **ECO** zone.

Excessive use of thermal comfort equipment, particularly at low speed, can significantly decrease the vehicle's range.

Remember to optimise equipment settings upon achieving the desired level of comfort, and adjust them if necessary whenever you start the vehicle.

After an extended period without using the heating, you may notice a slight odour during the first few minutes of use.

Manual test

This function allows you to check certain indicators and display the alerts log.

With Touch screen 10" & Bluetooth Radio & Telephone



It can be accessed via the **"Check"** button in the **Driving** touch screen menu.

With PEUGEOT i-Connect Advanced - PEUGEOT i-Connect



It can be accessed via the **Settings> Vehicle** touch screen application.

- ▶ Select **Safety > Diagnostics**.

The following information is displayed on the instrument panel:

- Tyre pressures.
- Engine oil level (depending on engine).
- Next service due.
- Driving range associated with the AdBlue® and the SCR system (BlueHDi Diesel).
- Current alerts.

I This information is also displayed automatically every time the ignition is switched on.

Total distance recorder

The total distance recorder measures the total distance travelled by the vehicle since its initial registration.

With the ignition on, the total distance is displayed at all times. It remains displayed for 30 seconds after switching off the ignition. It is displayed when the driver's door is opened, and when the vehicle is locked or unlocked.

I When travelling abroad, you may have to change the distance units (miles or km): the displayed speed must be in the local country's official unit (mph or km/h). The unit is changed via the screen's configuration menu, with the vehicle stationary.

Lighting dimmer

This system allows the brightness of the instruments and controls to be adjusted manually to suit the ambient light level.

With Touch screen 10" & Bluetooth Radio & Telephone



▶ Press **Settings** from the status bar or from the menus buttons.





▶ Select **"Brightness"** or **"Screen configuration"**,

depending on equipment.



▶ Adjust the instrument panel and screen brightness by using the arrows or moving the slider.

 /  ► Press this button to save and exit, depending on equipment.

You can also switch off the screen:

 ► Press **Settings** from the status bar or from the menus buttons.

 ► Select **"Turn off screen"** or **"Dark"**, depending on equipment.

The screen goes off completely.

► Press the screen again (anywhere on its surface) to turn it on.

With PEUGEOT i-Connect Advanced - PEUGEOT i-Connect

 It is configured in the **Settings > Brightness** touch screen application.

► In the **"Cockpit"** category, press or move the slider to the desired setting.

Trip computer

Displays information related to the current trip (range, fuel consumption, average speed, etc.).

Data displayed on the instrument panel

With instrument panels with dials

Pressing the end of the wiper control stalk displays the trip computer data.

With digital instrument panel

Trip computer data is permanently displayed when the **"Personal"** display mode is selected.

In all other display modes, pressing the end of the wiper control stalk will cause this data to appear temporarily in a specific window.

Display of the various tabs

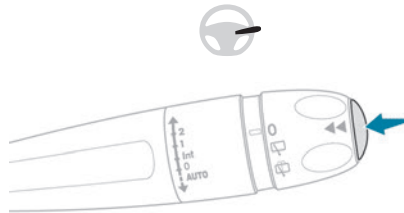

► Pressing the button located on the end of the wiper control stalk displays the following tabs in turn:

- Current information:
 - Driving range (Petrol or Diesel).
 - Current fuel consumption.
 - Stop & Start time counter (Petrol or Diesel).
- Trips "1" then "2":
 - Average speed.
 - Average fuel consumption.
 - Distance travelled.

Trip reset

 ► When the desired trip is displayed, press the button on the end of the wiper control stalk for more than 2 seconds. Trips "1" and "2" are independent and are used in the same way.

Definitions

Range

(miles or km)

(Traction battery charge level percentage)

(Electric)

 Distance that can still be travelled with the fuel remaining in the tank (based on the average fuel consumption over the last few miles (kilometres) travelled).

This value may vary following a change in driving style or terrain, leading to a significant change in current fuel consumption.

When the range falls below 19 miles (30 km), dashes are displayed.

After filling with at least 5 litres of fuel, the range is recalculated and is displayed if it exceeds 62 miles (100 km).



Dashes appearing permanently in place of numbers while driving indicates a malfunction.

Consult a PEUGEOT dealer or a qualified workshop.

Current consumption

(mpg or l/100 km or km/l)

(miles/kWh or kWh/100 km or km/kWh) (Electric)

 /  Calculated during the last few seconds.

This function is only displayed at speeds above 19 mph (30 km/h) (Petrol or Diesel).

Average consumption

(mpg or l/100 km or km/l)
(miles/kWh or kWh/100 km or km/kWh) (Electric)



Calculated since the last trip computer reset.

Average speed

(mph or km/h)



Calculated since the last trip computer reset.

Distance travelled

(miles or km)



Calculated since the last trip computer reset.

Stop & Start time counter



(minutes/seconds or hours/minutes)

If your vehicle is fitted with the Stop & Start function, a time counter calculates the time spent in STOP mode during a journey.

The time counter is reset each time the ignition is switched on.

Touch screen

This system gives access to the following elements:

- Permanent display of the time and outside temperature (a blue warning lamp appears if there is a risk of ice).
- Heating/air conditioning system controls.

- Vehicle functions and equipment setting menus.
- Audio system and telephone controls and display of related information.
- Display of visual manoeuvring aid functions (visual parking sensor information, etc.).
- Internet services and display of related information.
- Navigation system controls and display of related information (depending on version).

! For safety reasons, always stop the vehicle before performing operations that require sustained attention.

Some functions are not accessible while driving.

Recommendations

This screen uses capacitive sensing technology.

- Do not use pointed objects on the touch screen.
- Do not touch the touch screen with wet hands.
- Use a soft, clean cloth to clean the touch screen.

With Touch screen 10" & Bluetooth Radio & Telephone

Principles



Access to the menus



Direct access to the **Climate** menu



Direct access to the **Driving** menu

► Use the buttons arranged below the touch screen to access the menus, then press the buttons that appear on the touch screen.

Some menu may display across two pages: press the "**OPTIONS**" button to access the second page.



After a few moments with no action on the second page, the first page is displayed automatically.

To deactivate/activate a function, select "**OFF**" or "**ON**".



Configuring a function



Access to additional information on the function



Confirm



Return to the previous page or confirm



Volume adjustment/mute

Menus

i Press the touch screen with three fingers to show all of the menu buttons.

i For more information about the menus, refer to the sections describing the audio and telematics systems.



Radio/Media



Climate

Settings for temperature, air flow, etc.

For more information on **Automatic air conditioning**, refer to the corresponding section.



Navigation via CarPlay® or Android Auto (Depending on equipment)



Driving

Activation, deactivation and settings for certain functions.

The functions are organised in 2 tabs: "**Driving functions**" and "**Vehicle settings**".



Telephone



Applications

Access to certain configurable equipment.

With PEUGEOT i-Connect Advanced - PEUGEOT i-Connect

Main controls



Access to one of the home pages

Return to the first home page



Direct access to the **Climate** application



Direct access to the **Shortcuts for driving aids**

► Swipe down from the upper edge of the touch screen to access a list of quick settings (e.g.

Brightness, Diagnostics).

► Depending on the pages displayed on the screen, with or without the context menu, scroll the text by swiping with your finger, as with a smartphone.



From any page, press the touch screen with three fingers to display the applications wall.



Show/Hide context menu



Return to the previous page

► To change the status of a function, press the description for the corresponding line (change confirmed by the slider moving to the right/left: function activated/deactivated).



Access additional information on the function



Access to function parameters



Adding/Removing shortcuts



Short press, ignition off: system on/off.

Short press, ignition on: mute/restore sound.

Long press, ignition on: start standby mode (mute sound, screens and clock display off).
Rotation: volume adjustment.

Applications



Press this button to access the applications wall.

To obtain information about the other applications not listed here, refer to the sections describing the audio and telematic systems.



ADAS

Activation/Deactivation and configuration of the driving aid functions.



Climate

Settings for temperature, air flow, etc.

For more information on **Automatic air conditioning**, refer to the corresponding section.



Settings

Main settings for the audio system, touch screen and digital instrument panel.

Activation/Deactivation and configuration of the exterior lighting, vehicle access and safety functions.



Energy

Access to the charging system features (energy flow, consumption statistics, deferred charging).

Energy application

Flow

The page displays a real-time representation of the electric drive train's operation.

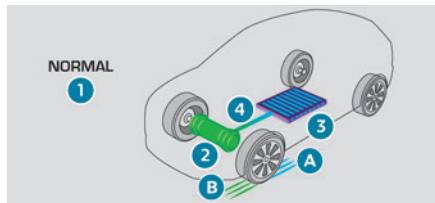

1. Active driving mode
2. Electric motor
3. Estimated traction battery charge level
4. Energy flows

The energy flows have a specific colour for each type of driving:

- A. Blue: energy consumption
- B. Green: energy recovery

Statistics

This page shows electrical energy consumption statistics.

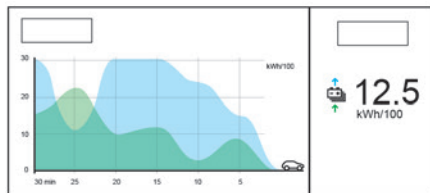

- Blue graph: energy consumed directly from the traction battery.
- Green graph: energy regenerated during deceleration and braking phases used to recharge the traction battery.

The average result for the current trip is stated in kWh/100 km.

Charging

This page allows you to programme deferred charging.

For more information on **Charging the traction battery (Electric)**, refer to the corresponding section.

Remotely operable additional functions (Electric)

(Depending on country of sale)



The following functions are available from the **MYPEUGEOT APP** application, which is accessible from a smartphone:

- Managing the traction battery charging (deferred charging).
- Managing the temperature pre-conditioning.
- Viewing statistics (depending on availability).
- Viewing the state of charge and range of the vehicle.

Installation procedure

- ▶ Download the **MYPEUGEOT APP** application from the appropriate online store for your smartphone.
- ▶ Create an account.
- ▶ Enter the vehicle identification number (available on the vehicle registration certificate).

For more information on **Identification markings**, refer to the corresponding section.

i Network coverage

In order to be able to use the various remotely operable features, ensure that your

vehicle is located in an area covered by the mobile network.

A lack of network coverage may prevent communication with the vehicle (for example, if it is in an underground car park). In such cases, the application will display a message indicating that the connection with the vehicle could not be established.

Remote control / Key

Remote control function

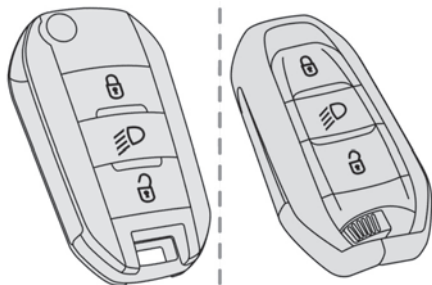

The remote control can be used to perform the following remote functions (depending on version):

- Unlocking/Locking/Deadlocking the vehicle.
- Remote operation of lighting.
- Folding/Unfolding the door mirrors.
- Activating/Deactivating the alarm.
- Locating the vehicle.
- Closing the windows.
- Activating the vehicle's electronic immobiliser.

Back-up procedures allow the vehicle to be locked/unlocked in the event of a failure of the remote control, the central locking, the battery, etc. For more information on the **Back-up procedures**, refer to the corresponding section.

Built-in key

Using the remote control built-in key, you can perform the following operations (depending on version):

- Unlocking/Locking/Deadlocking the vehicle.
- Activation/Deactivation of the manual child lock.
- Activation/Deactivation of the front passenger airbag.
- Back-up Unlocking/Locking of the doors.
- Switching on the ignition and starting/switching off the engine.

Without Keyless Entry and Start

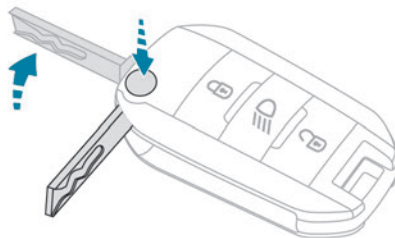

- ▶ To unfold or fold the key, press the button.

With Keyless Entry and Start

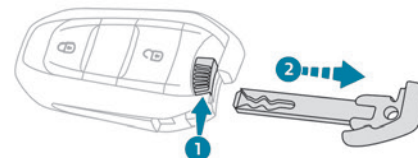

- ▶ To eject the key or put it back in place, pull and hold the button.

! Once the built-in key is ejected, always keep it with you to be able to carry out the corresponding back-up procedures.

Unlocking the vehicle



With Touch screen 10" & Bluetooth Radio & Telephone



Selective unlocking is configured in the **Driving** touch screen menu.

With PEUGEOT i-Connect Advanced - PEUGEOT i-Connect



Selective unlocking is configured in the **Settings > Vehicle** touch screen application.

Complete unlocking

- ▶ If the selective unlocking is deactivated, press the unlocking button.

Selective unlocking

Driver's door

- ▶ Press the unlocking button.

The driver's door and the fuel filler flap are unlocked (Petrol or Diesel).

The driver's door and the charging flap are unlocked (Electric).

- ▶ Press it **again** to unlock the other doors and the boot.

The charging nozzle can be unplugged on the second press.

Complete or selective unlocking and alarm deactivation is confirmed by the flashing of the sidelamps and/or daytime running lamps.

Depending on version, the door mirrors unfold.

Locking the vehicle



Normal locking

- ▶ Press the locking button.

The locking, and the activation of the alarm depending on version, is confirmed by the lighting of the direction indicators.

Depending on version, the door mirrors fold.

i An access (door or boot) that is not properly closed prevents locking of the vehicle. However, if the vehicle is fitted with an alarm, it will be activated after 45 seconds. If the vehicle is unlocked but the doors or boot are not subsequently opened, the vehicle

will automatically lock itself again after about 30 seconds. If the vehicle is fitted with an alarm, it will be reactivated automatically.

Deadlocking



! Deadlocking renders the interior door controls inoperative. It also disables the central locking button.

The horn remains operational.

Never leave anyone inside the vehicle when it is deadlocked.

- ▶ Press the locking button.
 - ▶ Press the locking button again within 3 seconds to deadlock the vehicle (confirmed by the temporary lighting of the direction indicators).
- For the vehicles equipped with the Proximity Keyless Entry and Start system, a double audible signal indicates that the vehicle is not deadlocked.

Closing the windows



Holding the locking button pressed for more than 3 seconds closes the windows.

! When closing windows, ensure that no person or object could prevent their correct closure.

To leave the windows partly open on versions with alarm, you must first deactivate the interior volumetric monitoring.

For more information on the **Alarm**, refer to the corresponding section.

Locating the vehicle

This function helps you to spot your vehicle from a distance, with the vehicle locked:

- The direction indicators or sidelamps and/or daytime running lamps, depending on version, flash for approximately 10 seconds.
- The door mirror spotlamps come on.
- The courtesy lamps come on.



- ▶ Make a long press on this button.

Remote lighting of the lamps

(Depending on version)



- ▶ Press this button. The sidelamps, dipped beam headlamps, number plate lamps and door mirror spotlamps come on for 30 seconds.

Pressing again before the end of the timed period switches off the lamps immediately.

Advice

! Remote control

The remote control is a sensitive, high-frequency device; avoid handling it in your pocket, due to the risk of unintentionally unlocking the vehicle.

Avoid pressing the remote control buttons while out of range of the vehicle, due to the risk of rendering the remote control inoperative. It would then be necessary to reset it.

The remote control does not work when the key is in the ignition switch, even when the ignition is switched off.

! Anti-theft protection

Do not modify the electronic vehicle immobiliser, as this might result in malfunctions.

For vehicles with a key ignition switch, remember to remove the key and turn the steering wheel to engage the steering lock.

! Locking the vehicle

Driving with the doors locked could make it more difficult for the emergency services to enter the passenger compartment in an emergency.

As a safety precaution, remove the key from the ignition or take the electronic key with you when leaving the vehicle, even for a short time.

i Purchasing a second-hand vehicle

Have the key codes memorised by a PEUGEOT dealer, to ensure that the keys in your possession are the only ones able to start the vehicle.

Proximity Keyless Entry and Start

This is a Keyless Entry and Start system. It enables automatic vehicle locking/unlocking simply by detecting the electronic key.

As long as the driver has the electronic key on their person, the vehicle unlocks as they approach and locks when they walk away.

Key recognition zones:

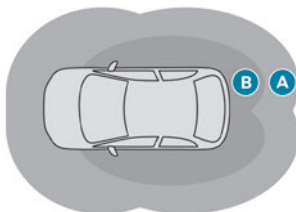

Zone A: automatic locking on moving away from the vehicle (about 2 metres from the vehicle).

Zone B: automatic unlocking and welcome lighting on approaching the vehicle (between 1 and 2 metres from the vehicle).

For more information on **Welcome lighting**, please refer to the corresponding section.

Activation/Deactivation

With Touch screen 10" & Bluetooth Radio & Telephone



The automatic functions are configured via the **Driving** touch screen menu.

With PEUGEOT i-Connect Advanced - PEUGEOT i-Connect



The automatic functions are configured in the **Settings > Vehicle** touch screen application.

Unlocking the vehicle

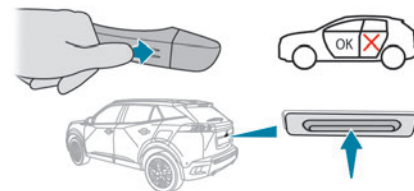

With Touch screen 10" & Bluetooth Radio & Telephone



Selective unlocking is configured in the **Driving** touch screen menu.

With PEUGEOT i-Connect Advanced - PEUGEOT i-Connect



Selective unlocking is configured in the **Settings > Vehicle** touch screen application.

Complete unlocking

The vehicle (doors and boot) unlocks:

- ▶ Either automatically as the driver approaches in zone **B**, if the automatic functions are activated.
- ▶ Or by gently pressing the driver's door handle or the button on the boot.

Unlocking, and alarm deactivation (depending on version), is confirmed by the flashing of the sidelamps and/or daytime running lamps. Depending on version, the door mirrors unfold.

i If the electronic key remains around the vehicle (zones **A** or **B**) for more than 15 minutes without action, the automatic functions are deactivated. To unlock or lock the vehicle, use the remote control or press one of the door handles. If using the door handle does not lock/unlock the vehicle, bring the electronic key closer and repeat the desired action.

Selective unlocking

Driver's door

It operates:

- ▶ Either automatically when approaching the driver's door, if the automatic functions are activated.
- ▶ Or by gently pressing the driver's door handle.

The driver's door and the fuel filler flap are unlocked (Petrol or Diesel).

The driver's door and the charging flap are unlocked (Electric).

- ▶ Once inside the vehicle, to unlock all accesses, press the central locking button or pull the opening control on any door.

Selective unlocking of the boot

The boot unlocks automatically as you approach the rear of the vehicle.

- ▶ Press the tailgate control to open the boot. The doors remain locked.

Locking the vehicle

Normal locking

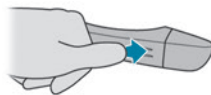

With the doors and boot closed, the vehicle locks:

- ▶ Either automatically, upon leaving zone **A**, if the automatic functions are activated.
- ▶ Or by gently pressing the driver's door handle.

Locking is confirmed by the lighting of the direction indicators, and by a double audible signal when the vehicle is locked upon walking away.

! The alarm does not activate when locking automatically from a distance (the direction indicators do not light up).

It is not possible to lock the vehicle if the electronic key is left inside the vehicle.

! For safety and theft protection reasons, never leave the electronic key in the vehicle, even when you are close to it.

Deadlocking



! Deadlocking renders the interior door controls inoperative. It also deactivates the central locking button. The horn remains operational.

Never leave anyone inside the vehicle when it is deadlocked.

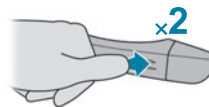

- ▶ Gently press the driver's door handle to lock the vehicle.
- ▶ Press it again within 3 seconds to deadlock the vehicle (confirmed by the temporary lighting of the direction indicators). A double audible signal indicates that the vehicle is not deadlocked.

Advice

i If one of the doors or the boot is still open or if the electronic key for the Keyless Entry and Start system has been left inside the vehicle, central locking will not take place.

i If the vehicle is unlocked but the doors or boot are not subsequently opened, the vehicle will automatically lock itself again after about 30 seconds. If the vehicle is fitted with an alarm, it will be reactivated automatically.

i Automatic folding/unfolding of the door mirrors is configured in the touch screen. For more information on **Mirrors**, refer to the corresponding section.

! As a safety measure, never leave the vehicle, even for a short time, without taking the Keyless Entry and Start system's electronic key with you. Be aware of the risk of theft of the vehicle if the key is present in one of the defined areas while the vehicle is unlocked.

! In order to preserve the battery in the electronic key and the vehicle's battery:

- The unlocking on approach function (zone **B**) automatically switches to hibernation mode after several days (approximately one week) without being used. To unlock the

vehicle, use the remote control or press on one of the front door handles. The next time the vehicle is started, the automatic unlocking and locking functions will be reactivated.

- If the welcome lighting is triggered several times in succession without the vehicle subsequently being started, it will be deactivated.

- All "hands-free" functions switch to hibernation mode after 21 days without being used. To restore these functions, unlock the vehicle using the remote control and start the engine.

i Electrical interference

The electronic key may not work if it is close to an electronic device (e.g. mobile telephone (switched on or on standby), laptop computer, strong magnetic fields). If this occurs, move the electronic key away from the electronic device.

Central locking

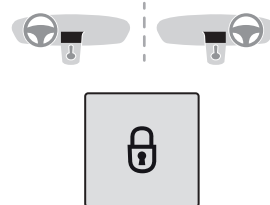

Manual

► Press this button to lock/unlock the vehicle (doors and boot) from inside the passenger compartment.

The indicator lamp comes on to confirm the central locking of the vehicle.

! Central locking does not take place if any of the doors are open.

i When locking/deadlocking from the outside

When the vehicle is locked or deadlocked from the outside, the indicator lamp flashes and the button is deactivated.

- After normal locking, pull one of the interior door controls to unlock the vehicle.
- After deadlocking, you must use the remote control, the "Keyless Entry and Start" system or the built-in key to unlock the vehicle.

Automatic (anti-intrusion security)

The doors and boot lock automatically while driving (speed above 6 mph (10 km/h)).

To deactivate/reactivate this function (activated by default):

▶ Press the button until a confirmation message appears.

i Transporting long or voluminous objects

Press the central locking control to drive with the boot open and the doors locked. Otherwise, every time the speed of the vehicle exceeds 6 mph (10 km/h), the sound of the locks rebounding will be heard and an alert will be displayed.

Back-up procedures

Lost keys, remote control, electronic key

Go to a PEUGEOT dealer with the vehicle's registration certificate, your personal identification documents and if possible, the label bearing the key code.

The PEUGEOT dealer will be able to retrieve the key code and the transponder code, enabling a new key to be ordered.

Complete unlocking/locking of the vehicle with the key

Use this procedure in the following situations:

- Remote control battery discharged.
- Remote control malfunction.
- Vehicle battery discharged.
- Vehicle in an area subject to strong electromagnetic interference.

In the first case, change the remote control battery.

In the second case, reinitialise the remote control.

Refer to the corresponding sections.

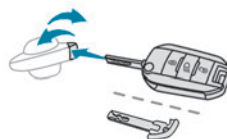

- ▶ Insert the key into the door lock.
- ▶ Turn the key towards the front/rear to unlock/lock the vehicle.
- ▶ Turn the key towards the rear again within 3 seconds to deadlock the vehicle.

i If the vehicle is fitted with an alarm, it will not be activated when locking with the key.

If the alarm is activated, the siren sounds when the door is opened; switch on the ignition to stop it.

Central locking not functioning

Use these procedures in the following cases:

- Central locking malfunction.
- Battery disconnected or discharged.

! In the event of a malfunction of the central locking system, the battery must be disconnected to ensure that the vehicle is locked fully.

Driver's or front left-hand door (depending on version)

- ▶ Insert the key into the door lock.
- ▶ Turn the key towards the rear of the vehicle to lock it, or towards the front to unlock it.

Other doors

Unlocking

- ▶ Pull the interior door opening control.

Locking

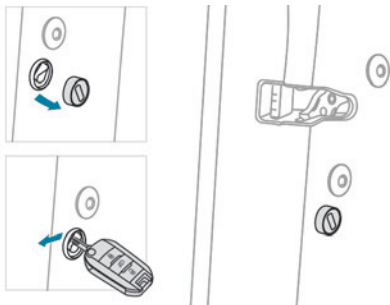

- ▶ Open the doors.
- ▶ For the rear doors, check that the child lock is not on.

Refer to the corresponding section.

- ▶ **Remove the black cap**, located on the edge of the door, using the key.
- ▶ Insert the key into the socket without forcing it, then turn the latch towards the inside of the door.
- ▶ Remove the key and refit the black cap.
- ▶ Close the doors and check from the outside that the vehicle is locked.

Changing the battery



If the battery is flat, this warning lamp comes on, accompanied by an audible signal and the display of a message.

Battery type: CR2032/3 volts.

Without Keyless Entry and Start

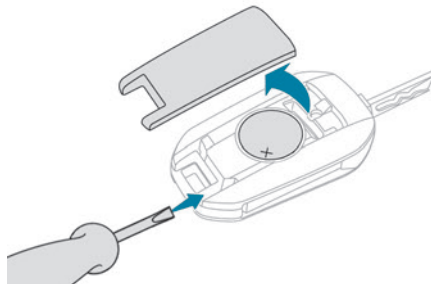

With Keyless Entry and Start

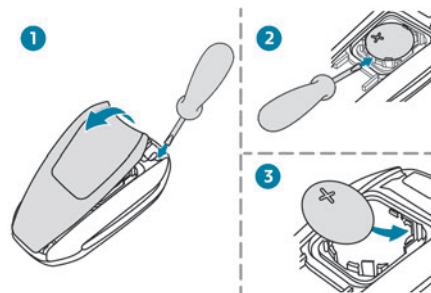

- ▶ Unclip the cover by inserting a small screwdriver in the slot and lift the cover.
- ▶ Remove the flat battery from its housing.
- ▶ Put the new battery in place, respecting the polarity. Start by inserting it into the contacts

located in the corner, then clip the cover onto the unit.

- ▶ Reinitialise the remote control.

For more information on **Reinitialising the remote control**, refer to the corresponding section.



Do not throw remote control batteries away, as they contain metals that are harmful to the environment. Take them to an approved disposal point.



This equipment contains a button type battery.

Do not swallow the battery. Risk of chemical burns!

Swallowing the battery can cause serious internal burning in only 2 hours and can be fatal.

If batteries have been swallowed or inserted into a part of the body, seek immediate medical advice.

Keep new and used batteries out of the reach of children.

If the battery compartment does not close properly, stop using the product and keep it out of the reach of children.



Risk of explosion if the battery is replaced with an incorrect type!
Replace the battery with the same type.

! Risk of explosion or leaking of inflammable liquid or gas!

Do not use in/store in/place in an environment where the temperature is extremely high or where the pressure is extremely low due to very high altitude.

Do not try to burn, crush or cut a used battery.

Reinitialising the remote control

Following replacement of the battery or in the event of a fault, it may be necessary to reinitialise the remote control.

Without Keyless Entry and Start

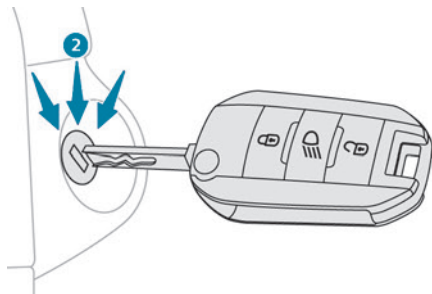

- ▶ Switch the ignition off.
- ▶ Turn the key to position **2 (Ignition on)**.
- ▶ Immediately press the closed padlock button for a few seconds.

- ▶ Switch off the ignition and remove the key from the ignition switch.

The remote control is now fully operational again.

With Keyless Entry and Start

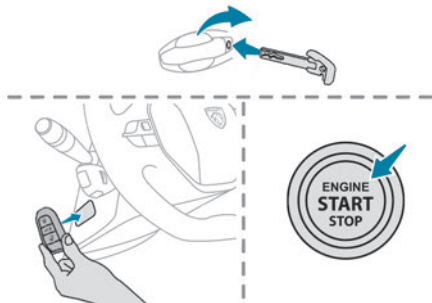

- ▶ Insert the mechanical key (incorporated into the remote control) into the lock to open the vehicle.
- ▶ Place the electronic key against the back-up reader on the steering column and hold it there until the ignition is switched on.
- ▶ **With a manual gearbox**, place the gear lever in neutral then fully depress the clutch pedal.
- ▶ **With an automatic gearbox or drive selector**, while in mode **P**, depress the brake pedal.
- ▶ Switch on the ignition by pressing the **"START/STOP"** button.

If the fault persists after reinitialisation, contact a PEUGEOT dealer or a qualified workshop without delay.

Doors

Opening

From outside

- ▶ After unlocking the vehicle or with the "Keyless Entry and Start" system electronic key in the recognition zone, pull the door handle.

From inside

- ▶ Pull the interior opening control of a door; this unlocks the vehicle completely.

- i** With selective unlocking activated:
 - Opening the driver's door unlocks the driver's door only (if the vehicle has not already been completely unlocked).
 - Opening one of the passenger doors unlocks the rest of the vehicle.

Closing



If a door is not properly closed, this warning lamp comes on accompanied by a message if the engine is running, and an audible signal when the vehicle is travelling at more than 6 mph (10 km/h).

Boot

Opening

- ▶ After unlocking the vehicle or just the boot (depending on version), press the opening control and then lift the tailgate.

Closing

- ▶ Lower the tailgate using one of the interior grab handles.

! In the event of a malfunction or if you experience difficulty opening or closing the tailgate, have it checked by a PEUGEOT dealer or a qualified workshop without delay, to avoid the issue deteriorating and prevent any risk of the tailgate dropping, potentially causing serious injury.

Back-up release

To manually unlock the boot in the event of a battery or central locking failure.

Unlocking

- ▶ Fold the rear seats to gain access to the lock from inside the boot.

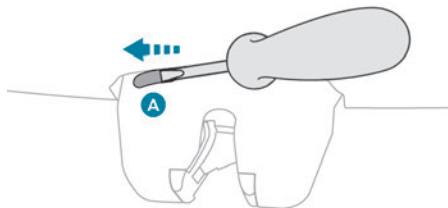

- ▶ Insert a small screwdriver into hole **A** of the lock to unlock the boot.
- ▶ Move the latch to the left.

Locking after closing

If the fault persists after closing again, the boot will remain locked.

i In the event of a fault with the central locking system, it is essential to disconnect the battery to lock the boot and so ensure complete locking of the vehicle.

Alarm

(Depending on version)



System which protects and provides a deterrent against theft and break-ins.

Exterior perimeter monitoring

The system checks for opening of the vehicle. The alarm is triggered if anyone tries to open a door, the boot or the bonnet, for example.

Interior volumetric monitoring

The system checks for any variation in volume in the passenger compartment. The alarm is triggered if anyone breaks a window, enters the passenger compartment or moves inside the vehicle.

Anti-tilt monitoring

The system checks for any change in the attitude of the vehicle.

The alarm goes off if the vehicle is lifted or moved.

i When the vehicle is parked, the alarm will not be triggered if the vehicle is knocked.

Self-protection function

The system checks whether any of its components are out of service.

The alarm is triggered if the battery, the central control or the siren wiring is put out of service or damaged.

! **Work on the alarm system**
Consult a PEUGEOT dealer or a qualified workshop.

Locking the vehicle with full alarm system

Activation

- ▶ Switch off the ignition and exit the vehicle.
- ▶ Lock or deadlock the vehicle using the remote control or by pressing on the driver's door handle.

When the monitoring system is active, the red indicator lamp in the button flashes once per second and the direction indicators come on for about 2 seconds.

The exterior perimeter monitoring is activated after 5 seconds and the interior volumetric and anti-tilt monitoring after 45 seconds.

! The alarm does not activate when locking automatically from a distance.

! **Door, boot or bonnet**
If an opening is not properly closed, the vehicle is not locked, but the exterior perimeter monitoring will be activated after 45 seconds, at the same time as the interior volumetric and anti-tilt monitoring.

Deactivation



- ▶ Press the remote control unlocking button.

or

- ▶ Unlock the vehicle by pressing the driver's door handle.

The monitoring system is deactivated: the indicator lamp in the button goes off and the sidelamps and/or the daytime running lamps flash for about 2 seconds.

i After unlocking using the remote control

If the vehicle automatically locks itself again (as happens if a door or the boot is not opened within 30 seconds of unlocking), the monitoring system is automatically activated.

Locking the vehicle with exterior perimeter monitoring only

Deactivate the interior volumetric and anti-tilt monitoring to avoid the unwanted triggering of the alarm, in certain cases such as:

- Slightly open window.
- Washing the vehicle.
- Changing a wheel.
- Towing the vehicle.
- Transport on a ship or ferry.

Deactivating the interior volumetric and anti-tilt monitoring

- ▶ Switch off the ignition and within 10 seconds press the alarm button until its red indicator lamp is on fixed.
- ▶ Get out of the vehicle.
- ▶ Immediately lock the vehicle using the remote control or the Keyless Entry and Start system.

Only the exterior perimeter monitoring is activated; the button's red indicator lamp flashes once every second.

i To take effect, this deactivation must be carried out after each time the ignition is switched off.

Reactivating the interior volumetric and anti-tilt monitoring

- ▶ Deactivate the exterior perimeter monitoring by unlocking the vehicle using the remote control or the Keyless Entry and Start system. The indicator lamp in the button goes off.
- ▶ Reactivate all monitoring by locking the vehicle using the remote control or the Keyless Entry and Start system. The red indicator lamp in the button once again flashes every second.

Triggering of the alarm

This is indicated by sounding of the siren and flashing of the direction indicators for 30 seconds.

Depending on the country of sale, certain monitoring functions remain active until the alarm has been triggered eleven times consecutively. When the vehicle is unlocked using the remote control or the Keyless Entry and Start system, rapid flashing of the red indicator lamp in the button informs you that the alarm was triggered

during your absence. When the ignition is switched on, this flashing stops.

Failure of the remote control

To deactivate the monitoring functions:

- ▶ Unlock the vehicle using the key in the driver's door lock.
- ▶ Open the door; the alarm is triggered.
- ▶ Switch on the ignition; this stops the alarm. The indicator lamp in the button goes off.

Locking the vehicle without activating the alarm

- ▶ Lock or deadlock the vehicle using the key (built-in the remote control) in the driver's door lock.

Malfunction

When the ignition is switched on, the fixed lighting of the red indicator lamp in the button indicates a system malfunction. Have it checked by a PEUGEOT dealer or a qualified workshop.

Automatic activation

(Depending on version)

The system is activated automatically 2 minutes after the last door or the boot is closed.

- ▶ To avoid triggering the alarm on entering the vehicle, first press the unlocking button on the remote control or unlock the vehicle using the "Keyless Entry and Start" system.

Electric windows

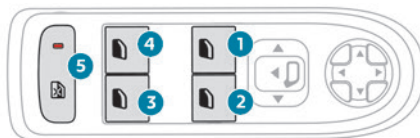

1. Left-hand front
2. Right-hand front
3. Right-hand rear
4. Left-hand rear
5. Deactivation of electric window controls located by rear seats

For more information on the **Electric child lock**, refer to the corresponding section.

Manual operation

- ▶ To open/close the window, press/pull the switch without passing the point of resistance; the window stops as soon as the switch is released.

Automatic operation

- ▶ To open/close the window, press/pull the switch past its resistance point: the window opens/closes completely when the switch is released. Operating the switch again stops the movement of the window.

i Window controls remain operational for approximately 45 seconds after switching off the ignition or after locking the vehicle. After that time, the controls are disabled. To reactivate them, switch on the ignition or unlock the vehicle.

Anti-pinch

If the window meets an obstacle while rising, it stops and immediately partially lowers again.

i **Overtaking of the anti-pinch**
After triggering the anti-pinch, check that there are no obstacles blocking the movement of the window. Try to close the window again. If the window closing is interrupted by the anti-pinch 3 times in a row (max. 10 seconds between each action), the anti-pinch function becomes inoperable. Without this protection, the window can only be closed manually - risk of injury!

Deactivating the rear controls for the rear electric windows

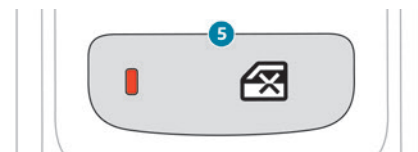

For your children's safety, ignition on or engine on, press control **5** to deactivate the controls for the rear electric windows, irrespective of their positions.

The red indicator lamp in the button comes on. The rear electric windows can still be controlled using the driver's controls.

i In the event of a serious impact, use of the rear electric window controls is re-enabled, if they had been deactivated.

Reinitialising the electric windows

After reconnecting the battery, or in the event of abnormal window movement, the anti-pinch function must be reinitialised.

i Automatic window closing is no longer available, only manual closing is possible. Remote window closing with the electronic key is also no longer available in this case.

The anti-pinch function is inoperable during the following sequence of operations.

For each window:

► Lower the window fully, then raise it; it will rise in steps of a few centimetres each time the control is pressed. Repeat the operation until the window is fully closed.

► Continue to pull the control for at least one second after the window reaches the closed position.

! If an electric window meets an obstacle during operation, the movement of the window must be reversed. To do this, press the relevant control.

When the driver operates the passengers' electric window controls, it is important to ensure that nothing can prevent the window from closing properly.

It is important to ensure that passengers use the electric windows correctly.

Pay particular attention to children when operating the windows.

Be aware of passengers and/or other persons present when closing windows remotely using the electronic key.

Do not put your head or arms through the open windows when the vehicle is moving - risk of serious injury!

Sunroof

The sunroof consists of a movable glass panel that slides over the roof and a blind that can be opened independently. Opening the sunroof automatically opens the blind.

► To operate the panoramic sunroof, use the button in the roof console.

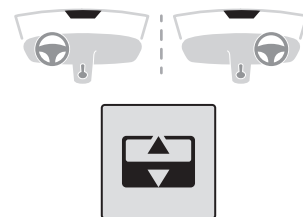

The sunroof can be operated when the ignition is turned on (if the battery is charged enough), with the engine running, in STOP mode of Stop & Start, and up to 45 seconds after turning off the ignition or after locking the vehicle.

Precautions

! Do not put your head or arms through the sunroof while the vehicle is moving - risk of serious injury!

! Ensure that any luggage or accessories carried on the roof bars do not interfere with the movement of the sunroof. Do not place heavy loads on the movable glass panel of the sunroof.

! If the sunroof is wet, following a rain shower or washing the vehicle, wait until it is completely dry before operating it. Do not operate the sunroof if it is covered by snow or ice - risk of damage!

Use only plastic scrapers to remove snow or ice from the sunroof.

! Regularly check the condition of the sunroof seals (e.g. presence of dust, dead leaves).

If using a car wash, check first that the roof is correctly closed and keep the high-pressure jet at least 30 centimetres from the seals.

! Never leave the vehicle with the sunroof open.

Operation

When opening the sunroof fully, the movable glass moves to a partially open position, then slides over the roof. Any intermediate position is possible.

! Before operating the sunroof control button, ensure that no object or person might prevent the movement.

Pay particular attention to children when operating the sunroof.

If something is trapped when operating the sunroof, reverse the movement of the sunroof by pressing the control button in question.

The driver must ensure that passengers use the sunroof correctly.

Any manual intervention on the position of the sunroof may disturb the anti-pinch device. Perform a reinitialisation.

Anti-pinch system

If the sunroof encounters an obstacle when closing, the movement is automatically reversed. The roof anti-pinch system is designed to be effective at speeds of up to 75 mph (120 km/h).

Opening/closing the sunroof

- ▶ To open the sunroof, use the part of the button located towards the rear.
- ▶ To close the sunroof, use the part of the button located towards the front.

Operating the button

- ▶ Pressing the button beyond its point of resistance opens or closes the sunroof fully.
- ▶ Pressing the button again stops the movement in progress.
- ▶ By keeping the button pressed (without going beyond the point of resistance), the movement of the glass stops when this button is released.
- ▶ When the sunroof is closed: pressing once without passing the point of resistance moves it to the partially open position.
- ▶ When the sunroof is partially open: pressing once on the front part of the button, without going beyond the point of resistance, closes it completely.

i The sunroof and windows can be closed by holding down the door locking control. The manoeuvre stops as soon as the locking control is released.

Opening/closing the blind

- ▶ To open the blind, pull its handle backwards until the desired position is reached.
- ▶ To close the blind, push its handle forwards until the desired position is reached.

Reinitialisation

Reinitialisation is required after reconnecting the battery, or if the sunroof malfunctions or moves in a jerky manner.

▶ Check that nothing is affecting the movement of the sunroof and that the seals are clean.

 ▶ With the ignition on, fully close the sunroof.

▶ Press and hold the front part of the button until the sunroof moves slightly, hold for a further 1 second, then release.

▶ Wait 2 seconds then press and hold the front part of the button again. The sunroof will open and close again. Once the roof is fully closed again, hold for a further 2 seconds, then release.

PEUGEOT i-Cockpit

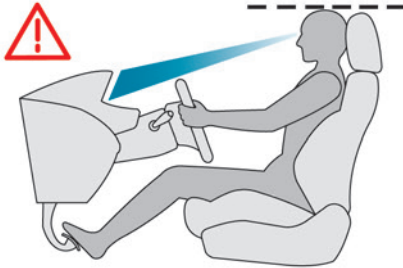

Before taking to the road and to make the most of the ergonomic layout of the PEUGEOT i-Cockpit, carry out these adjustments in the following order:

- head restraint height.
- seat backrest angle.
- seat cushion height.
- longitudinal seat position.
- steering wheel reach and then height.
- rear view mirror and door mirrors.

Once these adjustments have been made, check that the "head-up" instrument panel can be viewed correctly over the smaller diameter steering wheel.

! Before moving the seat backwards, ensure that there is no person or object that might prevent the full travel of the seat. There is a risk of trapping or pinching passengers if present in the rear seats or of jamming the seat if large objects are placed on the floor behind the seat.

Front seats

Front head restraints

Adjusting the height

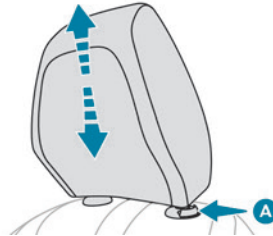

Upwards:

► Pull the head restraint up to the desired position; you can feel the head restraint clicking into position.

Downwards:

► Press lug **A** to lower the head restraint.

i The head restraint is correctly adjusted when its upper edge is level with the top of the occupant's head.

Removing a head restraint

- Pull the head restraint fully up.
- Press lug **A** to release the head restraint and raise it fully.
- Stow the head restraint securely.

Refitting a head restraint

- Insert the head restraint rods into the guides in the corresponding seat backrest.
- Push the head restraint fully down.
- Press the lug **A** to release the head restraint and push it down.
- Adjust the height of the head restraint.

! Never drive with the head restraints removed; they should be in place and adjusted for the occupant of the seat.

Manually-adjustable seats

Longitudinal

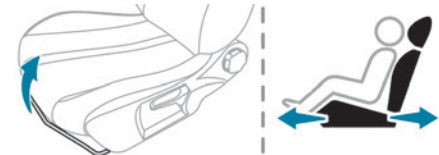

- ▶ Raise the control bar and slide the seat forwards or backwards.
- ▶ Release the control bar to lock the seat in position on one of the notches.

Backrest angle

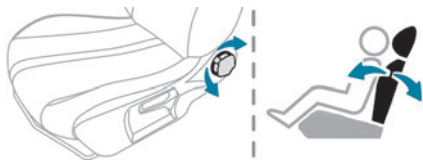

- ▶ Turn the knob to obtain the desired angle.

Height

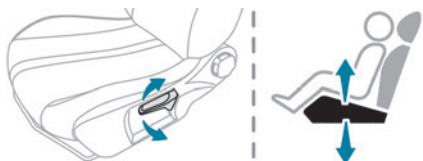

- ▶ Pull the control upwards to raise or push it downwards to lower, until you obtain the position required.

Electrically-adjustable seats

Longitudinal

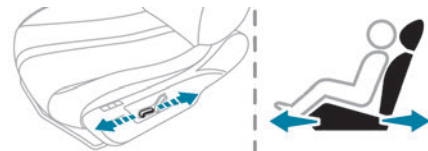

- ▶ Push the control forwards or backwards to slide the seat.

Backrest angle

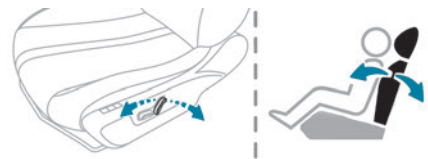

- ▶ Tilt the control forwards or rearwards.

Cushion height and angle

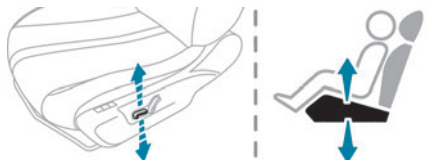

- ▶ Tilt the rear of the control upwards or downwards to obtain the required height and angle.

Electric lumbar adjustment

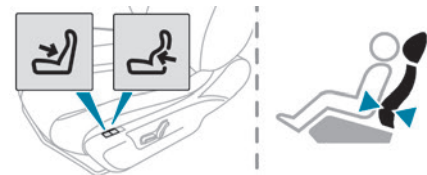

- ▶ Press the + or - control to obtain the desired lumbar support.

Massage function

(Driver's seat only)

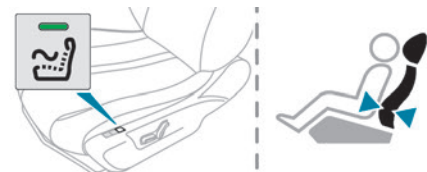

This function provides lumbar massage; it only operates when the engine is running as well as in STOP mode of the Stop & Start system.

Activation/Deactivation

- ▶ Press this button to activate/deactivate the function.

Upon activation, the indicator lamp comes on. The massage function is activated for a period of one hour.

During this time, massage is performed in 6 cycles of 10 minutes (6 minutes of massage followed by a 4-minute break).

After one hour, the function is deactivated; the indicator lamp goes off.

Heated seats



The function is active only with the engine running and when the outside temperature is below 20°C.

- ▶ Press the button corresponding to the seat.
 - ▶ Each press changes the heating level; the corresponding number of indicator lamps come on.
 - ▶ To switch off the heating, press the button until all of the indicator lamps are off.
- The system status is memorised when the ignition is switched off.



Do not use the function when the seat is not occupied.

Reduce the heating intensity as soon as possible.

When the seat and passenger compartment have reached a satisfactory temperature, switch the function off; reducing electrical

consumption in turn decreases energy consumption.



Prolonged use of heated seats is not recommended for people with sensitive skin.

There is a risk of burns for people whose perception of heat is impaired (e.g. illness, taking medication).

To keep the heated pad intact and to prevent a short circuit:

- Do not place heavy or sharp objects on the seat.
- Do not kneel or stand on the seat.
- Do not spill liquids onto the seat.
- Never use the heating function if the seat is damp.

Steering wheel adjustment



- ▶ When stationary, pull the control to release the steering wheel.

- ▶ Adjust the height and reach to suit your driving position.
- ▶ Push the control to lock the steering wheel.



For safety reasons, these adjustments must only be carried out with the vehicle stationary.

Mirrors

Door mirrors



As a safety measure, the mirrors should be adjusted to reduce the "blind spots". The objects that you see in the mirrors are in fact closer than they appear. Take this into account in order to correctly judge the distance of vehicles approaching from behind.

Adjustment

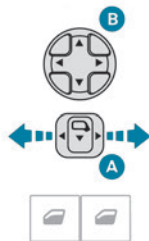

- ▶ Move control **A** to the right or to the left to select the corresponding mirror.
- ▶ Move control **B** in any of the four directions to adjust.
- ▶ Return control **A** to its central position.

Manual folding

The mirrors can be folded manually (parking obstruction, narrow garage, etc.).

- ▶ Turn the mirror towards the vehicle.

Electric folding

Depending on equipment, the door mirrors can be folded electrically.



- ▶ From the inside, with the ignition on, place control **A** in the central position.
- ▶ Pull control **A** backwards.

- ▶ Lock the vehicle from the outside.

i If the mirrors are folded using control **A**, they will not unfold when the vehicle is unlocked.

Electric unfolding

- ▶ From outside: unlock the vehicle.
- ▶ From inside: with the ignition on, place control **A** in the central position and then pull it rearwards.

i With Touch screen 10" & Bluetooth Radio & Telephone

 The automatic door mirror folding/unfolding function is configured in the **Driving** touch screen menu.

With PEUGEOT i-Connect Advanced

 The automatic door mirror folding/unfolding function is configured in the **Settings > Vehicle** touch screen application.

Demisting/Defrosting

 The demisting/defrosting of the door mirrors works with the demisting/defrosting of the rear screen.

For more information on **Rear screen demisting/defrosting**, refer to the corresponding section.

Interior rear view mirror

Equipped with an anti-dazzle system, which darkens the mirror glass and reduces the nuisance to the driver caused by the sun, headlights of other vehicles, etc.

Manual model

Day/night position

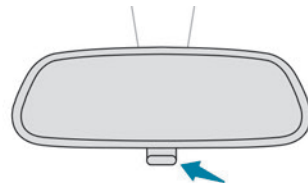

- ▶ Pull the lever to change to the anti-dazzle "night" position.
- ▶ Push the lever to change to the normal "day" position.

Adjustment

- ▶ Adjust the mirror to the normal "day" position.

Automatic "electrochrome" models

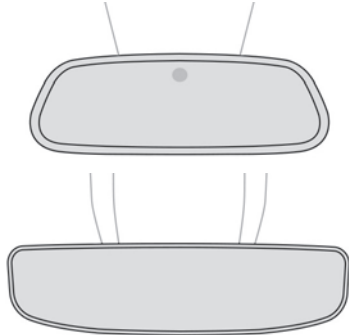

The electrochrome system uses a sensor that detects the level of exterior brightness and that coming from the rear of the vehicle, in order to automatically and gradually switch between day and night usage.

To ensure optimum visibility while manoeuvring, the mirror automatically brightens when reverse gear is engaged. The system is deactivated if the load in the boot exceeds the height of the load space cover or if the load space cover has items placed on it.

Rear bench seat

Bench seat with fixed cushions and split folding backrests (2/3-1/3) to adapt the boot load space.

The rear seat cushion remains fixed. To increase the boot loading volume, tilt the bench seat backrest.

Rear head restraints

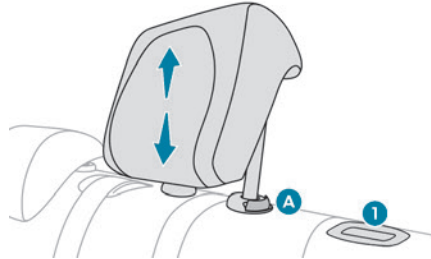

They have two positions:

- A **high position**, for when the seat is in use:
 - ▶ Pull the head restraint fully up.
- A **low position**, for stowing, when the seat is not in use:

- ▶ Press the lug **A** to release the head restraint and push it down.

The rear head restraints can be removed.

Removing a head restraint

- ▶ Release the backrest using control **1**.
- ▶ Tilt the backrest slightly forwards.
- ▶ Pull the head restraint fully up.
- ▶ Press the lug **A** to release the head restraint and remove it completely.

Refitting a head restraint

- ▶ Insert the head restraint rods into the guides in the corresponding backrest.
- ▶ Push the head restraint fully down.
- ▶ Press the lug **A** to release the head restraint and push it down.

Never drive with passengers seated at the rear when the head restraints are removed; the head restraints should be in place and in the high position. The head restraint for the centre seat and those for the outer seats are not interchangeable.

Folding the backrests

Manoeuvring the backrests should only be done when the vehicle is stationary.

First steps:

- ▶ Lower the head restraints.
- ▶ If necessary, move the front seats forward.
- ▶ Check that no person or object might interfere with the folding of the backrests (e.g. clothing, luggage).
- ▶ Check that the seat belts are free, not engaged in the buckles. Release them so that the backrest can be moved.



- ▶ Press the backrest release grip 1.
- ▶ Guide the backrest 2 down to the horizontal position.

i When the backrest is released, the red indicator in the release grip is visible.

Repositioning the backrests

! First check that the outer seat belts are lying vertically flat alongside the backrest latching rings.

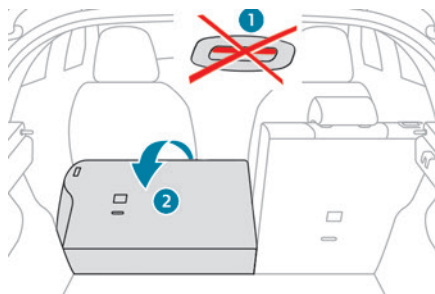

- ▶ Put the backrest 2 in the upright position and push it firmly to latch it home.
- ▶ Check that the red indicator is no longer visible in the release grip 1.
- ▶ Ensure that the outer seat belts were not trapped during the operation.

! Please note: an incorrectly latched backrest compromises the safety of passengers in the event of sudden braking or an accident.
The contents of the boot may be thrown forwards - risk of serious injury!

Heating and Ventilation

Air intake

The air circulating in the passenger compartment is filtered and originates either from the exterior, via the grille located at the base of the windscreen, or from the inside in air recirculation mode.

Controls



The controls are accessible in the touch screen and on the centre console panel.

Air distribution

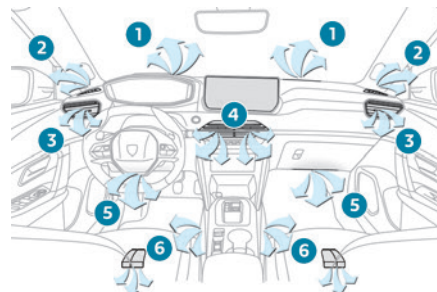

1. Windscreens demisting/de-icing vents
2. Front side window demisting/de-icing vents
3. Adjustable and closable side air vents
4. Adjustable and closable central air vents
5. Air outlets to the front footwells
6. Air outlets to the rear footwells (depending on version)

Advice

i Using the ventilation and air conditioning system

- ▶ To ensure that air is distributed evenly, keep the external air intake grilles at the base of the windscreen, the nozzles, the vents, the air outlets and the air extractor in the boot free from obstructions.

- ▶ Do not cover the sunshine sensor located on the dashboard; this sensor is used to regulate the automatic air conditioning system.
- ▶ Operate the air conditioning system for at least 5 to 10 minutes once or twice a month to keep it in good working order.
- ▶ If the system does not produce cold air, switch it off and contact a PEUGEOT dealer or a qualified workshop.

When towing a large load on a steep gradient in high temperatures, switching off the air conditioning increases the available engine power, enhancing the towing capacity.

! Avoid driving for too long with the ventilation off or with prolonged operation of interior air recirculation. Risk of misting and deterioration of the air quality!

🌿 If the interior temperature is very high after the vehicle has stood for a long time in the sunshine, air the passenger compartment for a few moments. Put the air flow control at a setting high enough to quickly change the air in the passenger compartment.

i Condensation created by the air conditioning results in a discharge of water underneath the vehicle. This is perfectly normal.

i Servicing the ventilation and air conditioning system

- ▶ Ensure that the passenger compartment filter is in good condition and have the filter elements replaced regularly. We recommend using a composite passenger compartment filter. Its specific active additive helps protect against polluting gases and bad smells.
- ▶ To ensure correct operation of the air conditioning system, have it checked according to the recommendations in the Manufacturer's service schedule.

i Stop & Start

The heating and air conditioning systems only operate when the engine is running. Temporarily deactivate the Stop & Start system to maintain a comfortable temperature in the passenger compartment. For more information on the **Stop & Start** system, refer to the corresponding section.

i ECO driving mode

Selecting this mode reduces electrical energy consumption, but restricts the performance of the heating and air conditioning systems, although it does not deactivate them.

Automatic air conditioning

This system automatically controls the activation of the air conditioning system, regulating the temperature, air flow and air distribution inside the passenger compartment.

This system works with the engine running, but access to the ventilation and its controls remains possible with the ignition on.



Press the **Climate** application button to display the system controls page.

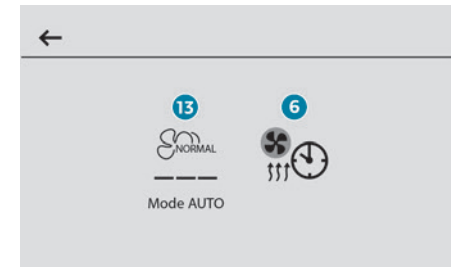
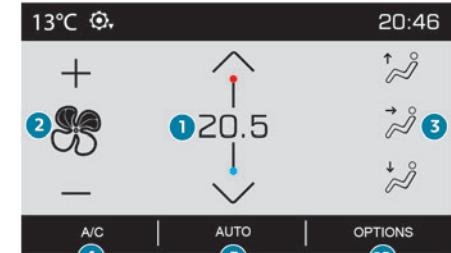

With Touch screen 10" & Bluetooth Radio & Telephone



With PEUGEOT i-Connect Advanced - PEUGEOT i-Connect

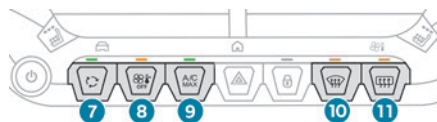

1. Temperature adjustment
2. Air flow adjustment
3. Air distribution adjustment
4. Air conditioning on/off
5. Automatic air conditioning on/off and setting (AUTO SOFT/AUTO NORMAL/AUTO FAST)
6. Temperature pre-conditioning (depending on version)
7. Interior air recirculation
8. Switching the system off
9. Maximum air conditioning
10. Front demisting/defrosting
11. Rear screen demisting/defrosting
12. Access to the secondary page

13. Selection of settings for the Automatic air conditioning (AUTO SOFT/AUTO NORMAL/AUTO FAST)

Temperature adjustment

The driver and front passenger can each choose their own temperature setting.

The value indicated corresponds to a level of comfort and not to a precise temperature.

► Press one of the buttons **1** (+ or -) or drag vertically to increase or decrease the value.

It is possible to go beyond the minimum and maximum values by selecting respectively **Low** or **High**.

It is recommended that you avoid a difference of more than 3°C in the settings for left and right.

Automatic air conditioning

This automatic mode ensures optimum management of the passenger compartment temperature, air flow and air distribution, based on the selected comfort level.

► Press button **5-AUTO** to activate/deactivate the automatic mode of the air conditioning system.

The indicator lamp in the button lights up when the air conditioning system is operating automatically.

The intensity of the automatic air conditioning is modulated by choosing one of the following settings:

- **AUTO SOFT**: provides soft and quiet operation by limiting air flow.
- **AUTO NORMAL**: offers the best compromise between a comfortable temperature and quiet operation (default setting).
- **AUTO FAST**: provides dynamic and efficient air distribution.

With Audio System with Touch Screen

To change the current setting (shown by the corresponding indicator lamp), press button **13** repeatedly until the desired setting is displayed.

To ensure passenger comfort in the rear seats, favour **"Normal"** and **"Fast"** settings.

This setting is associated with automatic mode only. However, on deactivation of **AUTO** mode, the indicator lamp for the most recently selected setting remains on.

Changing the setting does not reactivate **AUTO** mode if it was deactivated.

With PEUGEOT i-Connect Advanced - PEUGEOT i-Connect

To change the AUTO mode, press button **5-AUTO** successively.

To ensure passenger comfort in the rear seats, favour settings **AUTO NORMAL** and **AUTO FAST**.

i In cold weather with the engine cold, the air flow is increased gradually until the comfort setting has been reached, in order to

limit the delivery of cold air into the passenger compartment.

On entering the vehicle, if the interior temperature is much colder or warmer than the comfort setting requested, there is no need to alter the value displayed to more quickly reach the required level of comfort. The system automatically corrects the temperature difference as quickly as possible.

Automatic air conditioning manual settings

It is possible to manually adjust one or more of these functions, while the system retains automatic control of the other functions:

- air flow.
- air distribution.

The indicator lamp in the "AUTO" button goes out if a setting is changed.

► Press button **5-AUTO** again to reactivate automatic air conditioning.

Adjusting the air flow

► Press one of the buttons **2 (fan)** or drag horizontally to increase or decrease air flow. It is also possible to directly press one of the values.

i Switching off the air conditioning system

When the air flow is reduced to a minimum, ventilation stops.

"OFF" is displayed alongside the fan.

Adjusting the air distribution

► Press the buttons **3** to adjust the air flow distribution inside the passenger compartment.

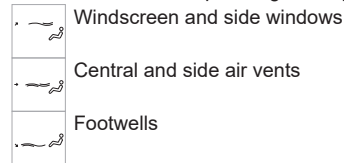

A symbol is activated to display the presence of blown air in the direction indicated.

It is possible to activate all three buttons simultaneously, for uniform distribution throughout the passenger compartment.

Air conditioning on/off

The air conditioning system is designed to operate effectively in all seasons, with the windows closed:

- It lowers the temperature in summer.
- It increase the effectiveness of the demisting, in winter, above 3°C.

► Press button **4-A/C** to switch the air conditioning on/off.

When the function is switched on, "A/C" changes colour.

i Air conditioning does not operate when the air flow is deactivated.

To obtain cool air more quickly, enable interior air recirculation for a brief period. Then return to the intake of exterior air.

Switching off the air conditioning may result in some discomfort (humidity or misting).

Maximum air conditioning

This function automatically adjusts the temperature setting to the lowest possible, the air distribution towards the central and side air vents, the air flow to maximum and, if necessary, activates interior air recirculation.

► Press this button to activate/deactivate the function (confirmed by the illumination/extinction of the indicator lamp). Once the function is deactivated, the system returns to the previous settings.

Switching off the air conditioning system

► Press button **8-OFF**.

Its indicator lamp lights up and all the other indicator lamps of the air conditioning system go off.

This action deactivates all of the functions of the air conditioning system.

The temperature is no longer regulated. A slight flow of air can still be felt, due to the forward movement of the vehicle.

Interior air recirculation

The intake of exterior air prevents the formation of mist on the windscreen and side windows. Recirculating the interior air isolates the passenger compartment from outside odours and fumes and allows the desired passenger compartment temperature to be achieved more rapidly.



► Press this button to activate/deactivate the function (confirmed by the illumination/extinction of the indicator lamp).



This function is activated automatically when reverse gear is engaged.

Maximum air conditioning

This function automatically adjusts the temperature setting to the lowest possible, the air distribution towards the central and side air vents, the air flow to maximum and, if necessary, activates interior air recirculation.



► Press this button to activate/deactivate the function (confirmed by the illumination/extinction of the indicator lamp). Once the function is deactivated, the system returns to the previous settings.

Switching off the thermal comfort system



► Press this button.

Its indicator lamp comes on and all of the other indicator lamps for the system go off. This action deactivates all of the functions of the air conditioning system.

The temperature is no longer regulated. A slight flow of air can still be felt, due to the forward movement of the vehicle.

Front demisting/defrosting

Automatic Visibility programme

This mode allows the windscreen and side windows to be demisted or defrosted as quickly as possible.



► Press this button to activate/deactivate the mode (confirmed by the illumination/extinction of the indicator lamp).

The programme automatically manages the air conditioning (depending on version), air flow and air intake, and provides optimum distribution towards the windscreen and side windows. It is possible to manually change the air flow without deactivating the automatic Visibility programme.



With Stop & Start, when demisting has been activated, STOP mode is not available.



In wintry conditions, before moving off, it is essential to remove any snow or ice from the windscreen around the camera. Otherwise, the operation of the equipment using the camera may be affected.

Rear screen demisting/defrosting

This demisting/de-icing only works with the engine running. Depending on version, it also demists/de-ices the door mirrors.



► Press this button to activate/deactivate the function (confirmed by the indicator lamp coming on/switching off).

Demisting/defrosting switches off automatically to prevent an excessive consumption of electrical current.



Switch off demisting/defrosting when you no longer need it; reducing electrical consumption in turn decreases energy consumption.

Temperature pre-conditioning (Electric)

This function allows you to programme the temperature in the passenger compartment to reach a pre-defined, non-modifiable temperature (approx. 21°C) before you enter the vehicle, on the days and at the times of your choice. This function is available when the vehicle is connected or not connected.

Programming

With Touch screen 10" & Bluetooth Radio & Telephone

In the **Climate > OPTIONS** menu:



Select **Temperature conditioning**.

- ▶ Press **+** to add a programme.
- ▶ Select the time of entry into the vehicle and the desired days. Press **OK**.
- ▶ Press **ON** to activate this programme.

With PEUGEOT i-Connect Advanced - PEUGEOT i-Connect



In the **Climate** touch screen application, select the **Preconditioning** tab.

- ▶ Press **+** to add a programme.
- ▶ Select the time of entry into the vehicle and the desired days. Press **OK**.
- ▶ Press **ON** to activate this programme.

The temperature pre-conditioning sequence begins approximately 45 minutes before the

programmed time when the vehicle is connected (20 minutes when it is not connected) and is maintained for 10 minutes after.

i You can set multiple programmes. Each one is saved in the system.

To optimise the driving range, we recommend starting a programme while the vehicle is connected.



Programming can also be carried out from a smartphone using the **MYPEUGEOT APP** application.

For more information on **Remotely operable additional functions**, refer to the corresponding section.

i The fan noise that occurs during temperature pre-conditioning is perfectly normal.

Operating conditions

- The function is only activated when the **ignition is switched off** and the **vehicle locked**.
- When the vehicle is not connected, the function is only activated if the battery charge level is greater than 30%.
- When the vehicle is not connected and a recurring programme is active (e.g. from Monday to Friday), if two temperature pre-conditioning sequences are run without the vehicle being used, the programme will be deactivated.

Interior fittings

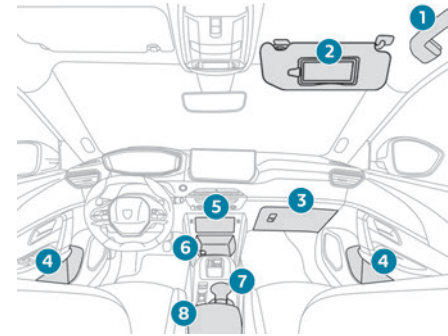

1. Grab handle
2. Sun visor
3. Glove box
4. Door pockets
5. Storage compartment or Storage compartment with flap or Wireless smartphone charger with flap (depending on version)
 - ▶ Press the top centre of the flap to open it.
6. Storage compartment with 12 V accessory socket
7. Cup holder
8. Adjustable centre armrest with storage compartment
 - Rear USB socket(s) (depending on version)

! Make sure you do not leave any item in the passenger compartment which could

act like a magnifying glass under the effect of the sun's rays and cause a fire - risk of fire or damage to interior surfaces!

Sun visor

► With the ignition on, raise the concealing flap; depending on the version, the mirror is illuminated automatically. This sun visor is also equipped with a ticket holder.

Glove box

► To open the glove box, lift the handle.

! Never drive with the glove box open when a passenger is at the front. It may cause injury during sharp deceleration!

USB sockets

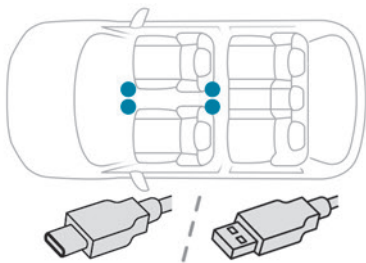

Depending on equipment, the vehicle is fitted with USB-A and/or USB-C sockets.



The USB socket at the front on the right-hand side also allows a smartphone to be connected by Android Auto® or CarPlay®, enabling certain smartphone applications to be used on the touch screen. For best results, use a cable made or approved by the device manufacturer. These applications can be managed using the steering-mounted controls or the audio system controls.

i When the USB socket is used, the portable device charges automatically. While charging, a message is displayed if the power drawn by the portable device exceeds the current supplied by the vehicle. For more information about how to use this equipment, refer to the sections describing the audio and telematics systems.

12 V accessory socket

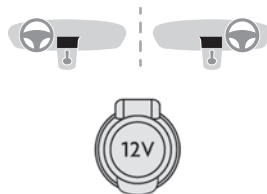

► Plug in a 12 V accessory (with a maximum rated power of 120 W) using a suitable adapter.

! Observe the maximum power rating to avoid damaging the accessory.

! The connection of an electrical device not approved by PEUGEOT, such as a USB charger, may adversely affect the operation of vehicle electrical systems, causing faults such as poor radio reception or interference with displays in the screens.

Wireless smartphone charger

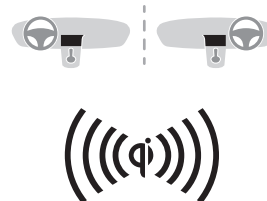

This system allows wireless charging of a portable device such as a smartphone, using the magnetic induction principle, in accordance with the Qi.

The portable device to be charged must be compatible with the Qi standard, either by design or by using a compatible holder or shell. A mat can also be used provided that it is approved by the Manufacturer. The charging area is identified by the Qi symbol.

The charger works with the engine running and with the Stop & Start system in STOP mode. Charging is managed by the smartphone. With the Keyless Entry and Start system, the charger's operation may be briefly disrupted when a door is opened or the ignition is switched off.

Charging

- ▶ Open the flap to access the charging area.
- ▶ With the charging area clear, place a device in its centre.



When the portable device is detected, the charger's indicator lamp lights up green. It remains lit for the whole time that the battery is being charged.

! The system is not designed to charge multiple devices simultaneously.

! Do not leave metal objects (e.g. coins, keys, vehicle remote control) in the charging area while a device is being charged - Risk of overheating or interrupting the charging!



! When using applications for a long time in combination with wireless charging,

some smartphones may switch to thermal safety and cause some functions to stop.

Checking operation

The state of the indicator lamp allows the operation of the charger to be monitored.

State of the indicator lamp	Meaning
Off	Engine switched off. No compatible devices detected. Charging complete.
Fixed green	Compatible portable device detected. Charging.
Flashing orange	Foreign object detected in the charging zone. Portable device not well centred in the charging zone.
Fixed orange	Malfunction of the portable device's battery meter. Device battery temperature too high. Charger malfunction.



If the indicator lamp is fixed orange:

– remove the device, then place it back in the centre of the charging zone.

or

– remove the device and try again in a quarter of an hour.

If the problem persists, have the system checked by a PEUGEOT dealer or a qualified workshop.

Mats

Fitting

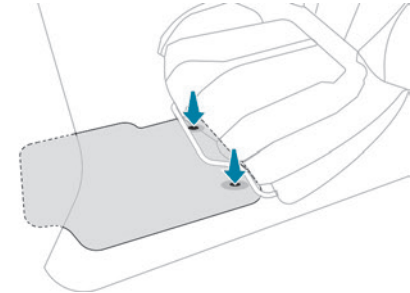

When fitting it on the driver's side, only use the mountings present on the carpet (a "click" indicates proper locking). The other mats are simply laid over the carpet.

Removing/refitting

- ▶ To remove it on the driver's side, move the seat backwards and unclip the fasteners.
- ▶ To refit it, position the mat and secure it by pressing down.

- ▶ Check that the mat is secured correctly.

! To avoid any risk of jamming the pedals:

- Only use mats which are suited to the fixings already present in the vehicle; these fixings must be used.
- Never fit one mat on top of another.

The use of mats not approved by PEUGEOT may interfere with access to the pedals and hinder the operation of the cruise control/speed limiter.

The approved mats have two fasteners located underneath the seat.

Courtesy lamps

Non touch-sensitive version

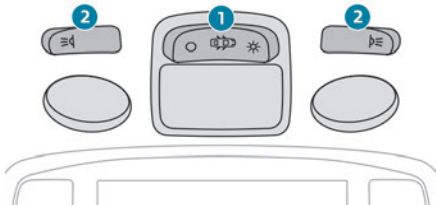

1. Front courtesy lamp
2. Front reading lamps

Front courtesy lamp



In this position, the courtesy lamp comes on gradually:

- when the vehicle is unlocked.
 - when the key is removed from the ignition switch.
 - when a door is opened.
 - when the remote control locking button is activated, in order to locate the vehicle.
- It switches off gradually:
- when the vehicle is locked.
 - when the ignition is switched on.
 - 30 seconds after the last door is closed.



Permanently off.



Permanent lighting.

In "Permanent lighting" mode, the lighting time varies according to the circumstances:

- With the ignition off, approximately 10 minutes.
- In energy saving mode, approximately 30 seconds.
- With the engine running, unlimited.

Reading lamps



- ▶ With the ignition on, operate the corresponding switch.

! Do not place anything against the courtesy lamps.

Touch version with LED

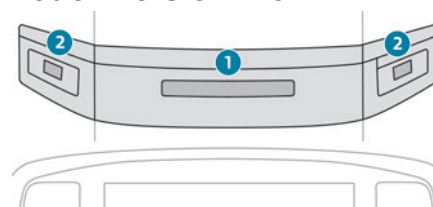

1. Front touch-sensitive courtesy lamp
2. Front touch-sensitive reading lamps

Touch-sensitive courtesy lamp

It comes on:

- when the vehicle is unlocked.
- when the ignition is switched off.
- when a door is opened.
- when the remote control locking button is activated, in order to locate the vehicle.

It switches off:

- when the vehicle is locked.
- when the ignition is switched on.
- 30 seconds after the last door is closed.

The front and rear touch-sensitive reading lamps come on and go off at the same time as the courtesy lamp.

i A long press on the front touch-sensitive courtesy lamp completely deactivates it (confirmed by the "OFF" symbol). The front and rear touch-sensitive reading lamps still remain operational.

Touch-sensitive reading lamps

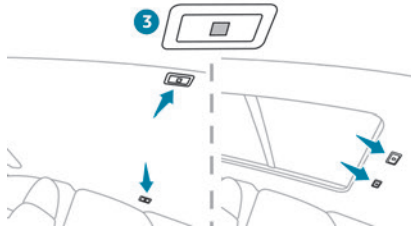

3. Rear touch-sensitive reading lamps

► With the ignition on, press the corresponding reading lamp.

Interior ambient lighting

Soft passenger compartment lighting improves visibility inside the vehicle in low-light conditions.

With Touch screen 10" & Bluetooth Radio & Telephone



Activation/deactivation and adjustment of the brightness are set via the **Driving** touch screen menu.

With PEUGEOT i-Connect Advanced - PEUGEOT i-Connect

By default, the colour of the interior ambient lighting is linked to that of the screens, depending on the driving mode selected.



Activation/deactivation and adjustment of the brightness are set via the **Settings > Brightness** touch screen application. The colour is selected via the **Settings > Customization** touch screen application.

Boot fittings

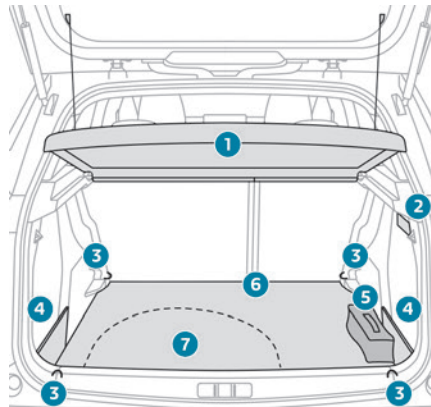

1. Load space cover
2. Boot lamp
3. Stowing rings
4. Open storage wells
5. Tool kit (depending on equipment)
6. Boot carpet or 2-position boot floor
7. Storage well



The stowing rings are designed to secure luggage using different types of retaining nets. These retaining nets are available as an accessory. For more information, contact a PEUGEOT dealer or a qualified workshop.

2-position boot floor

This two-position floor allows the boot volume to be optimised using the lateral stops located on the sides:

- High position (**100 kg max.**): to obtain a flat floor up to the front seats, when the rear seats are folded down.
- Low position (**150 kg max.**): maximum boot volume.



On certain versions, the adjustable boot floor cannot be fitted in the low position.

To change the height:

- Lift and pull the floor towards you using its central handle, then use the lateral stops to move it.
- Push the floor all the way forwards to place it in the desired position.

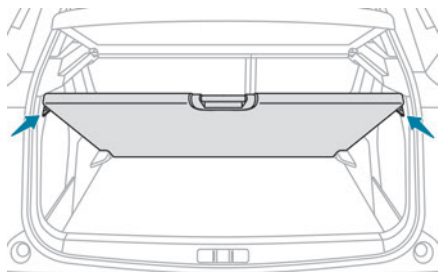

- In energy saving mode, approximately 30 seconds.
- With the engine running, unlimited.

To keep it in the inclined position:

- ▶ From the high position, lift the floor towards the load space cover.
- ▶ Take it past the retractable stops, then rest the floor on these stops.

Storage well

- ▶ Lift the boot carpet as far as possible to access the storage well.

Depending on version, it includes:

- A temporary puncture repair kit with the tool kit.
- A spare wheel with the tool kit.

Boot lamp

It comes on automatically when the boot is opened and goes off automatically when the boot is closed.

The lighting time varies according to the circumstances:

- When the ignition is off, approximately 10 minutes.

Exterior lighting control stalk

Main lighting

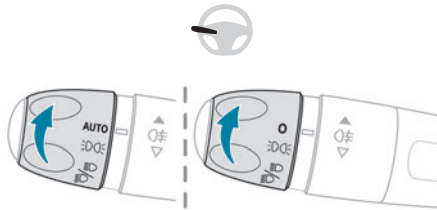

AUTO Automatic illumination of lamps/daytime running lamps

or

0 Lamps off (ignition off)/
Daytime running lamps (engine running)
Sidelamps only

 Dipped or main beam headlamps

i "Highway function"
(Depending on country of sale)

With "Full LED" technology headlamps, the range of the dipped beam headlamps is automatically increased once the speed of the vehicle is above 68 mph (110 km/h).

Headlamp dipping

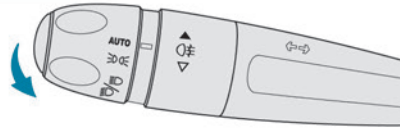

► Pull the lighting control stalk to switch between dipped and main beam headlamps. In lamps off or "AUTO" modes, depending on version, and in sidelamps mode, pull the lighting control stalk to switch the main beam headlamps on directly ("headlamp flash").

Display

Illumination of the corresponding indicator lamp on the instrument panel confirms that the selected lighting is on.



A fault with a lamp is signalled by the permanent illumination of this warning lamp, accompanied by the display of a message and an audible signal.

Rear foglamp



It only works if the dipped or main beam headlamps are on.

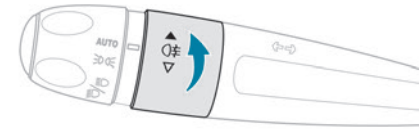

► Rotate the ring forwards/backwards to turn it on/off.

When the lighting is switched off automatically ("AUTO" position) the foglamp and the sidelamps remain on.

! Switching on the foglamps is prohibited in clear weather or in rain, both day and night. In these situations, the power of their beams may dazzle other drivers. They must only be used in fog or falling snow (rules may vary depending on country).

Do not forget to switch off the foglamps when they are no longer necessary.

i **Switching off of the lighting when the ignition is switched off**

When the ignition is switched off, all of the lamps turn off immediately, except for the dipped beam headlamps if automatic guide-me-home lighting is activated.

i **Switching on the lamps after switching off the ignition**

To reactivate the lighting control, rotate the ring, depending on version, to the "0" position - lamps off, or to the "AUTO" position, then to the desired position.

If the driver's door is opened, a temporary audible signal warns the driver that the lamps are on.

They will go off automatically after a period of time that depends on the level of charge in the battery (entering energy economy mode).

i In some weather conditions (e.g. low temperature or humidity), misting on the internal surface of the glass of the headlamps and rear lamps is normal, and will disappear after the lamps have been on for a few minutes.

! Never look too closely at the light beam of LED technology lamps - risk of serious eye injury!



i Travelling abroad

Vehicles equipped with manual headlamp beam height adjustment: If planning to use your vehicle in a country that drives on the other side of the road, the dipped beam headlamps must be adjusted to

avoid dazzling oncoming drivers. Consult a PEUGEOT dealer or a qualified workshop.

Daytime running lamps/ Sidelamps

These LED lamps at the front and rear of the vehicle light up automatically when the engine starts.

They perform the following functions:

- Daytime running lamps (lighting control stalk at position "0" or "AUTO" with adequate ambient light).
- Sidelamps (lighting control stalk at position "AUTO" with low ambient light or "Sidelamps only" or "Dipped/main beam headlamps").

Direction indicators

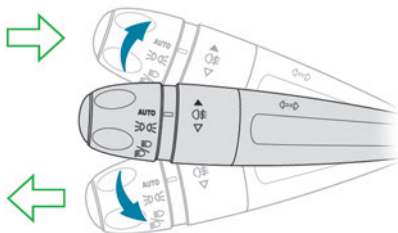

▶ Left or right: lower or raise the lighting control stalk, beyond the point of resistance.

i If you keep the direction indicators on for more than 20 seconds, the volume of the

audible signal will increase if the speed is above 50 mph (80 km/h).

Three flashes

▶ Press briefly upwards or downwards, without going beyond the point of resistance; the direction indicators will flash 3 times.

Parking lamps

(Depending on version)

Vehicle side marking by lighting the sidelamps on the traffic side only.

▶ Within one minute after switching off the ignition, operate the lighting control stalk upwards or downwards, depending on the side of the traffic (e.g. when parking on the right, push the lighting control stalk down to light up on the left).

This is confirmed by an audible signal and the lighting of the corresponding direction indicator lamp on the instrument panel.

▶ To switch off the parking lamps, return the lighting control stalk to the central position.

Headlamp beam height adjustment

Manual headlamp adjustment

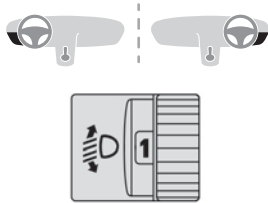

To avoid dazzling other road users, the height of the headlamp beams must be adjusted according to the load in the vehicle.

0 (Initial setting)

Driver only or driver + front passenger

1 5 people

2 5 people + load in the boot

3 Driver only + load in the boot

4 5 6 Not used

This information is provided as a guide only. Depending on version, the unused positions may be required.

Automatic adjustment of the Full LED technology headlamps

This system automatically adjusts the height of the headlamp beams according to different parameters (e.g. vehicle load).



In the event of a malfunction, this warning lamp lights up on the instrument panel, accompanied by the display of a message and an audible signal.

The system places the headlamp beams in the lowest position.

Have it checked by a PEUGEOT dealer or a qualified workshop.



Do not touch the LED or Full LED technology headlamps - risk of electrocution!

Automatic illumination of lamps

With the lighting control stalk in the "AUTO" position and if a low level of exterior brightness is detected by the rain/sunshine sensor, the number plate lamps, sidelamps and dipped beam headlamps are switched on automatically, without any action on the part of the driver. They may also come on if rain is detected, at the same time as automatic operation of the windscreen wipers.

As soon as the brightness returns to a sufficient level or after the windscreen wipers are switched off, the lamps are switched off automatically.

Malfunction



In the event of a malfunction of the rain/sunshine sensor, the vehicle's lamps come on and this warning lamp is displayed on the instrument panel, accompanied by an audible signal and/or the display of a message. Have it checked by a PEUGEOT dealer or a qualified workshop.



Do not cover the rain/sunshine sensor located at the top centre of the windscreen behind the interior rear view mirror; the associated functions would no longer be controlled.



In fog or snow, the rain/sunshine sensor may detect sufficient light. For this reason, the lighting will not come on automatically.



The inner surface of the windscreen may become misted up and affect the proper operation of the rain/sunshine sensor. In humid and cold weather, demist the windscreen regularly.

Guide-me-home and welcome lighting

Guide-me-home lighting

Automatic

With the ring of the lighting control stalk in the "AUTO" position and when the light is poor, the dipped beam headlamps come on automatically when the ignition is switched off.

With Touch screen 10" & Bluetooth Radio & Telephone



You can activate/deactivate this function and adjust the guide-me-home lighting duration in the **Driving** touch screen menu.

With PEUGEOT i-Connect Advanced - PEUGEOT i-Connect



You can activate/deactivate this function and adjust the duration of the guide-me-home lighting in the **Settings > Vehicle** touch screen application.

Manual

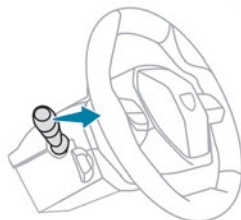

► With the ignition off, pull the lighting control stalk toward you ("headlamp flash") to activate/deactivate the function.

Manual guide-me-home lighting goes off automatically after a period of time.

Welcome lighting

When the vehicle is unlocked, if the ambient light is low and the "Automatic illumination of headlamps" function is activated, this system automatically turns on certain exterior lamps as well as certain lamps in the passenger compartment.

With Touch screen 10" & Bluetooth Radio & Telephone



You can activate/deactivate this function and adjust the welcome lighting duration in the **Driving** touch screen menu.

With PEUGEOT i-Connect Advanced - PEUGEOT i-Connect



You can activate/deactivate this function and adjust the duration of the welcome lighting in the **Settings > Vehicle** touch screen application.

Door mirror spotlamps

These spotlamps facilitate access to the vehicle by lighting the ground near the front doors.

The spotlamps come on automatically:

- when the vehicle is unlocked.
- when a door is opened.
- when a request to locate the vehicle is received from the remote control.

They also come on with the welcome lighting and guide-me-home lighting functions.

They go off automatically after 30 seconds.

Automatic lighting systems - General recommendations

The automatic lighting systems use a detection camera, located at the top of the windscreen.

i Operating limits

The system may be disrupted or not work correctly:

- When visibility conditions are poor (e.g. snowfall, heavy rain).

- If the windscreen is dirty, misted-up or masked (e.g. sticker) in front of the camera.
 - If the vehicle is facing highly reflective signs or safety barrier reflectors.
- The system is not able to detect:
- Road users that do not have their own lighting, such as pedestrians.
 - Vehicles with hidden lighting (e.g. travelling behind a safety barrier on the motorway).
 - Vehicles at the top or bottom of a steep slope, on winding roads, on crossroads.

! Maintenance

Clean the windscreen regularly, particularly the area in front of the camera. The internal surface of the windscreen can also become misted around the camera. In humid and cold weather, demist the windscreen regularly. Do not allow snow to accumulate on the bonnet or roof of the vehicle as this could obstruct the camera.

Automatic headlamp dipping

! For more information, refer to the **General recommendations for automatic lighting systems**.

Available only on versions equipped with Full LED technology headlamps.

With the ring of the lighting control stalk in the "AUTO" position and the function activated on the touch screen, this system automatically switches between dipped and main beam headlamps, according to lighting and traffic conditions, using a camera located at the top of the windscreen.

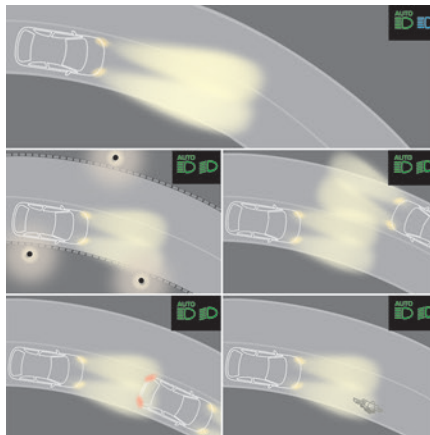

! This system is a driving aid. The driver remains responsible for the vehicle's lighting, its correct use in the prevailing light, visibility and traffic conditions, and for compliance with driving and vehicle regulations.

i The system becomes operational when the vehicle exceeds 16 mph (25 km/h). When the speed falls below 9 mph (15 km/h), the function is no longer operational.

Activation/Deactivation

With Touch screen 10" & Bluetooth Radio & Telephone

 The settings are changed via the **Driving** touch screen menu.

With PEUGEOT i-Connect Advanced - PEUGEOT i-Connect



 The settings are changed via the **Settings > Vehicle** touch screen application.

The state of the system is stored when the ignition is switched off.

i When the system detects thick fog, it temporarily deactivates the function.

Operation

If the ambient light level is very low and traffic conditions permit:

  – The main beam headlamps come on automatically. These indicator lamps light up on the instrument panel. If the ambient light level is sufficient and/or the traffic conditions do not allow the main beam headlamps to be lit:



– The dipped beam headlamps remain lit. These indicator lamps light up on the instrument panel.

The function is deactivated if the foglamps are switched on.

When the foglamps are switched off, the function is automatically reactivated.



This indicator lamp goes out when the function is deactivated.

Pause

If the situation requires a change of headlamp beam, the driver can take over at any time.

► Switch the headlamps manually between dipped and main beam to pause the function. If the "AUTO" and "Dipped beam" indicator lamps were on, the system changes to main beam.

If the "AUTO" and "Main beam" indicator lamps were on, the system changes to dipped beam.

► To reactivate the function, once again switch the headlamps manually between dipped and main beam.

Malfunction



If a malfunction occurs with the system or the camera, this warning lamp lights up on the instrument panel, accompanied by an audible signal and a message.

Have it checked by a PEUGEOT dealer or a qualified workshop.

Wiper control stalk

i Before operating the wipers in wintry conditions, clear any snow, ice or frost from the windscreen and around the wiper arms and blades.

! Do not operate the wipers on a dry windscreen. In extremely hot or cold weather, check that the wiper blades are not stuck to the windscreen before operating the wipers.

i After using an automatic car wash, you may temporarily notice abnormal noises and poorer wiping performance. You do not need to replace the wiper blades.

Without AUTO wiping

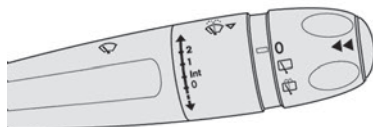

With AUTO wiping

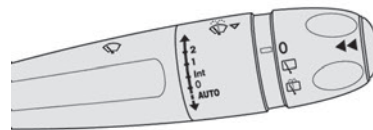

Windscreen wipers

► To select the wiping speed: raise or lower the stalk to the desired position.

- 2** Fast wiping (heavy rain)
- 1** Normal wiping (moderate rain)
- Int** Intermittent wiping (proportional to the vehicle's speed)
- 0** Switching off
- ↓** Single wipe (press down and release).

or

AUTO Automatic wiping

Refer to the corresponding section.

i If the ignition has been switched off with the windscreen wipers active, you must operate the control stalk again to reactivate wiping when the ignition is switched on again (unless the ignition was off for less than a minute).

a towing system, deactivate the automatic rear wiper via the touch screen.

Rear screenwash

► Turn the ring as far as it will go and hold it in position.

The screenwash and the wiper operate for as long as the ring remains turned.

A final wiping cycle is performed when screen washing ends.

Special position of the windscreen wipers

This maintenance position is used while cleaning or replacing the wiper blades. It can also be useful, in wintry weather (ice, snow), to release the wiper blades from the windscreen.

- To maintain the effectiveness of the flat wiper blades, it is advisable to:
 - handle them with care.
 - clean them regularly using soapy water.
 - avoid using them to hold cardboard on the windscreen.
 - replace them at the first signs of wear.

► In position 1 or 2, the wiping frequency is automatically reduced when the speed of the vehicle drops below 3 mph (5 km/h). When the speed is above 6 mph (10 km/h) again, the wiping frequency returns to the original frequency (fast or normal).

Single wipe

► Pull the stalk briefly towards you.

Windscreen wash

► Pull the wiper control stalk towards you and hold.

A final wiping cycle is performed when screenwashing ends.



► With automatic air conditioning, any action on the screenwash control results in temporary closure of the air intake to protect the passenger compartment from any odour.

! To avoid damaging the wiper blades, do not operate the screenwash if the screenwash reservoir is empty. Only operate the screenwash if there is no risk of the fluid freezing on the windscreen and hindering visibility. During the winter period, use "very cold climate" rated products. Never top up with water.

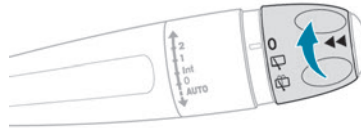
Rear wiper



► Turn the ring to align the desired symbol with the marking.

-  Off
-  Intermittent wiping
-  Screenwash-wipe

Reverse gear

When reverse gear is engaged, the rear wiper will come into operation automatically if the front windscreen wipers are operating.

With Touch screen 10" & Bluetooth Radio & Telephone



It is configured via the **Driving** touch screen menu.

With PEUGEOT i-Connect Advanced - PEUGEOT i-Connect



It is configured in the **Settings > Vehicle** touch screen application.



In the event of accumulation of snow or hard frost or if a bicycle carrier is fitted to

Before removing a windscreen wiper blade

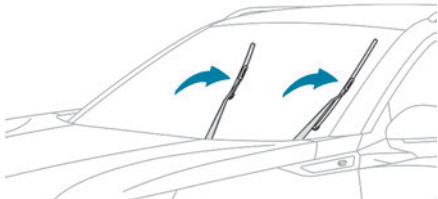

Operating the wiper control stalk immediately after switching off the ignition will place the wiper blades in a vertical position.

- ▶ Proceed with the desired operation or the replacement of the wiper blades.

After refitting a windscreen wiper blade

- ▶ To return the wiper blades to their initial position after the operation, switch on the ignition and operate the wiper control stalk.

Changing a wiper blade

Removing/Refitting at the front

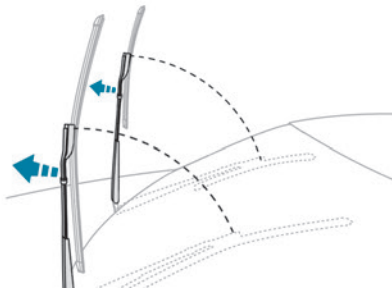

- ▶ Carry out these wiper blade replacement operations from the driver's side.
- ▶ Starting with the wiper blade farthest from you, hold each arm by the rigid section and raise it as far as possible.

! Do not touch the wiper blades - risk of irreparable deformation.
Do not release them while moving them. Risk of damaging the windscreen!

- ▶ Clean the windscreen using screenwash fluid.

i Do not apply "Rain X" type water-repellent products.

- ▶ Unclip the worn wiper blade closest to you and remove it.

- ▶ Install the new wiper blade and clip it to the arm.
- ▶ Repeat the procedure for the other wiper blade.
- ▶ Starting with the wiper blade closest to you, once again hold each arm by the rigid section, then guide it carefully onto the windscreen.

Removing/refitting at the rear

- ▶ Hold the arm by the rigid section and raise it as far as possible.
- ▶ Clean the rear screen using screenwash fluid.
- ▶ Unclip the worn wiper blade and remove it.
- ▶ Install the new wiper blade and clip it to the arm.
- ▶ Once again hold the arm by the rigid section, then guide it carefully onto the rear screen.

Automatic windscreen wipers

In **AUTO** mode, the windscreen wipers operate automatically and adapt to the intensity of the rainfall.

Detection is via a rain/brightness sensor, located at the top centre of the windscreen behind the rear view mirror.

! Do not cover the rain/sunshine sensor.
When using an automatic car wash, switch off the automatic wipers and the ignition.

In winter, wait until the windscreen is completely clear of ice before activating the automatic wipers.

Switching on

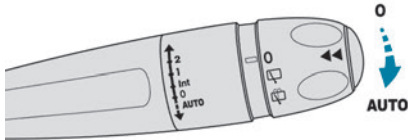

- ▶ Give a short downwards push to the control stalk.

A wiping cycle confirms that the instruction has been accepted.

 This indicator lamp lights up on the instrument panel, accompanied by a message.

Switching off

- ▶ Give the control stalk another brief push downwards or set the control stalk to another position (**Int**, **1** or **2**).

 This indicator lamp goes off on the instrument panel, accompanied by a message.

 If the ignition has been off for more than one minute, the automatic wipers must be reactivated by pushing the control stalk downwards.

Malfunction

If a fault occurs with the automatic wipers, the wipers operate in intermittent mode.

Have it checked by a PEUGEOT dealer or a qualified workshop.

General safety recommendations

! Do not remove the labels attached in different places on your vehicle. They include safety warnings as well as identification information for the vehicle.

! For all work on your vehicle, use a qualified workshop that has the technical information, skills and equipment required, all of which a PEUGEOT dealer is able to provide.

! Depending on country regulations, certain safety equipment may be mandatory: high visibility safety vests, warning triangles, breathalysers, spare bulbs, spare fuses, fire extinguisher, first aid kit, mud flaps at the rear of the vehicle, etc.

! **Installing electrical accessories**
The fitting of electrical equipment or accessories not approved by PEUGEOT may cause excessive current consumption and faults and failures with the electrical system of your vehicle. Contact a PEUGEOT dealer

for information on the range of approved accessories.

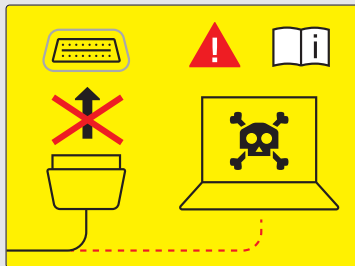

As a safety measure, access to the **diagnostic socket**, used for the vehicle's electronic systems, is reserved strictly for PEUGEOT dealers or qualified workshops, equipped with the special tools required (risk of malfunctions of the vehicle's electronic systems that could cause breakdowns or serious accidents). The Manufacturer cannot be held responsible if this advice is not followed.

Any modification or adaptation not intended or authorised by PEUGEOT or carried out without meeting the technical requirements defined by the Manufacturer will result in the suspension of the commercial warranty.

! **Installation of accessory radio communication transmitters**

Before installing a radio communication transmitter with an external aerial, you must

without fail contact a PEUGEOT dealer for the specification of transmitters which can be fitted (frequency, maximum power, aerial position, specific installation requirements), in line with the UN ECE Regulation 10.

i **Declarations of conformity for radio equipment**

The relevant certificates are available on the brand website:
<http://public.servicebox.peugeot.com/APddb/>

Event Data Recording system

(Depending on country of sale)

This vehicle is fitted with an accident data recording system, also called Event Data Recorder (EDR).

This system gathers and records certain vehicle data over a short period (a few seconds) before, during and after an event such as an accident or collision.

In order to gain a better understanding of the circumstances surrounding the event, this system records how the vehicle's various systems are operating at the time of the event, including:

- Any deployment of a restraint system (e.g. airbag, seat belt).
- The status of the seat belts of all the occupants (fastened/unfastened).

- The contact or intensity of pressure exerted on the pedal(s) engaged by the driver.
- The speed of the vehicle.
- The status of some driving and manoeuvring aids systems.

The following are not recorded by the system:

- Data on normal driving conditions, in other words data not directly related to the event.
- Personal data on the driver and any other occupants.
- The geographical location of the vehicle at the time of the event.

The reading of data recorded by the system requires the following:

- Access to the interior of the vehicle or to the system.
- And

- Special equipment that can be purchased from the manufacturer BOSCH (www.BoschCDRTool.com).

Aside from the vehicle Manufacturer, other parties such as law enforcement agencies may access this data in order to analyse the event.

Hazard warning lamps

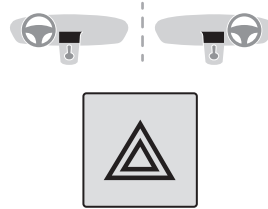

- Pressing this red button causes all the direction indicators to flash. They can work with the ignition switched off.

Automatic operation of hazard warning lamps

When braking in an emergency, depending on the rate of deceleration, the hazard warning lamps come on automatically. They switch off automatically when you next accelerate. They can be switched off by pressing the button.

Horn



- Press the central part of the steering wheel.

Pedestrian horn (Electric)

This system alerts pedestrians that the vehicle is approaching.

The pedestrian horn operates once the vehicle is moving and at speeds of up to 19 mph (30 km/h), in forward or reverse gear. This function cannot be deactivated.

Emergency or assistance call

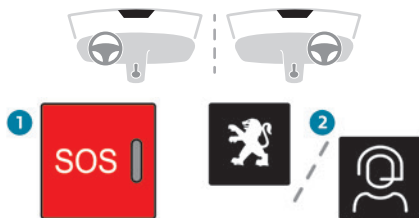

1. eCall (SOS)
2. ASSISTANCE

eCall (SOS)

Your vehicle may be fitted with the eCall (SOS) system either as standard or as an option.

The eCall (SOS) system provides direct contact to the emergency services and is fully built into the vehicle. This contact is made either automatically via the sensors built into the vehicle, or by pressing button 1.

According to the country of sale, the eCall (SOS) system corresponds to the systems PE112, ERAGLONASS, 999, etc.

The eCall (SOS) system is activated by default.

► To make an emergency call manually, press button 1 for more than 2 seconds.

The lit indicator lamp and a voice message confirm that the call has been made to the emergency services*.

The eCall (SOS) system immediately locates your vehicle and puts you in contact with the appropriate emergency services**.

► Pressing again immediately cancels the request.

The indicator lamp flashes while the vehicle data is being sent, and then remains lit when communication is established.

! In the event that a serious accident is detected by the sensors built into the vehicle, such as the airbag control unit, an emergency call is made automatically.

i The eCall (SOS) system is a public service of general interest and is free-of-charge.

Operation of the system

Vehicles equipped with Touch screen 10" & Bluetooth Radio & Telephone

- Upon switching on the ignition, the indicator lamp lights up red, then green, and then goes out: the system is operating correctly.
 - The indicator lamp flashes red: replace the back-up battery.
 - The indicator lamp is fixed red: system malfunction. The emergency and assistance call services may not work.
 - If the indicator lamp does not come on when the ignition is switched on, this also means that there is a system malfunction.
- If the problem persists, contact a qualified workshop as soon as possible.

i A system malfunction does not prevent the vehicle from being driven.

Vehicles equipped with PEUGEOT i-Connect Advanced - PEUGEOT i-Connect

- Upon switching on the ignition, the indicator lamp lights up for a few seconds and then goes out: the system is operating correctly.
- The indicator lamp flashes red: emergency battery is flat. This will be recharged after a few minutes' driving.

* In accordance with the general conditions of use of the service, available from dealers and subject to technological and technical limitations.

** Depending on the geographic coverage provided by the "eCall (SOS)" and "ASSISTANCE" systems.

The list of countries covered and the telematic services provided is available from dealers or on the website for your country.

- The indicator lamp is fixed red: system malfunction. The emergency and assistance call services may not work.
- If the indicator lamp does not light up when the ignition is turned on, this is also a system malfunction.

If the problem persists, contact a qualified workshop as soon as possible.

i A system malfunction does not prevent the vehicle from being driven.

i When an onboard system update is being performed, the eCall (SOS) function is not available.

i Data processing

All processing of personal data by the eCall (SOS) function complies with the framework for protection of personal information established by Regulation 2016/679 (General Data Protection Regulation - GDPR) or by UK GDPR (Data Protection, Privacy and Electronic Communications) Regulations 2019 and Directive 2002/58/EC of the European Parliament and the Council, and in particular, seeks to protect the vital interests of the data subject, in accordance with Article 6 (1) d) GDPR.

The processing of personal data is strictly limited to the purpose of handling the eCall (SOS) function used with the "112" single European emergency call number. The eCall (SOS) function is only able to collect and process the following data relating to the vehicle: vehicle identification number, vehicle type (passenger vehicle or light commercial vehicle), fuel type or power source, three most recent locations and direction of travel, number of passengers and a timestamped log file of the automatic activation of the system and its timestamp. The recipients of the processed data are the emergency call handling centres designated by the relevant national authorities in the territory in which they are located, enabling priority routing and handling of calls to the "112" emergency number.

i Data storage

Data contained in the system's memory is not accessible from outside the system until a call is made. The system is not traceable and is not continuously monitored in its normal operating mode. The data in the system's internal memory is automatically and continuously erased. Only the vehicle's three most recent locations,

necessary for the normal functioning of the system, are stored. When an emergency call is triggered, the data log is stored for no more than 13 hours.

i Access to data

You have the right of access to data and as appropriate to request the rectification, erasure or restriction of processing of any personal data not processed in accordance with the provisions of GDPR. Third parties to which data has been disclosed shall be notified of any rectification, erasure or restriction carried out in compliance with the corresponding GDPR, unless it proves impossible or involves a disproportionate effort.

You also have the right to lodge a complaint with the respective data protection supervisory authority.

If you want to claim your above-mentioned rights please contact us per email at: privacyrights@stellantis.com. For more information regarding our contact details please take a look at our Privacy & Cookies Policy on the brand's website.

ASSISTANCE

- ▶ If the vehicle breaks down, press button **2** for more than 2 seconds to request assistance (confirmed by a voice message*).
- ▶ Pressing again immediately cancels the request.

i Privacy mode allows you to manage the level of sharing (data and/or location) between your vehicle and PEUGEOT. It can be configured in the **Settings** touch screen menu or application, depending on the audio equipment. By default, depending on equipment, deactivate/reactivate geolocation by simultaneously pressing the 2 buttons, then press the "ASSISTANCE" button to confirm.

i If you purchased your vehicle outside the PEUGEOT dealer network, you are invited to have a dealer check the configuration of these services and, if desired, modify it as required. In a multilingual country, services can be configured to use the official national language of your choice.

i For technical reasons and in particular to improve the quality of telematics services

provided to customers, the Manufacturer reserves the right to carry out updates to the vehicle's on-board telematics system at any time.

! Vehicles equipped with PEUGEOT i-Connect Advanced

During an update to the vehicle's on-board telematics system, the ASSISTANCE system will be unavailable.

i If you benefit from the Peugeot Connect Packs offer with the SOS and Assistance Pack included, there are additional services available to you in your personal space, via the website for your country. For information about the SOS and Assistance Pack, please refer to the general conditions for these services.

Electronic stability control (ESC)

The electronic stability control programme includes the following systems:

- Anti-lock braking system (ABS) and Electronic brake force distribution (EBFD).

- Emergency braking assistance (EBA).
- Anti-slip regulation (ASR).
- Dynamic stability control (DSC).
- Trailer stability assist (TSA).

Anti-lock braking system (ABS)/Electronic brake force distribution (EBFD)

These systems enhance the vehicle's stability and handling during braking, and enable greater control while cornering, particularly on poor or slippery road surfaces.

ABS prevents wheel locking in the event of emergency braking.

Electronic brake force distribution (EBFD) manages overall braking pressure on each individual wheel.

▶ When braking in an emergency, depress the pedal very firmly and maintain this pressure.

i Normal operation of the ABS may make itself felt by slight vibrations of the brake pedal.



The fixed illumination of this warning lamp signals that there is a fault with the ABS.

The vehicle retains conventional braking. Drive carefully at a moderate speed.

* Depending on the geographic coverage of the "eCall (SOS)" and "ASSISTANCE" systems and the official national language chosen by the owner of the vehicle.

The list of countries covered and the telematic services provided is available from dealers or on the website for your country.

Have it checked by a PEUGEOT dealer or a qualified workshop.

 This warning lamp, when lit together with the **STOP** and ABS warning lamps, accompanied by a message and an audible signal, indicates an EBFD malfunction.

You must stop the vehicle.

Stop as soon as it is safe to do so and switch off the ignition.

Contact a PEUGEOT dealer or a qualified workshop.

 When changing wheels (tyres and rims), ensure that these are approved for your vehicle.

 **After an impact**
Have it checked by a PEUGEOT dealer or a qualified workshop.

Emergency braking assistance (EBA)

In an emergency, this system enables you to reach the optimum braking pressure more quickly and therefore reduce the stopping distance.

It is triggered in relation to the speed at which the brake pedal is pressed. This is felt by a reduction in the resistance of the pedal and an increase in braking efficiency.

Anti-slip regulation (ASR)/ Dynamic stability control (DSC)

Anti-slip regulation (or traction control) optimises traction by using engine braking and by applying the brakes on the driving wheels to avoid one or more wheels spinning. It also enhances the vehicle's directional stability.

If there is a difference between the vehicle's trajectory and the path desired by the driver, the dynamic stability control system automatically uses engine braking and the brakes on one or more wheels to return the vehicle to the desired path, within the limits of the laws of physics. These systems are activated automatically every time the vehicle is started.

 These systems are activated in the event of a problem with grip or trajectory (confirmed by this warning lamp flashing on the instrument panel).

Deactivation/Reactivation

In exceptional conditions (e.g. moving a vehicle that is bogged down in mud, stuck in snow, on loose soil), it may prove useful to deactivate the ASR system, so that the wheels can move freely and regain grip.

Reactivate the system as soon as the level of grip permits.

With Touch screen 10" & Bluetooth Radio & Telephone



The ASR system is deactivated/reactivated in the **Driving** touch screen menu.

With PEUGEOT i-Connect Advanced - PEUGEOT i-Connect



The ASR system is deactivated/reactivated in the **ADAS** touch screen application.



Deactivation of the ASR system is indicated by this indicator lamp on the instrument panel coming on and the display of a message.

The ASR system is automatically reactivated every time the ignition is switched off or at speeds over 31 mph (50 km/h)
Reactivation is manual below 31 mph (50 km/h).

Malfunction



In the event of a malfunction, this warning lamp lights up on the instrument panel, accompanied by the display of a message and an audible signal.

Have it checked by a PEUGEOT dealer or a qualified workshop.

ASR/DSC

These systems enhance safety during normal driving, but should not encourage the driver to take extra risks or drive at high speed.

It is in conditions of reduced grip (rain, snow, ice) that the risk of loss of grip increases. It is therefore important for your safety to keep

these systems activated in all conditions, and particularly in difficult conditions.

Correct operation of these systems depends on compliance with the manufacturer's recommendations relating to the wheels (tyres and rims), braking and electronic components, as well as the assembly and repair procedures provided by PEUGEOT dealers.

In order to ensure that these systems remain effective in wintry conditions, the use of snow or all-season tyres is recommended. All four wheels must be fitted with tyres approved for your vehicle.

All tyre specifications are listed on the tyre/paint label. For more information on **Identification markings**, refer to the corresponding section.

Trailer stability assist (TSA)

When towing, this system reduces the risk of the vehicle or trailer snaking.

Operation

The system is activated automatically when the ignition is switched on.

The electronic stability control system (ESC) must not have any faults.

The vehicle speed must be between 37 and 99 mph (60 and 160 km/h).



If the system detects that the trailer is snaking, it applies the brakes to stabilise

the trailer and reduces engine power, if necessary, to slow the vehicle (indicated by the flashing of this warning lamp on the instrument panel and the brake lamps coming on).

For more information on weights and towed loads, refer to the **Engine technical data and towed loads** section or your vehicle's registration certificate.

To ensure safe driving with a **Towing device**, refer to the corresponding section.

Malfunction



If a fault occurs, this warning lamp lights up on the instrument panel, accompanied by a message and an audible signal.

To continue towing a trailer, reduce speed and drive carefully!

Have it checked by a PEUGEOT dealer or a qualified workshop.



The trailer stability control system provides an extra safety feature under normal driving conditions, when following the recommendations for use of trailers and current legislation in force in your country. It must not encourage the driver to take extra risks, such as using a trailer in unsuitable conditions of operation (e.g. excessive load, exceeded nose weight, worn or under-inflated tyres, faulty braking system) or driving at excessive speed.

In certain cases, the system may not detect trailer snaking, particularly with a light trailer.

When driving on slippery or poor surfaces, the system may not be able to prevent sudden trailer snaking.

Advanced Grip Control

This special patented traction control system improves grip on snow, mud and sand.

For optimum grip on snow, it is recommended that you fit the vehicle with winter tyres.

For optimum system performance, contact a PEUGEOT dealer to choose the most suitable tyres.

Recommendations

The vehicle is designed principally to drive on tarmac roads, but it may occasionally drive on other less passable terrain.

However, it does not permit off-road driving:

- Driving on terrain that can damage the underbody or tear off elements (e.g. fuel pipe, fuel cooler) by obstacles or stones in particular.
- Driving on terrain with steep gradients and poor grip.
- Crossing a waterway.

Operating modes

Snow

This mode constantly adapts the level of wheel spin to offer maximum traction according to the snow conditions (a lot of wheel spin in thick snow; very little on ice). The wheel spin is also adapted to the conditions encountered when driving uphill by optimising the acceleration of the vehicle.

(mode active up to 50 mph (80 km/h))

Mud

This mode, when moving off, allows considerable spin on the wheel with the least grip to optimise clearing of the mud and to regain grip. At the same time, the wheel with the most grip is controlled in such a way as to transmit as much traction torque as possible.

When moving, the system optimises wheel spin to respond to the driver's requirements as fully as possible.

(mode active up to 31 mph (50 km/h))

Sand

This mode allows little spin on the two driving wheels at the same time to allow the vehicle to move forward and limit the risks of getting stuck in the sand.

(mode active up to 75 mph (120 km/h))

! Do not use the other modes on sand as the vehicle may become stuck.

Activation/Deactivation

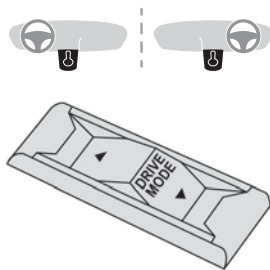

► Press the **DRIVE MODE** button; the various modes are displayed on the instrument panel.

► Select **"Snow"**, **"Mud"** or **"Sand"** depending on the context.

The chosen mode continues to be displayed in the instrument panel.

► To deactivate, select **"Normal"** mode or any other driving mode.

The system is automatically deactivated when the ignition is switched off.

Hill Assist Descent Control

Hill Assist Descent Control system for medium to steep slopes, on tarmac or other road surfaces (e.g. gravel, mud).

This system reduces the risk of slip or loss of control of the vehicle when descending, whether going forward or in reverse.

During a descent, the system assists the driver in maintaining a constant speed, depending on the gear engaged, while progressively releasing the brakes.

i For the system to activate, the gradient must be greater than 5%.

The system can be used with the gearbox in neutral.

Otherwise, engage a gear corresponding to the speed to prevent the engine stalling. With an automatic gearbox, the system can be used with the selector at **N**, **D** or **R**.

! When the system is regulating, the Active Safety Brake system is automatically deactivated.

i The system is no longer available if the speed of the vehicle is:

- above 43 mph (70 km/h).
- managed by the Adaptive cruise control, depending on the type of gearbox.

Switching on

By default, the system is not selected.

The state of the function is not saved when the ignition is switched off.

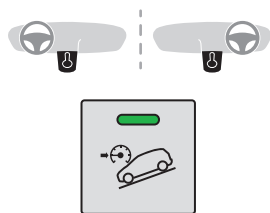

 ► To select the system, at speeds below 31 mph (50 km/h), press this button until its green indicator lamp lights up; this lamp appears in grey on the instrument panel.

 ► The system becomes active at speeds below 19 mph (30 km/h); this lamp lights up in green on the instrument panel.

► When the vehicle begins its descent, the driver can release the accelerator and brake pedals; the system regulates the speed:

 – If the gearbox is in first or second gear, the speed decreases and the indicator lamp flashes rapidly.

– If the gearbox is in neutral or if the clutch pedal is depressed, the speed decreases and the indicator lamp flashes slowly; in this case, the maintained descent speed is lower.

On a downward slope, with the vehicle stationary, if the driver releases the accelerator and brake pedals, the system will release the brakes to set the vehicle gradually in motion. The brake lamps light up automatically when the system is regulating.

If the speed exceeds 19 mph (30 km/h), regulation is paused automatically, the indicator lamp goes back to grey in the instrument panel, but the green indicator lamp in the button remains on.

Regulation resumes automatically when the speed falls below 19 mph (30 km/h) again, if the slope and pedal release conditions are met.

You can depress the accelerator or brake pedal again at any time.

Switching off

► Press the button until its indicator lamp goes off; the indicator lamp on the instrument panel goes off.

At speeds above 43 mph (70 km/h), the system is automatically deactivated; the indicator lamp in the button goes off.

Malfunction

 In the event of a malfunction, this warning lamp comes on in green on the instrument panel, accompanied by the display of a message.

Have it checked by a PEUGEOT dealer or a qualified workshop.

Seat belts

Inertia reel

The seat belts are equipped with an inertia reel which allows the strap length to adjust automatically to the shape of the user. The seat

belt returns to its storage automatically when it is not used.

The inertia reels are fitted with a device which automatically locks the strap in the event of a collision, emergency braking or if the vehicle rolls over. It can be released by pulling the strap firmly and then releasing it so that it reels in slightly.

Pyrotechnic pretensioning

This system improves safety in the event of a frontal or side impact.

Depending on the severity of the impact, the pyrotechnic pretensioning system instantly tightens the seat belts against the body of the occupants.

The pyrotechnic pretensioning seat belts are enabled when the ignition is on.

Force limiting system

This system reduces the pressure of the seat belt on the chest of the occupant, thus improving their protection.

! In the event of an impact

Depending on the nature and seriousness of the impacts, the pyrotechnic device may trigger before and independently of airbag deployment. Deployment of the pretensioners is accompanied by a slight discharge of harmless smoke and a noise, due to the activation of the pyrotechnic cartridge incorporated in the system. In all cases, the airbag warning lamp comes on.

Following an impact, have the seat belt system checked, and if necessary replaced, by a PEUGEOT dealer or a qualified workshop.

Front seat belts

The front seat belts are fitted with a pyrotechnic pretensioning system, depending on version, and a force limiting system.

Rear seat belts

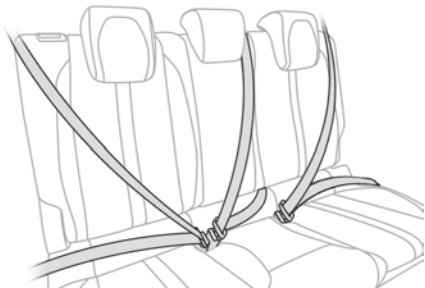

Each of the rear seats has a three-point seat belt with inertia reel.

The outer seats are fitted, depending on the version, with a pyrotechnic pretensioning and force limiting system.

Fastening

► Pull the strap, then insert the tongue into the buckle.

► Check that the seat belt is fastened correctly by pulling on the strap.

Unfastening

- Press the red button on the buckle.
- Guide the seat belt as it is reeled in.

Seat belt not fastened/unfastened alerts

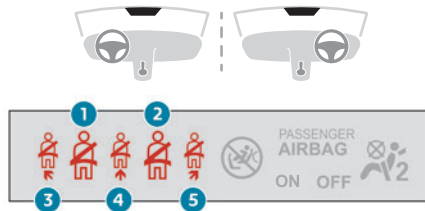

1. Front left seat belt warning lamp
2. Front right seat belt warning lamp
3. Rear left seat belt warning lamp
4. Rear centre seat belt warning lamp
5. Rear right seat belt warning lamp

Not fastened at the front

When the ignition is switched on, the warning lamp and the corresponding indicator lamps light up if the driver and/or the front passenger have not fastened their seat belts.

At a speed greater than 12 mph (20 km/h), these warning lamps flash, accompanied by an increasing audible signal for approximately two minutes. After two minutes, these warning lamps

remain on as long as the front seatbelts are not fastened.

Not fastened at the rear

When the ignition is switched on and with the engine running or the vehicle moving at a speed below 12 mph (20 km/h), the warning lamp and the corresponding indicator lamps light up for 1 minute, if one or more rear seat belts are not fastened.

Unfastened

After the ignition is switched on, the warning lamp and the corresponding indicator lamps light up if the driver and/or one or more passengers unfasten their seat belts.

At a speed greater than 12 mph (20 km/h), these warning lamps flash, accompanied by an audible signal for approximately two minutes. After this time, these warning lamps remain on as long as the seatbelts are not refastened.

Advice

- ! The driver must ensure that passengers use the seat belts correctly and that they are all fastened before setting off. Wherever seated in the vehicle, you must always fasten the seat belt, even for short journeys. Do not invert the seat belt buckles, as they will not fulfil their role properly.

To ensure the proper functioning of the belt buckles, make sure that there are no foreign bodies present (e.g. a coin) before fastening. Before and after use, ensure that the seat belt is reeled in correctly.

After folding or moving a seat or rear bench seat, ensure that the seat belt is positioned and reeled in correctly.

! Installation

The lower part of the strap must be positioned as low as possible over the pelvis. The upper part must be positioned in the hollow of the shoulder.

At the front, adjusting the position of the seat belt may require the seat height to be adjusted.

In order to be effective, a seat belt must:

- be tightened as close to the body as possible.
- be pulled in front of you with a smooth movement, checking that it is not twisted.
- must only be used to secure one person.
- not show signs of tearing or fraying.
- not be changed or modified, in order to avoid affecting its performance.

! Recommendations for children

Use a suitable child seat if the passenger is less than 12 years old or shorter than 1.5 metres.

Never use the same seat belt to secure more than one child.

Never carry a child on your lap.

For more information on **Child seats**, refer to the corresponding section.

! Maintenance

In accordance with current safety regulations, for all work on your vehicle's seat belts, contact a qualified workshop with the skills and equipment needed, which a PEUGEOT dealer is able to provide.

Have the seat belts checked regularly by a PEUGEOT dealer or a qualified workshop, particularly if the straps show signs of damage.

Clean the seat belt straps with soapy water or a textile cleaning product, sold by PEUGEOT dealers.

Airbags

General information

This system is designed to improve the safety of the occupants of the front seats and the rear outer seats in the event of a violent collision. The airbags supplement the action of the seat belts equipped with a force limiting system. Electronic detectors record and analyse the front and side impacts sustained in the impact detection zones:

– In the event of violent impact, the airbags deploy instantly and help better protect the occupants of the vehicle; immediately after the impact, the airbags deflate rapidly in order not to hinder the visibility or the possible exit of the occupants.

– In the event of a slight impact, a rear impact and under certain rollover conditions, the airbags may not deploy; only the seat belt helps to protect you in these situations.

The seriousness of the impact depends on the nature of the obstacle and the speed of the vehicle at the moment of collision.

! The airbags do not operate when the ignition is switched off.

This equipment will only deploy once. If a second impact occurs (during the same or a subsequent accident), the airbag will not be deployed again.

Impact detection zones

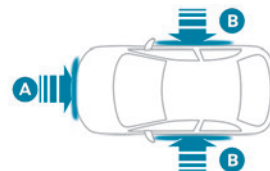

- A. Front impact zone
- B. Side impact zone

i When one or more airbags are deployed, the detonation of the pyrotechnic charge incorporated in the system makes a noise and releases a small quantity of smoke. This smoke is not harmful, but sensitive individuals may experience irritation. The detonation noise associated with the deployment of one or more airbags may result in a slight loss of hearing for a short time.

Front airbags

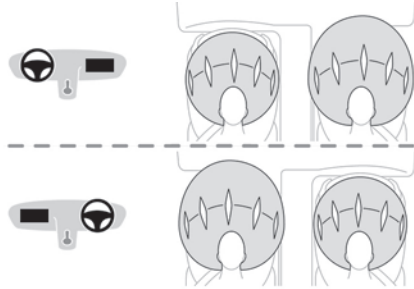

This system protects the driver and front passenger in the event of a serious front impact, limiting the risk of head and chest injury. The driver's airbag is fitted in the centre of the steering wheel; the front passenger airbag is fitted in the dashboard above the glove box.

Deployment

They are deployed, except for the front passenger airbag if it is deactivated*, in the event of a violent front impact applied to all or part of front impact zone **A**.

The front airbag inflates between the chest and head of the front occupant of the vehicle and the steering wheel, on the driver's side, and the dashboard, on the passenger's side, to cushion their forward movement.

Lateral airbags

This system protects the driver and front passenger in the event of a serious side impact, limiting the risk of injury to the chest, between the hip and the shoulder.

Each lateral airbag is fitted in the seat backrest frame, on the door side.

Deployment

The lateral airbags are deployed on one side in the event of a serious side impact applied to all or part of the side impact zone **B**.

The lateral airbag inflates between the chest of the vehicle's occupant and the corresponding door panel.

Curtain airbags

This system helps provide greater protection for the driver and passengers (with the exception

of the rear centre passenger) in the event of a serious side impact, in order to limit the risk of injury to the side of the head.

Each curtain airbag is built into the pillars and the upper passenger compartment area.

Deployment

It deploys simultaneously with the corresponding lateral airbag in the event of a serious side impact applied to all or part of the side impact zone **B**.

The curtain airbag inflates between the front and rear occupants of the vehicle and the corresponding windows.

Malfunction



In the event of a malfunction, this warning lamp lights up on the instrument panel.

Contact a PEUGEOT dealer or a qualified workshop to have the system checked.

The airbags may not be deployed in the event of a serious impact.



In the event of a minor impact or bump at the side of the vehicle or if the vehicle rolls over, the airbags may not be deployed. In the event of a rear or front collision, none of the lateral airbags are deployed.

* For more information on Deactivating the front passenger airbag, refer to the corresponding section.

Advice

! For the airbags to be fully effective, observe the safety recommendations below.

Adopt a normal and upright sitting position. Fasten your seat belt and position it correctly. Do not place anything between the occupants and the airbags (e.g. child, animal, object), do not fix or attach anything near or in the path of the airbags, as this could cause injuries when they are deployed.

Never modify the original definition of the vehicle, particularly in the area directly around the airbags.

Even if all of the precautions mentioned are observed, a risk of injury or of minor burns to the head, chest or arms cannot be ruled out when an airbag is deployed. The bag inflates almost instantly (within a few milliseconds) then deflates within the same time, discharging the hot gas via openings provided for this purpose.

After an accident or if the vehicle has been stolen, have the airbag systems checked. All work must be carried out only by a PEUGEOT dealer or a qualified workshop.

! Front airbags

Do not drive holding the steering wheel by its spokes or resting your hands on the centre part of the wheel.

Passengers must not place their feet on the dashboard.

Do not smoke as deployment of the airbags can cause burns or the risk of injury from a cigarette or pipe.

Never remove or pierce the steering wheel or hit it violently.

Do not fix or attach anything to the steering wheel or dashboard, as this could cause injuries when the airbags are deployed.

! Lateral airbags

Use only approved seat covers compatible with the deployment of these airbags. For information on the range of seat covers suitable for your vehicle, contact a PEUGEOT dealer.

Do not fix or attach anything to the seat backrests (e.g. clothing) as this could cause injuries to the chest or arm when the airbag is deployed.

Do not sit with the upper part of the body any nearer to the door than necessary.

At the rear, any objects placed on the outer seats or the folded backrest of the 1/3 bench seat could become projectiles when the lateral airbags are deployed.

The vehicle's front door panels include side impact sensors.

A damaged door or any unauthorised or incorrectly executed work (modification or repair) on the front doors or their interior trim could compromise the operation of these

sensors - risk of malfunction of the lateral airbags!

All work must be carried out only by a PEUGEOT dealer or a qualified workshop.

! Curtain airbags

Do not fix or attach anything to the roof, as this could cause head injuries when the curtain airbag is deployed.

Do not remove the grab handles installed on the roof, as these help to secure the curtain airbags.

Child seats

i The regulations on carrying children are specific to each country. Refer to the legislation in force in your country.

For maximum safety, please observe the following recommendations:

- In accordance with European regulations, **all children under the age of 12 or less than 1.5 metres tall must travel in approved child seats suited to their size or weight**, on seats fitted with a seat belt or ISOFIX mountings.
- **Statistically, the safest seats in your vehicle for carrying children are the rear seats.**
- **Children ageing less than 15 months must travel in the "rearward facing" position, whether in the front or rear of the vehicle.**

i It is **recommended** that children travel on the **rear seats** of the vehicle:

- "rearward facing" up to the age of 3.
- "forward facing" over the age of 3.

! Make sure that the seat belt is correctly positioned and tightened.

For child seats with a support leg, ensure that the support leg is in firm and steady contact with the floor.

! An incorrectly installed child seat in a vehicle compromises the child's safety in the event of an accident.

Ensure that there is no seat belt or seat belt buckle under the child seat, as this could destabilise it.

Remember to fasten the seat belts or the child seat harness keeping the slack relative to the child's body to a minimum, even for short journeys.

When installing a child seat using the seat belt, ensure that the seat belt is tightened correctly on the child seat and that it secures the child seat firmly on the vehicle seat. If the passenger seat is adjustable, move it forwards if necessary.

Remove the head restraint before installing a child seat with a backrest on a passenger seat.

Ensure that the head restraint is stored or attached securely to prevent it from being

thrown around the vehicle in the event of sharp braking. Refit the head restraint once the child seat has been removed.

! Installing a booster seat

The chest part of the seat belt must be positioned on the child's shoulder without touching the neck.

Ensure that the lap part of the seat belt passes correctly over the child's thighs.

Use a booster seat with a backrest, equipped with a belt guide at shoulder level.

! Additional protections

To prevent accidental opening of the doors and rear windows, use the "Child lock". Take care not to open the rear windows by more than one third.

To protect young children from the sun's rays, fit side blinds on the rear windows.

As a safety measure, do not leave:

- A child alone and unsupervised inside a vehicle.
- A child or an animal in a vehicle which is exposed to the sun, with the windows closed.
- The keys within reach of children inside the vehicle.

Child seat at the rear

Forward-facing or rearward-facing



► Move the vehicle's front seat forward and straighten the backrest so that the legs of the child in the forward-facing or rearward-facing child seat itself do not touch the vehicle's front seat.

► Check that the backrest of the forward-facing child seat is as close as possible to the backrest of the vehicle's rear seat, and ideally in contact with it.

Centre rear seat

A child seat with a support leg must never be installed on the **centre rear passenger seat**.

Child seat at the front



- Adjust the front passenger seat to the **highest and fully back longitudinal position, with the backrest straightened.**

"Forward facing"



- ! You must leave the front passenger airbag active.

"Rearward facing"



! The front passenger airbag must be deactivated before installing a rearward facing child seat. Otherwise, **the child risks being seriously injured or killed if the airbag is deployed.**



Warning label - Front passenger airbag

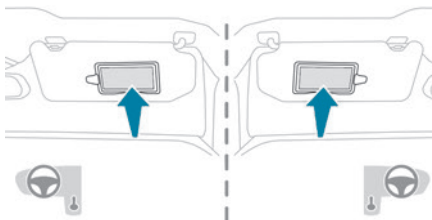

You must comply with the following instruction, as reminded by the warning label on both sides of the passenger sun visor:

NEVER use a rearward facing child restraint on a seat protected by an ACTIVE AIRBAG in front of it, DEATH or SERIOUS INJURY to the CHILD can occur.

Deactivating the front passenger airbag



Passenger airbag OFF

- ! To ensure the safety of the child, the front passenger airbag **MUST** be deactivated when a "rearward facing" child seat is installed on the front passenger seat. Otherwise, the child risks being seriously injured or killed in the event of deployment of the airbag.

- ! **Vehicles not equipped with a deactivation/reactivation control**
Installing a "rearward facing" child seat on the front passenger seat is strictly prohibited - risk of death or serious injury in the event of airbag deployment!

Deactivating/Reactivating the front passenger airbag

For vehicles on which it is fitted, the switch is located on the side of the dashboard.

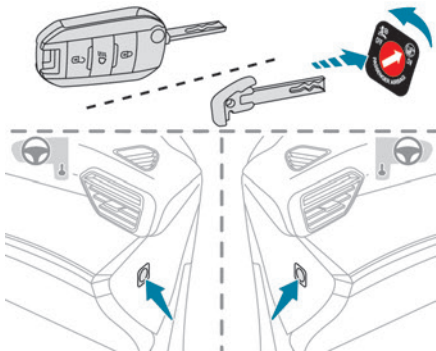

With the ignition off:

- ▶ To deactivate the airbag, turn the key in the switch to the "OFF" position.
- ▶ To reactivate it, turn the key to the "ON" position.

When the ignition is switched on:



This warning lamp comes on and remains lit to signal deactivation.

Or



This warning lamp comes on for about 1 minute to signal activation.

"ISOFIX" mountings

The seats shown below are fitted with ISOFIX compliant mountings:

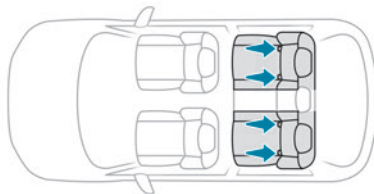

The mountings comprise three rings for each seat, indicated by a marking:

- Two rings **A**, located between the vehicle seat backrest and cushion.

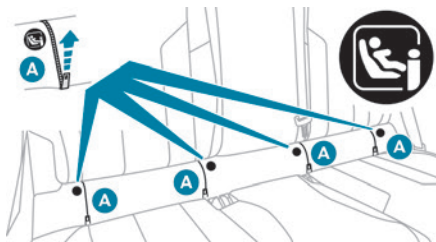

The 2 latches on **ISOFIX child seats** are secured to them.

- One ring **B**, located behind the seat, called the **TOP TETHER**, for attaching seats fitted with an upper strap.

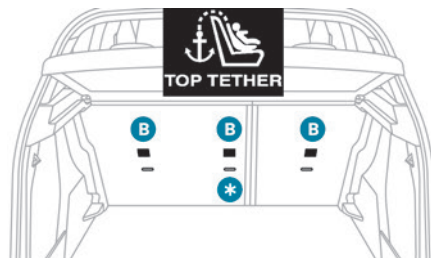

*Depending on country of sale.

This system prevents the child seat from tipping forwards in the event of a front impact.

This ISOFIX mounting system provides fast, reliable and safe fitting of the child seat in the vehicle.

To secure the child seat to the **TOP TETHER**:

- ▶ Remove and stow the head restraint before installing the child seat on this seat (refit it once the child seat has been removed).
- ▶ Pass the strap of the child seat behind the seat backrest, centring it between the openings for the head restraint rods.
- ▶ Secure the upper strap hook to ring **B**.
- ▶ Tighten the upper strap.

i When fitting an ISOFIX child seat to the left-hand rear seat of the bench seat, before fitting the seat, first move the centre rear seat belt towards the middle of the vehicle, so as to avoid the seat interfering with the operation of the seat belt.

! An incorrectly installed child seat in a vehicle compromises the child's safety in the event of an accident.

Strictly observe the fitting instructions provided in the user guide supplied with the child seat.

i For information about the options for fitting ISOFIX child seats in your vehicle, refer to the summary table.

i-Size child seats

i-Size child seats have two latches that are anchored to the two rings **A**.

These i-Size child seats also have:

- either an upper strap that is attached to ring **B**.
- or a support leg that rests on the vehicle floor, compatible with the approved i-Size seat position.

Their role is to prevent the child seat from tipping forward in the event of a collision.

For more information on the **ISOFIX mountings**, refer to the corresponding section.

Recommended child seats

"RÖMER Baby-Safe 3 i-Size"

Size: 40 - 83 cm



"RÖMER Baby-Safe 3 i-Size"

Size: 40 - 83 cm

From birth to 15 months

(up to 13 kg)

With or without its ISOFIX base.

Suitable for "rearward facing" installation only.

"RÖMER TriFix 2 i-Size"

Size: 76 - 105 cm



"RÖMER TriFix 2 i-Size"

Size: 76 - 105 cm

From 15 months to 4 years

(from 9 to 22 kg)

Installed with ISOFIX and Top Tether mountings.

Suitable for "forward facing" installation only.

"RÖMER KidFix i-Size"

Size: 100 - 150 cm

**From 3.5 to 12 years**

(from 15 to 36 kg)

Can be installed with or without ISOFIX mountings.

The child is restrained by the seat belt.

restraint), refer to the list of vehicles provided in the child restraint user manual.

i Ensure that the installation location of the child restraint system inside the vehicle is correct.

Refer to the summary table for the installation of child seats.

"GRACO Booster"

Size: over 135 cm



(from 22 to 36 kg)



The child is restrained by the seat belt.



i Please follow the child restraint manufacturers' instructions for installing the appropriate child restraint in the vehicle.

i For the semi-universal or vehicle-specific child restraint (ISOFIX or belt-type child

Summary table for installation of universal, ISOFIX and i-Size child seats

In compliance with European regulations, this table indicates the options for installing child seats using the seat belt and universally approved (a) as well as the largest **ISOFIX** and **i-Size** child seats for the seat positions equipped with **ISOFIX** mountings in the vehicle.

	Seat numbers					
	Front seats (b) (j)		Rear seats (b)			
	1	3	4	5	6	
	3	1	4	5	6	
Front passenger airbag		Deactivated "OFF" (c)	Activated "ON" (d)			
Position compatible with a universal (a) child seat Rearward facing	no	yes (e) (h) (n)	no	yes	yes (k)	yes
Position compatible with a universal (a) child seat Forward facing	no	yes (f) (h) (n)	yes (f) (h) (n)	yes	yes (k)	yes
Position compatible with an i-Size child seat Rearward facing	no	no		yes	no	yes
Position compatible with an i-Size child seat Forward facing	no	no		yes	no	yes
Position equipped with a Top Tether hook	no	no		yes	no	yes

	Seat numbers					
	Front seats (b) (j)		Rear seats (b)			
	1	3		4	5	6
	3	1		4	5	6
Front passenger airbag		Deactivated "OFF" (c)	Activated "ON" (d)			
"Carrycot" type of child seat (L1 / L2)	no	no		yes (l)	no	yes (l)
"Rearward facing" ISOFIX child seat (R1 / R2 / R3)	no	no		R3 (g) (i)	no	R3 (g) (i)
"Forward facing" ISOFIX child seat (F2 / F2X / F3)	no	no		F3	no	F3
"Booster" child seat (B2 / B3)	no	no		B3	no	B3 (m)

Rules:

- A position that is **i-Size** compatible is also compatible for **R1**, **R2** and **F2X**, **F2**, **B2**.
- A position that is **R3** compatible is also compatible for **R1** and **R2**.
- A position that is **R2** compatible is also compatible for **R1**.
- A position that is **F3** compatible is also compatible for **F2X** and **F2**.
- A position that is **B3** compatible is also compatible with **B2**.

- (a) Universal child seat: child seat that can be installed in all vehicles using the seat belt.
- (b) Depending on version, refer to the legislation in force in your country before installing a child in this seat position.
- (c) To install a "**rearward facing**" child seat at this seat position, the front passenger's airbag **MUST** be deactivated ("**OFF**").
- (d) Only a "**forward facing**" child seat is authorised at this seat position with the front passenger's airbag activated ("**ON**").
- (e) For a "**rearward facing**" and/or "**forward facing**" universal child seat (**U**) in groups **0**, **0+**, **1**, **2** or **3**, or dedicated to children between 40 and 150 cm in size.
- (f) For a "**forward facing**" universal child seat (**UF**) in groups **1**, **2** or **3**, or dedicated to children between 76 and 150 cm in size.

- (g) Adjust the front passenger seat to the fully forward longitudinal position.
- (h) For a seat with height adjustment, set it to the highest and fully back longitudinal position.
- (i) Adjust the height-adjustable front driver seat to the maximum height position.
- (j) Seats not fitted with ISOFIX compliant mountings.
- (k) A child seat with a support leg must never be installed on the centre rear passenger seat.
- (l) The installation of a carrycot on this seat may prevent the use of one or more of the other seats in this row.
- (m) Do not fold down the backrest.
- (n) For a seat without height adjustment, the backrest must be in an upright position and the seat in fully back longitudinal position.

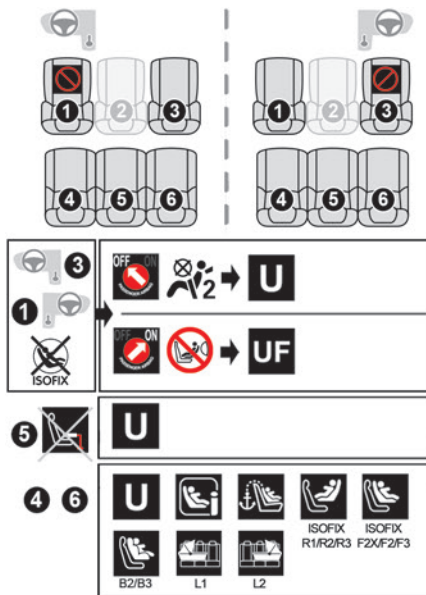

Key

- Seat position where the installation of a child seat is forbidden.
- Front passenger airbag **deactivated**.
- Front passenger airbag **activated**.
- Seat position suitable for the installation of a child seat secured using the seat belt and **universally approved "rearward facing"**

and/or "forward facing" (U) for all sizes and weight groups.

UF Seat position suitable for the installation of a child seat secured using the seat belt and **universally approved "forward facing" (UF)** for groups **1, 2** and **3**, or dedicated to children between 76 and 150 cm in size only.

Seat position authorised for the installation of an **i-Size** child seat.

Seat position not suitable for the installation of a child seat with support leg.

Seat position authorised for the installation of a **"forward facing" i-Size** child seat.

Presence of a **Top Tether** anchorage point at the rear of the backrest, authorising the installation of an **universal ISOFIX child seat**.

Presence of a **Top Tether** anchorage point at the rear of the backrest, authorising the installation of a **"forward facing" universal ISOFIX child seat**.

"Rearward facing" **ISOFIX** child seat:

- **R1**: **ISOFIX** child seat for a **baby**.
- **R2**: **ISOFIX reduced size** child seat.
- **R3**: **ISOFIX large size** child seat.

"Forward facing" **ISOFIX** child seat:

- **F2X**: **ISOFIX** child seat for **toddlers**.
- **F2**: **ISOFIX reduced height** child seat.
- **F3**: **ISOFIX full height** child seat.



Booster child seat:

- B2: reduced width booster seat.
- B3: full width booster seat.



ISOFIX "carrycot" type child seat:

- L1: left-hand facing.
- L2: right-hand facing.



Seat position authorised for the installation of an **ISOFIX** child seat.



Seat position where the installation of an **ISOFIX** child seat is forbidden.

For seat adjustments, refer to the summary table "Installing universal, ISOFIX and i-Size child seats".

Manual child lock



The system prevents a rear door from being opened using its interior handle. The red control is located on the edge of each rear door (marked by a label).

Activation/Deactivation

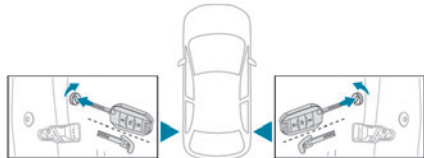

- ▶ To activate the child lock, turn the built-in key in the **red** control as far as possible:
 - To the right on the left-hand rear door.
 - To the left on the right-hand rear door.
- ▶ To deactivate the child lock, turn the key in the opposite direction.

! Do not confuse the child lock control, which is red, with the back-up locking control, which is black.

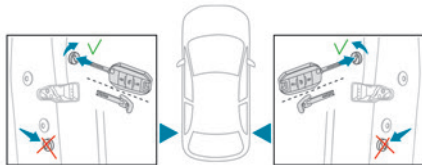

Electric child lock

Depending on version, this system prevents the opening of the rear doors using their interior handles and/or the use of the rear electric window controls.

Versions with 1 control



Electric windows only

This control supplements the manual child lock for the rear doors.



Doors and electric windows

Versions with 2 controls



Doors only/Electric windows only

Activation/Deactivation

► With the ignition on, press the corresponding button to activate/deactivate the child lock (confirmed by the corresponding indicator lamp coming on/going out).

The activation/deactivation of the child lock is also indicated by the display of a message.

! Any other status of the indicator lamp indicates a malfunction of the electric child lock.

Have it checked by a PEUGEOT dealer or a qualified workshop.

i With the child lock activated, it is still possible to open the rear doors from outside and/or to operate the rear electric windows from the driver's door.

! This system is independent and in no circumstances does it take the place of the central locking control.

Check the status of the child lock each time you switch on the ignition.

Always keep the electronic key with you when leaving the vehicle, even for a short time.

In the event of a serious impact, the electric child lock is switched off automatically to permit the exit of the rear passengers.

Driving recommendations

- ▶ Observe the driving regulations and remain vigilant whatever the traffic conditions.
- ▶ Monitor your environment and keep your hands on the wheel to be able to react to anything that may happen any time.
- ▶ Drive smoothly, anticipate the need for braking and maintain a longer safety distance, especially in bad weather.
- ▶ Stop the vehicle before performing operations that require sustained attention (e.g. settings).
- ▶ During long trips, take a break every 2 hours.

Important!

! Never leave the engine running in a closed space without sufficient ventilation. Internal combustion engines emit toxic exhaust gases such as carbon monoxide. Danger of poisoning and death!

! In very severe wintry conditions (temperature below -23°C), let the engine run for 4 minutes before moving off, to ensure the correct operation and durability of the mechanical components of your vehicle (engine and gearbox).

! Never drive with the parking brake applied. Risk of overheating and damaging the braking system!

! Never park the vehicle and never leave the engine running on a flammable surface (e.g. dry grass, dead leaves). The vehicle exhaust system is very hot, even several minutes after the engine stops. Risk of fire!

! Never drive on surfaces covered with vegetation (e.g. tall grass, accumulated dead leaves, crops, debris) such as a field, a country lane overgrown with bushes or a grassy verge.

This vegetation could come into contact with the vehicle's exhaust system or other systems which are very hot. Risk of fire!

! Make sure you do not leave any item in the passenger compartment which could act like a magnifying glass under the effect of the sun's rays and cause a fire. Risk of fire or damage to interior surfaces!

! Never leave the vehicle unattended, with the engine running. If you have to leave your vehicle with the engine running, apply the parking brake and put the gearbox or drive selector into neutral or position **N** or **P** (depending on version).

! Never leave children inside the vehicle unsupervised.

On flooded roads

We strongly advise against driving on flooded roads, as this could cause serious damage to the engine or gearbox, as well as to your vehicle's electrical systems.

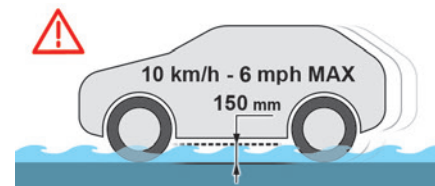

If the vehicle absolutely must drive through a flooded section of road:

- ▶ Check that the depth of the water does not exceed 15 cm, taking account of waves that might be generated by other users.
 - ▶ Deactivate the Stop & Start function.
 - ▶ Drive as slowly as possible without stalling. In all cases, do not exceed 6 mph (10 km/h).
 - ▶ Do not stop and do not switch off the engine.
- On leaving the flooded road, as soon as safety conditions allow, make several light brake applications to dry the brake discs and pads. If in doubt about the state of your vehicle, contact a PEUGEOT dealer or a qualified workshop.

Noise (Electric)

On the outside

Due to the vehicle's quiet operation when driving, the driver must pay particular attention. When manoeuvring, the driver must always check the vehicle's immediate surroundings. At speeds of up to 19 mph (30 km/h), the pedestrian horn warns other road users of the vehicle's presence.

Cooling the traction battery

The cooling fan comes on during charging to cool the on-board charger and the traction battery.

On the inside

During use, you may hear certain perfectly normal noises specific to electric vehicles, such as:

- Traction battery relay when starting.
- Vacuum pump when braking.
- Vehicle tyres or aerodynamics when driving.
- Jolting and knocking noise during hill starts.

Towing

 Driving with a trailer places greater demands on the towing vehicle and particular care must be taken.

 Do not exceed the maximum towable weights.

At altitude: reduce the maximum load by 10% per 1,000 metres of altitude; the lower air density at high altitudes decreases engine performance.

 **New vehicle:** do not tow a trailer until the vehicle has driven at least 620 miles (1,000 kilometres).

 If the outside temperature is high, let the engine idle for 1 to 2 minutes after the vehicle comes to a stop, to help it to cool.

Before setting off

Nose weight

▶ Distribute the load in the trailer so that the heaviest items are located as close as possible to the axle, and the nose weight (at the point where it joins your vehicle) approaches the maximum permitted, without exceeding it.

Tyres

▶ Check the tyre pressures of the towing vehicle and of the trailer, observing the recommended pressures.

Lighting

▶ Check the electrical signalling on the trailer and the headlamp beam height of your vehicle.

 If a genuine PEUGEOT towing device is used, the rear parking sensors will be deactivated automatically to avoid activating the audible signal.

When driving

Cooling

Towing a trailer uphill causes the coolant temperature to increase. The maximum towable load depends on the gradient and the exterior temperature. The fan's cooling capacity does not increase with engine speed.

- ▶ Reduce speed and lower the engine speed to limit the amount of heating produced.
- ▶ Pay constant attention to the coolant temperature.



If this warning lamp and the **STOP** warning lamp come on, stop the vehicle and switch off the engine as soon as possible.

Brakes

Using the engine brake is recommended to limit the overheating of the brakes. Braking distances are increased when towing a trailer.

Side wind

Bear in mind that the vehicle will be more susceptible to wind when towing.

Anti-theft protection

Electronic immobiliser

The keys contain a code, which must be recognised by the vehicle before starting is possible.

If the system malfunctions, indicated by the display of a message, the engine will not start. Contact a PEUGEOT dealer.

Starting / Switching off the engine with the key

Key ignition switch

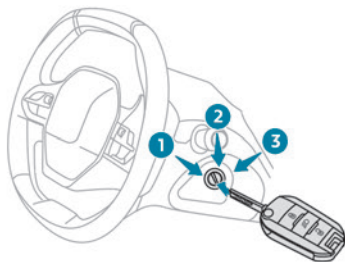

It has 3 positions:

1. Stop

Inserting/removing the key, steering column locked.

2. Ignition on

Steering column unlocked, ignition on, preheating (Diesel), switching the engine on.

3. Starting

i Avoid attaching heavy objects to the key or the remote control. This would weigh down on its shaft in the ignition switch and could cause a malfunction.

Ignition on position

It allows the use of the vehicle's electric equipment or the charging of accessories. Once the state of charge of the battery drops to the reserve level, the system switches to energy economy mode. The power supply is cut off automatically to preserve the remaining battery charge.

Starting the engine

With the parking brake applied:

- ▶ With a **manual gearbox**, place the gear lever in neutral then fully depress the clutch pedal.
- ▶ With an **automatic gearbox**, place the gear selector in mode **N** or **P** then depress the brake pedal.
- ▶ Insert the key into the ignition switch; the system recognises the code.
- ▶ Unlock the steering column by simultaneously turning the steering wheel and the key.

i In certain cases, you may need to apply significant force to move the steering wheel (e.g. wheels turned to full lock).

- ▶ With a **petrol engine**, operate the starter motor by turning the key to position **3** without pressing the accelerator pedal, until the engine starts. Once the engine has started, release the key and allow it to return to position **2**.

i Petrol engines

After a cold start, preheating the catalytic converter can cause noticeable engine vibrations, for anything up to 2 minutes (accelerated idle speed).

- ▶ With a **Diesel engine**, turn the key to position **2**, to activate the engine preheating system.



Wait until this warning lamp goes off on the instrument panel, then turn the key to position **3** without pressing the accelerator pedal, to operate the starter motor. Once the engine has started, release the key and allow it to return to position **2**.

i In wintry conditions, the warning lamp may stay on for a longer period. When the engine is hot, the warning lamp does not come on. In mild conditions, do not leave the engine to warm up while stationary, but move off straight away and drive at moderate speed.

! If the engine does not start straight away, switch off the ignition. Wait a few seconds before operating the starter motor again. If the engine does not start after a few attempts, do not keep trying - risk of damaging the starter motor and the engine! Contact a PEUGEOT dealer or a qualified workshop.

Switching off the engine

- ▶ Immobilise the vehicle.
- ▶ With the engine at idle, turn the key to position **1**.
- ▶ Remove the key from the ignition switch.
- ▶ To lock the steering column, turn the steering wheel until it locks.

i To facilitate unlocking of the steering column, it is recommended that the wheels be returned to the straight ahead position before switching off the engine.

! Never switch off the ignition before the complete immobilisation of the vehicle. With the engine off, the braking and steering assistance systems are also cut off - risk of loss of control of the vehicle!

i Check that the parking brake is correctly applied, particularly on sloping ground. When leaving the vehicle, keep the key in your possession and lock the vehicle.

Energy economy mode

After the engine has stopped (position **1. Stop**), for a maximum combined duration of 30 minutes, you can still use functions such as the audio and telematics system, courtesy lamps or dipped beam headlights.

i For more information on **Energy economy mode**, refer to the corresponding section.

i **Key left in**
When the driver's door is opened, a message is displayed, accompanied by an audible signal, if the key has been left in the ignition switch in position **1**. If the key has been left in the ignition switch in position **2**, the ignition will be switched off automatically after one hour. To switch the ignition back on, turn the key to position **1**, then back to position **2**.

Starting/Switching off the engine with Keyless Entry and Start

i The electronic key must be present in the passenger compartment. The electronic key is also detected in the boot.

If the electronic key is not detected, a message is displayed. Move the electronic key so that the engine can be started or switched off. If there is still a problem, refer to the "**Key not detected - Back-up starting or Back-up switch-off**" section.

Starting



- ▶ With a **manual gearbox**, place the gear lever in neutral and fully depress the clutch pedal.
- ▶ With an **automatic gearbox**, select mode **P** or **N** and depress the brake pedal.
- ▶ Press the "**START/STOP**" button while maintaining pressure on the pedal until the engine starts.

Diesel engines

In negative temperatures and/or when the engine is cold, starting takes place only after the preheating warning lamp goes out.

 If this warning lamp comes on after pressing the "**START/STOP**" button:

► Keep the pedal fully depressed and do not press the "**START/STOP**" button again until the engine is running.

In all circumstances, if one of the starting conditions is not met, a message is displayed. In some circumstances, a message indicates that it is necessary to turn the steering wheel while pressing the "**START/STOP**" button to assist unlocking of the steering column.

i Petrol engines

With Petrol engines, after a cold start, pre-heating the catalytic converter can cause noticeable engine vibrations, for anything up to 2 minutes (accelerated idle speed).

i If the engine stalls, release the clutch pedal and fully depress it again, the engine will restart automatically.

Switching off

- Immobilise the vehicle using the parking brake.
- With a **manual gearbox**, ideally put the gear lever into neutral.
- With an **automatic gearbox**, ideally select mode **P** or **N**.
- Press the "**START/STOP**" button.

In some circumstances, it is necessary to turn the steering wheel to lock the steering column.

i If the vehicle is not immobilised, the engine will not stop.

! With the engine off, the braking and steering assistance systems are also cut off - risk of loss of control of the vehicle!

! Never leave your vehicle with the electronic key still inside.

Starting/Switching off the electric motor

Starting

The drive selector must be in mode **P**.

- Fully depress the brake pedal and briefly press the "**START/STOP**" button.
- Keep your foot on the brake pedal until the **READY** indicator lamp comes on and an audible signal is emitted, indicating that the vehicle is ready to drive.
- With your foot on the brake, press the "**Unlock**" button and select mode **D/B** or **R**.
- Release the brake pedal, then accelerate. On starting, the instrument panel lights up and the power indicator needle or cursor moves to the "neutral" position. The steering column automatically unlocks (you may hear a sound and feel the steering wheel move).

Switching off

- Press the "**START/STOP**" button. Before exiting the vehicle, check that:
 - The drive selector is in mode **P**.
 - The **READY** indicator lamp is off.

i If the driver's door is opened while the required conditions for stopping are not satisfied, an audible signal is emitted, accompanied by the display of a warning message.

Switching on the ignition without starting the engine



With the electronic key in the passenger compartment, pressing the "**START/STOP**" button, **without depressing any of the pedals**, allows the ignition to be switched on without starting the engine.

- Press this button again to switch off the ignition and allow the vehicle to be locked.

Key not detected

Back-up starting

A back-up reader is fitted to the steering column, to enable the engine to be started if the system

fails to detect the key in the recognition zone, or if the battery in the electronic key is flat.

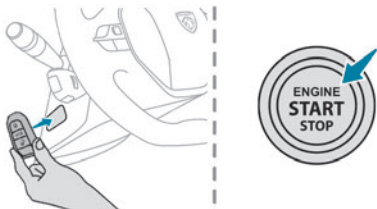

- ▶ Place and hold the remote control against the back-up reader.
- ▶ **With a manual gearbox**, place the gear lever in neutral, then fully depress the clutch pedal.
- ▶ **With an automatic gearbox or a drive selector**, select mode **P**, then depress the brake pedal.
- ▶ Press the "**START/STOP**" button. The engine starts.

Back-up switch-off



If the electronic key is not detected or is no longer in the recognition zone, a message appears in the instrument panel when closing a door or trying to switch off the engine.

- ▶ To confirm the instruction to switch off the engine, press the "**START/STOP**" button for approximately 5 seconds.
- In the event of a fault with the electronic key, contact a PEUGEOT dealer or a qualified workshop.

Emergency switch-off

In case of emergency only, the engine can be switched off without conditions (even when driving).

- ▶ Press the "**START/STOP**" button for about 5 seconds.

In this case, the steering column locks as soon as the vehicle stops.

Manual parking brake

Release

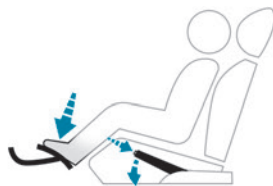

- ▶ Pull the parking brake lever up slightly, press the release button, then lower the lever fully.

 When driving the vehicle, if this warning lamp and the **STOP** warning lamp come on, accompanied by an audible signal and the display of a message, this means that the parking brake is still applied or has not been fully released.

Application

- ▶ Pull the parking brake lever up to immobilise the vehicle.

 When parking on a slope, turn the wheels against the kerb, apply the parking brake, engage a gear and switch off the ignition.

Electric parking brake

In automatic mode, this system applies the parking brake when the engine is switched off and releases it when the vehicle moves off.

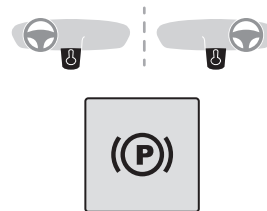

At any time, with the engine running:

► To apply the parking brake, briefly pull the control.

► To release it, briefly push the control while pressing the brake pedal.

Automatic mode is activated by default.

This automatic operation can be deactivated in certain situations.

Indicator lamp



This indicator lamp comes on both on the instrument panel and on the control to confirm that the parking brake has been applied, accompanied by display of the message **"Parking brake applied"**.

The indicator lamp goes out to confirm the release of the parking brake, accompanied by the display of the message **"Parking brake released"**.

The indicator lamp flashes in response to a manual request to apply or release the brake.

- ! In the event of a battery failure, the electric parking brake will not operate. As a safety measure, with a manual gearbox, if the parking brake is not applied, immobilise the vehicle by engaging a gear.
- As a safety measure, with an automatic gearbox or drive selector, if the parking brake is not applied, immobilise the vehicle by placing the supplied chock against one of the wheels.
- Contact a PEUGEOT dealer or a qualified workshop.

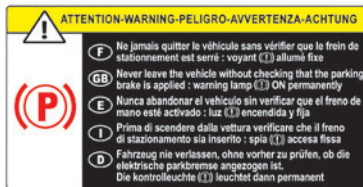

! Before leaving the vehicle, check that the parking brake is applied: the parking brake indicator lamps on the instrument panel and the control must be on fixed.

If the parking brake is not applied, there is an audible signal and a message is displayed on opening the driver's door.

! Never leave a child alone inside the vehicle, as they could release the parking brake.

! **When the vehicle is parked: on a steep slope, heavily loaded or during towing**

With a manual gearbox, turn the wheels toward the pavement and engage a gear. With an automatic gearbox or a drive selector, turn the wheels toward the pavement and select mode **P**. When towing, the vehicle is approved for parking on slopes of up to 12%.

Manual operation

Manual release

With the ignition on or engine running:

- Press the brake pedal.
- While maintaining pressure on the brake pedal, briefly push the control.

i If the brake pedal is not depressed, the parking brake is not released and a message is displayed.

Manual application

With the vehicle stationary:

- Briefly pull the control.
- The control indicator lamp flashes to confirm the application request.

Automatic operation

Automatic release

First ensure that the engine is running and that the driver's door is closed.

The electric parking brake gradually releases automatically as the vehicle moves off.

With a manual gearbox

- Fully depress the clutch pedal and engage first gear or reverse.
- Depress the accelerator pedal and release the clutch pedal.

With an automatic gearbox

- Depress the brake pedal.

- ▶ Select mode **D**, **M** or **R**.
- ▶ Release the brake pedal and depress the accelerator pedal.

With a drive selector

- ▶ Depress the brake pedal.
- ▶ Select mode **D**, **B** or **R**.
- ▶ Release the brake pedal and depress the accelerator pedal.

i With an automatic gearbox or drive selector, if the brake does not release automatically, check that the front doors are properly closed.

! When stationary with the engine running, do not depress the accelerator pedal unnecessarily. Risk of parking brake release.

Automatic application

With the vehicle stationary, the parking brake is applied automatically when the engine is switched off.

! It is not applied automatically if the engine stalls or enters STOP mode with Stop & Start.

i In automatic mode, the parking brake can be manually applied or released at any time using the control.

Special cases

Immobilising the vehicle with the engine running

To immobilise the vehicle with the engine running, briefly pull the control.

Parking the vehicle with the brake released

! In very cold conditions (ice), applying the parking brake is not recommended. To immobilise the vehicle, engage a gear or place the chocks against one of the wheels.

i With an automatic gearbox or drive selector, mode **P** is automatically selected when the ignition is switched off. The wheels are blocked. For more information on **Free-wheeling**, refer to the corresponding section.

i With an automatic gearbox or a drive selector, if you open the driver's door while mode **N** is engaged, an audible signal will sound and mode **P** will be engaged. The audible signal stops when the driver's door is closed.

Deactivating automatic operation

In some situations, for example when it is extremely cold or when towing (e.g. caravan, breakdown), it may be necessary to deactivate automatic operation of the system.

- ▶ Start the engine.
- ▶ Use the control to apply the parking brake, if it is released.
- ▶ Take your foot fully off the brake pedal.
- ▶ Keep the control pushed in the release direction for 10 to a maximum of 15 seconds.
- ▶ Release the control.
- ▶ Depress and hold the brake pedal.
- ▶ Pull the control in the application direction for 2 seconds.



This indicator lamp on the instrument panel comes on to confirm deactivation of the automatic functions.

- ▶ Release the control and the brake pedal. From this point onwards, only the manual functions, using the control, allow the parking brake to be applied and released.
- ▶ Follow this procedure again to reactivate automatic operation (confirmed by the indicator lamp on the instrument panel going out).

Emergency braking

If depressing the brake pedal fails to provide effective braking or in exceptional circumstances (e.g. driver unwell, assisted driving), the vehicle can be braked by sustained pulling on the

electric parking brake control. Braking continues for as long as the control is kept pulled, and ceases when the control is released. The ABS and DSC systems stabilise the vehicle during emergency braking.

If emergency braking malfunctions, the message "**Parking brake fault**" will be displayed on the instrument panel.



If the ABS and DSC systems malfunction, indicated by lighting one or both warning lamps on the instrument panel, the vehicle's stability is no longer ensured.

► In this case, ensure the vehicle's stability by successive and repeated "pull-release" actions on the electric parking brake control until the vehicle comes to a complete stop.

6-speed manual gearbox

Engaging 5th or 6th gear

► Move the gear selector fully to the right to engage 5th or 6th gear.

! Failure to follow this instruction could cause permanent damage to the gearbox (inadvertent engagement of 3rd or 4th gear).

Engaging reverse gear



► Raise the ring under the knob and move the gear selector to the left, then forwards.

! Only engage reverse gear when the vehicle is stationary with the engine at idle.

i As a safety precaution and to facilitate engine starting:

- Always select neutral.
- Press the clutch pedal.

Automatic gearbox (EAT6)

6-speed automatic gearbox which offers a choice between the comfort of automatic operation or manual gear changing.

Two driving modes are available:

- **Automatic** operation for electronic management of the gears by the gearbox.
- **Manual** operation for sequential changing of the gears by the driver.

Gear selector module

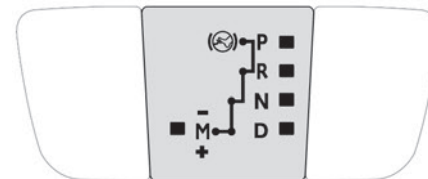

- P.** Park
 - Vehicle immobilised, parking brake applied or released.
 - Engine starting.
- R.** Reverse
 - Reversing manoeuvres, vehicle stationary, engine at idle.
- N.** Neutral
 - Vehicle immobilised, parking brake applied.
 - Engine starting.
- D.** Automatic operation
- M. +/-** Manual operation
 - To shift up/down through the gears, push the control backwards/forwards.

Information displayed on the instrument panel

When a position is selected in the grid with the gear selector, the corresponding indicator lamp lights up on the instrument panel.

- P.** Park
- R.** Reverse

- N.** Neutral
- D.** Drive (automatic operation)
- 1...6.** Gear engaged during manual operation
- .** Instruction not accepted during manual operation

Starting the vehicle



▶ With your foot on the brake pedal, select position **P** or **N**.

▶ Start the engine.

If the conditions are not met, you will hear an audible signal, accompanied by the display of a message.

- ▶ With the engine running, depress the brake pedal.
- ▶ Release the parking brake, unless it is set to automatic mode.
- ▶ Select position **R**, **D** or **M**.
- ▶ Gradually release the brake pedal.

The vehicle moves off immediately.

i If position **N** is selected inadvertently while driving, allow the engine to return to idle, then select position **D** to accelerate.

! When the engine is running at idle with the brakes released, if position **R**, **D** or **M** is selected, the vehicle moves off even without the accelerator being pressed. Never leave children unattended in the vehicle when the engine is running.

When carrying out maintenance with the engine running, apply the parking brake and select position **P**.

Automatic operation

▶ Select position **D** for **automatic** changing of the six gears.

The gearbox then operates in auto-adaptive mode, without any intervention on the part of the driver. It continuously selects the most suitable gear according to the driving style, the road profile and the load in the vehicle.

For maximum acceleration without touching the selector, press the accelerator fully down (kick-down). The gearbox changes down automatically or holds the gear selected until the maximum engine speed is reached.

When braking, the gearbox changes down automatically to provide effective engine braking. If you release the accelerator sharply, the gearbox will not shift to a higher gear for safety reasons.

! Never select position **N** while the vehicle is moving.

Never select positions **P** or **R** unless the vehicle is completely stationary.

Manual operation



To limit fuel consumption during an extended standstill with the engine

running (for example, in a traffic jam), set the gear selector to **N** and apply the parking brake.

- ▶ Selecting position **M** enables sequential shifting between the six gears.
- ▶ To shift up/down through the gears, push the control backwards/forwards.

The gearbox only changes gear if the vehicle speed and engine speed conditions allow; otherwise, the rules for automatic operation are temporarily applied.

M4 **D** disappears, and the gears engaged appear in succession on the instrument panel.

If the engine speed is too low or too high, the selected gear flashes for a few seconds, then the gear actually engaged is shown.

It is possible to change from position **D** to position **M** at any time.

When the vehicle is stationary or moving very slowly, the gearbox selects gear **M1** automatically.



This symbol is displayed if a gear is not engaged correctly (gear selector between two positions).

Switching off the vehicle

Before switching off the engine, it is possible to engage position **P** or **N** to place the gearbox in neutral.

In both cases, apply the parking brake to immobilise the vehicle, unless it is set to automatic mode.

- i** If the gear selector is not in position **P**, when the driver's door is opened or approximately 45 seconds after the ignition is switched off, an audible signal sounds and a message appears.
 - ▶ Return the gear selector to **P**; the audible signal stops and the message disappears.

Malfunction



In the event of a malfunction, this warning lamp comes on and a message is displayed, when the ignition is switched on. In this case, the gearbox goes into back-up mode and is locked in 3rd gear. You may feel a significant jolt (without risk to the gearbox) when changing from **P** to **R** and from **N** to **R**. Do not exceed 62 mph (100 km/h), local speed restrictions permitting. Have it checked by a PEUGEOT dealer or a qualified workshop.

- !** There is a risk of damaging the gearbox:
 - If the accelerator and brake pedals are depressed simultaneously.
 - In the event of a battery failure, forcing the selector from position **P** to another position.

Automatic gearbox (EAT8)

Automatic 8-speed gearbox with push selector. It also offers a manual mode with gear changes via control paddles located behind the steering wheel.

Push selector

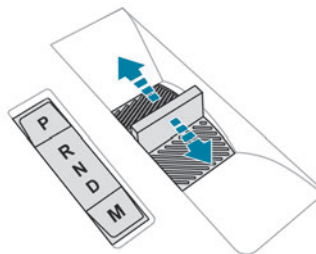

- P.** Auto Park
Press this button to switch to Parking mode. For parking the vehicle: the front wheels are blocked.
- R.** Reverse
- N.** Neutral
To free-wheel and move the vehicle, with the ignition off. For more information on **Free-wheeling**, refer to the corresponding section.
- D.** Driving in automatic mode
The gearbox manages gear changes according to the style of driving, the road profile and the vehicle load.

- M.** Driving in manual mode
Press this button to switch to manual mode. The driver changes gear using the steering-mounted controls.

- ▶ In mode **N**, with your foot on the brake pedal, push without passing the point of resistance:
 - Forwards, mode **R** is selected.
 - Backwards, mode **D** is selected.

Release the selector fully after each push; it will then return to its initial position.

Special cases

To avoid mode **N** (quick change from **D** to **R** and back again):

- ▶ In mode **R**, push backwards past the point of resistance, mode **D** is selected.
- ▶ In mode **D**, push forwards past the point of resistance, mode **R** is selected.
- ▶ To return to mode **N**, push without passing the point of resistance.

Steering-mounted controls

(Depending on equipment)

In mode **M** or **D**, the steering-mounted control paddles can be used to change gear manually. They cannot be used to select neutral or to engage or disengage reverse gear.



- Pull the "+" or "-" paddle towards you and release to shift up or down a gear, respectively.

Information displayed on the instrument panel

When the ignition is switched on, the gearbox status is displayed on the instrument panel:

P	Parking
R	Reverse
N	Neutral
D1...8	Automatic forward gear
M1...8	Manual forward gear

The state of the gearbox remains displayed on the instrument panel for a few seconds after switching off the ignition.

Operation

Only appropriate mode change instructions are validated.

With the engine running, if it is necessary to depress the brake pedal to change modes,

an alert message will be displayed on the instrument panel.

! With the engine running and the brakes released, if **R**, **D** or **M** is selected, the vehicle moves off, even without pressing the accelerator pedal.

Never depress the accelerator and brake pedals at the same time - risk of damage to the gearbox!

i If you open the driver's door while mode **N** is engaged, an audible signal will sound and mode **P** will be engaged. The audible signal stops when the driver's door is closed.

! At speeds below 3 mph (5 km/h), opening the driver's door will engage mode **P** - risk of sudden braking!

! In the event of battery failure, it is essential to place the chock(s) supplied with the tool kit against one of the wheels to immobilise the vehicle.

Special aspects of automatic mode

The gearbox selects the gear that provides optimal performance based on ambient temperature, road profile, vehicle loading and driving style.

For maximum acceleration, press the accelerator fully down (kick-down). The gearbox changes down automatically or holds the selected gear until the maximum engine speed is reached. Steering mounted controls allow the driver to temporarily select a gear, if the vehicle speed and engine speed conditions permit.

Special aspects of manual mode

The gearbox only changes from one gear to another if the vehicle speed and engine speed conditions permit.

Starting the vehicle

- Fully depress the brake pedal.
 - Start the engine.
 - With your foot on the brake pedal, push once or twice backwards to select automatic mode **D**, or forwards to shift into reverse gear **R**.
 - Release the brake pedal.
 - Accelerate gradually to automatically release the electric parking brake.
- The vehicle moves off immediately.

! **Automatic gearbox**
Never try to start the engine by pushing the vehicle.

Switching the vehicle off

Regardless of the current gearbox mode, mode **P** is immediately engaged automatically when the ignition is switched off.

However, in mode **N**, mode **P** will be engaged after a delay of 5 seconds (time to enable free-wheeling mode).

Check that mode **P** has been engaged and that the electric parking brake was applied automatically; if not, apply it manually.



The corresponding indicator lamps on the gear selector and the electric parking brake control must be on, as well as the indicator lamps on the instrument panel.

Gearbox malfunction



This warning lamp comes on, accompanied by an audible signal and the display of a message.

Go to a PEUGEOT dealer or a qualified workshop.

Do not drive faster than 62 mph (100 km/h), keeping to the speed limit.

Switching of the gearbox to back-up mode

Mode **D** locks in third gear.

The paddles on the steering wheel do not work and mode **M** is no longer accessible.

You may feel a significant jolt on engaging reverse gear. This will not damage the gearbox.

Selector malfunction

Minor malfunction



This warning lamp comes on, accompanied by the display of a message and an audible signal.

Drive carefully.

Go to a PEUGEOT dealer or a qualified workshop.

In some cases, the selector indicator lamps may no longer come on, but the gearbox state is still displayed on the instrument panel.

Major malfunction



This warning lamp comes on, accompanied by the display of a message.

! You must stop the vehicle.

Stop as soon as it is safe to do so and switch off the ignition.

Contact a PEUGEOT dealer or a qualified workshop.

Drive selector (Electric)

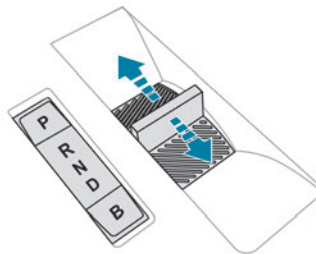

The drive selector is a pulse selector with a regenerative braking function.

The drive selector provides traction control based on the driving style, the road profile and the vehicle load.

With regenerative braking activated, it also manages engine braking when the accelerator pedal is released.

P. Park

Button for parking the vehicle: the front wheels are locked (the button lights up to indicate that it is activated).

R. Reverse

To engage reverse gear, with your foot on the brake pedal.

N. Neutral

To move the vehicle with the ignition off and so allow it to free-wheel.

For more information on **Free-wheeling**, refer to the corresponding section.

D. Drive (automatic forward gear)

B. Brake (regenerative braking)

Regenerative braking (the button lights up to indicate its activation).

Information displayed on the instrument panel

When the ignition is switched on, the drive selector status is displayed on the instrument panel:

P : Park.

R : Reverse.

N : Neutral.

D : Drive (automatic forward gear).

B : Brake (regenerative braking activated).

Operation

- ▶ In mode **N**, with your foot on the brake pedal, push without passing the point of resistance:
 - Forwards, mode **R** is selected.
 - Backwards, mode **D** is selected.

Release the selector fully after each push; it will then return to its initial position.

Special cases

To avoid mode **N** (quick change from **D** to **R** and back again):

- ▶ In mode **R**, push backwards past the point of resistance, mode **D** is selected.
- ▶ In mode **D**, push forwards past the point of resistance, mode **R** is selected.
- ▶ To return to mode **N**, push without passing the point of resistance.

Regenerative braking

With the Brake function and when decelerating

The Brake function emulates engine braking, slowing the vehicle with no need to depress the brake pedal. The vehicle slows more quickly when the driver releases the accelerator pedal. The energy recovered when the accelerator pedal is released is then used to partially recharge the traction battery, thereby increasing the vehicle's driving range.

! The resulting deceleration of the vehicle does not cause the brake lamps to come on.

- ▶ From mode **D/B**, move the push selector backwards to activate/deactivate the function. **D** on the instrument panel is replaced with **B**. The system status is not saved when the ignition is switched off.

! In some situations (e.g. battery full, extreme temperatures), the amount of regenerative braking may be temporarily limited, resulting in less deceleration. The driver must remain alert to traffic conditions and must always be ready to use the brake pedal.

With the brake pedal

When the brake pedal is depressed, the intelligent braking system automatically recovers some of the energy and uses it to recharge the traction battery.

This energy recovery also reduces use of the brake pads, thereby limiting their wear.

i The driver may experience a different sensation when depressing the brake pedal compared to a vehicle without regenerative braking.

Driving modes

The driving modes available depend on the engine and equipment of the vehicle. Driving modes are selected using the following control:

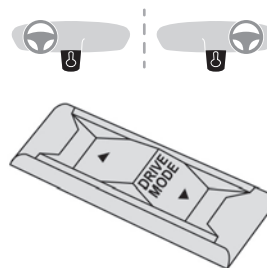

- ▶ Press the control to display the modes on the instrument panel.

With an electric vehicle, when starting the vehicle, no mode can be selected until the **READY** indicator lamp is displayed.

When the message disappears, the selected mode is activated and remains indicated on the instrument panel (except **Normal** mode).

With the Advanced Grip Control system, additional driving modes are available.

For more information on **Advanced Grip Control**, refer to the corresponding section.

For petrol/Diesel versions

Whenever the ignition is switched on, **Normal** driving mode is selected by default.

Normal

To restore the default settings.

Eco

To reduce energy consumption by reducing the performance of the heating and air conditioning, without deactivating them.

To reduce consumption of the traction battery's electrical energy by limiting engine torque.

Sport

With a manual gearbox: to obtain more dynamic driving with action on the power steering, accelerator and the possibility of displaying the vehicle's dynamic settings on the instrument panel.

With an automatic gearbox: to obtain more dynamic driving with action on the power steering, accelerator, gear changes and possibility of displaying the vehicle's dynamic settings on the instrument panel.

The selection of the Sport mode deactivates the Stop & Start function.

Manual

Permanent **Manual** mode with an automatic gearbox.

This manual mode is accessed via the button **M** of the push selector.

To change gears manually using the control paddles on the steering wheel.

For more information on **Automatic gearbox (EAT8)**, refer to the corresponding section.

Coasting mode

Depending on version or engine, with an EAT8 gearbox and the gear selector in mode **D**, except in **Sport** mode, gradually and fully releasing the accelerator pedal allows free-wheeling which can save fuel.

A drop in engine speed is normal (rev counter at idle, drop in engine noise).

For electric versions

Each time the ignition is switched on, **Normal** mode is selected by default.

Normal

This optimises the driving range and dynamic performance.

To obtain maximum torque and power, depress the accelerator pedal fully.

Eco

Optimises energy consumption, by reducing the output of the heating and air conditioning (without actually deactivating them) and limiting both motor torque and power.

Sport

Enables more dynamic driving, acting on the power steering, accelerator and gear changes with a drive selector and the possibility of displaying the vehicle's dynamic settings on the instrument panel.

Hill start assist

This system keeps the vehicle briefly stationary (for approximately 2 seconds) when making a hill start, while you transfer your foot from the brake pedal to the accelerator pedal.

The system is only active when:

- The vehicle is completely stationary, with your foot on the brake pedal.
- Certain slope conditions are met.
- The driver's door is closed.

 Do not leave the vehicle while it is being held temporarily by hill start assist.

If someone needs to get out of the vehicle with the engine running, apply the parking brake manually. Then check that the parking brake indicator lamp and the **P** indicator lamp in the electric parking brake control are on fixed.

 The hill start assist function cannot be deactivated. However, using the parking brake to immobilise the vehicle interrupts its operation.

Operation

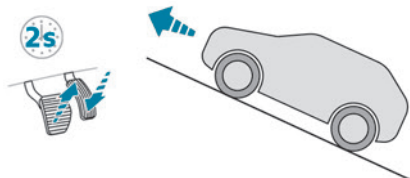

Facing uphill, with the vehicle stationary, the vehicle is held for a short time when the driver releases the brake pedal:

- If first gear or neutral is engaged on a manual gearbox.
- If mode **D** or **M** is selected on an automatic gearbox.
- If mode **D** or **B** is selected on the drive selector.

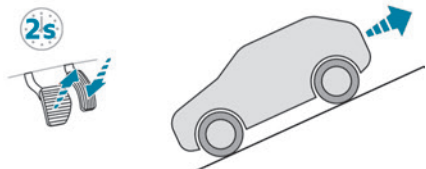

Facing downhill, with the vehicle stationary and reverse gear engaged, the vehicle is held for a short time when the driver releases the brake pedal.

Malfunction



If the event of a malfunction, these warning lamps light up on the

instrument panel, accompanied by the display of a message.

Have it checked by a PEUGEOT dealer or a qualified workshop.

Gear shift indicator

This system is designed to reduce fuel consumption by recommending the most suitable gear.

Operation

Depending on the driving situation and the vehicle's equipment, the system may recommend skipping one or more gears. Gear engagement recommendations are not to be considered mandatory. Indeed, the configuration of the road, the traffic density and safety remain determining factors when choosing the best gear. Therefore, the driver remains responsible for deciding whether or not to follow the system's advice.

The system cannot be deactivated.

i With an automatic gearbox, the system is only active in manual operation.

4 The information appears on the instrument panel, in the form of an arrow and the recommended gear.

i The system adapts the gear change instructions according to the driving

conditions (e.g. slope, load) and driving style (e.g. power demand, acceleration, braking).

The system never suggests:

- engaging first gear.
- engaging reverse gear.

Stop & Start

The Stop & Start function puts the engine temporarily into standby - STOP mode - during phases when the vehicle is stationary (e.g. red lights, traffic jams). The engine automatically restarts - START mode - as soon as the driver indicates the intention of moving off again. Primarily designed for urban use, the function is intended to reduce fuel consumption and exhaust emissions as well as the noise level when stationary.

The function does not affect the functionalities of the vehicle, in particular the braking.

Deactivation/Reactivation

By default, the function is activated when the ignition is switched on.

With Touch screen 10" & Bluetooth Radio & Telephone



The settings are changed via the **Driving** touch screen menu.

With PEUGEOT i-Connect Advanced - PEUGEOT i-Connect



The settings are changed via the **ADAS** touch screen application or via the

Shortcuts for driving aids.

The display of a message on the instrument panel confirms the change of state.

If the function is deactivated while the engine is in STOP mode, it will restart immediately.

Associated indicator lamps



Function activated: engine on standby (STOP mode)



Function deactivated or malfunction

! Opening the bonnet

Before doing anything under the bonnet, deactivate the Stop & Start system to avoid any risk of injury caused by the engine restarting automatically.



! Driving on flooded roads

Before entering into a flooded area, it is strongly recommended that you deactivate the Stop & Start system.

For more information on **Driving recommendations**, particularly on flooded roads, refer to the corresponding section.

Operation

Main conditions for operation

- The driver's door must be closed.
- The driver's seat belt must be fastened.
- The level of charge in the battery must be sufficient.
- The temperature of the engine must be within its nominal operating range.
- The outside temperature must be between 0°C and 35°C.

Putting the engine into standby (STOP mode)

The engine automatically enters standby mode as soon as the driver indicates their intention to stop:

- **With a manual gearbox:** when you place the gear lever in neutral and release the clutch pedal.
- **With an automatic gearbox:** with the gear selector in mode **D** or **M**, when the brake pedal is depressed until the vehicle stops or when the mode **N** is selected, with the vehicle stationary.

Time counter

A time counter adds up the time spent in standby during the journey. It is reset to zero every time the ignition is switched on.

Special cases

The engine will not go into standby if the conditions for operation are not met and in the following cases:

- Steep slope (ascending or descending).
- Vehicle has not exceeded 6 mph (10 km/h) since the last engine start (with the key or the **START/STOP** button).
- Sport mode selected (depending on equipment).
- Needed to maintain a comfortable temperature in the passenger compartment.
- Demisting active.



In these cases, this indicator lamp flashes for a few seconds, then goes off.

i After the engine has restarted, STOP mode is not available until the vehicle has reached a speed of 5 mph (8 km/h).

i During parking manoeuvres, STOP mode is not available for a few seconds after coming out of reverse gear or turning the steering wheel.

Restarting the engine (START mode)

The engine automatically restarts as soon as the driver indicates the intention of moving off again:

With a manual gearbox: when the clutch pedal is fully depressed.

With an automatic gearbox:

- With the selector in mode **D** or **M**: when the brake pedal is released.
- With the selector in mode **N** and the brake pedal released: when the mode **D** or **M** is selected.
- With the selector in mode **P** and the brake pedal depressed: when the mode **R**, **N**, **D** or **M** is selected.
- When the reverse gear is engaged.

Special cases

The engine will restart automatically if the conditions for operation are met again and in the following cases:

- Deselecting the Sport mode (depending on equipment).
- With a manual gearbox: vehicle speed exceeds 2.5 mph (4 km/h).
- With an automatic gearbox, in mode **N**, vehicle speed exceeds 0.6 mph (1 km/h).



In these cases, this indicator lamp flashes for a few seconds, then goes off.

Malfunctions



In the event of a fault with the system, this warning lamp flashes for a few moments on the instrument panel, then remains on, accompanied by the display of a message. Have it checked by a PEUGEOT dealer or a qualified workshop.

The vehicle stalls in STOP mode

All of the instrument panel warning lamps come on if there is a fault.

► Switch off the ignition then start the engine again with the key or the "START/STOP" button.

! 12 V battery

The Stop & Start system requires a 12 V battery of specific technology and specification.

All work must be carried out only by a PEUGEOT dealer or a qualified workshop.

Tyre under-inflation detection

This system alerts the driver if one or more tyres suffer a drop in pressure.

The alert is raised when the vehicle is moving, not when stationary.

It compares the information given by the wheel speed sensors with **reference values, which must be reinitialised every time the tyre pressures are adjusted or a wheel changed.**

It takes into account the last values stored during the reinitialisation request. It is therefore essential that the tyre pressure is correct during the operation. This operation is the driver's responsibility.

! The tyre under-inflation detection cannot, in any circumstances, replace the need for vigilance on the part of the driver. This system does not avoid the need to regularly check the tyre pressures (including the spare wheel), especially before a long journey.

Driving with under-inflated tyres, particularly in adverse conditions (heavy load, high speed, long journey):

- worsens road-holding.
- lengthens braking distances.
- causes premature wear of the tyres.
- increases energy consumption.

i The inflation pressures defined for the vehicle can be found on the tyre pressure label.

For more information on the **Identification markings**, refer to the corresponding section.

! Checking tyre pressures

This check should be done monthly when the tyres are "cold" (vehicle stopped for 1 hour or after a journey of less than 6 miles (10 km) at moderate speeds). Otherwise, add 0.3 bar to the pressures shown on the label.

Snow chains

The system does not have to be reinitialised after fitting or removing snow chains.

Under-inflation alert



This is signalled by the fixed illumination of this warning lamp, accompanied by an audible signal and, depending on equipment, the display of a message.

- ▶ Reduce speed immediately, avoid excessive steering movements and avoid sudden braking.
- ▶ Stop the vehicle as soon as it is safe to do so.

 The loss of pressure detected may not always cause visible deformation of the tyre.
Do not rely on just a visual check.

- ▶ Using a compressor, such as the one in the temporary puncture repair kit, check the pressures of all four tyres when cold.
- ▶ If it is not possible to carry out this check immediately, drive carefully at reduced speed.
- ▶ In the event of a puncture, use the temporary puncture repair kit or the spare wheel (depending on equipment).

 Driving too slowly may not ensure optimum monitoring.
The alert is not immediately triggered in the event of a sudden loss of pressure or tyre

blow-out. This is because analysis of the values read by the wheel's speed sensors can take several minutes.
The alert may be delayed at speeds below 25 mph (40 km/h), or when adopting a sporty driving mode.

 The alert is kept active until the system is reinitialised.

Reinitialisation

The system must be reinitialised after any adjustment to the pressure of one or more tyres, and after changing one or more wheels.

 Before reinitialising the system, make sure that the pressures of the four tyres are correct for the conditions of use of the vehicle and conform to the values written on the tyre pressure label.
Check the pressures of the four tyres before performing the reinitialisation.
The system does not advise if a pressure is incorrect at the time of reinitialisation.

With Touch screen 10" & Bluetooth Radio & Telephone



With the vehicle stationary, the system can be reinitialised via the **Driving** touch screen menu.

With PEUGEOT i-Connect Advanced - PEUGEOT i-Connect



With the vehicle stationary, the system can be reinitialised in the

Settings>Vehicle touch screen application.

- ▶ Then select **Safety > Tire Pressure Setup**.
- ▶ Press **YES** to confirm.

The reinitialisation is confirmed by the display of a message and an audible signal.

Malfunction



In the event of a malfunction, these warning lamps light up on the instrument panel.

A message appears, accompanied by an audible signal.

In this case, the tyre under-inflation monitoring function is no longer performed.

Have it checked by a PEUGEOT dealer or a qualified workshop.

Non-standard or 'space-saver' spare wheel

The use of this type of spare wheel may suspend tyre pressure monitoring.

In this case, the malfunction warning lamp comes on and disappears once the wheel has been replaced by one of uniform size (the same as the others), the pressure readjusted and the reinitialisation carried out.

Driving and manoeuvring aids - General recommendations

i Driving and manoeuvring aids cannot, in any circumstances, replace the need for vigilance on the part of the driver. The driver must comply with the Highway Code, must remain in control of the vehicle in all circumstances and must be able to retake control of it at all times. The driver must adapt the speed to climatic conditions, traffic and the state of the road. It is the driver's responsibility to constantly monitor traffic conditions, assess the distance and relative speed of other vehicles, and anticipate their manoeuvres before using the direction indicator and changing lanes. These systems do not make it possible to exceed the laws of physics.

i **Driving aids**
You should hold the steering wheel with both hands, always use the door and interior mirrors, always leave your feet close to the pedals and take a break every 2 hours.

i **Manoeuvring aids**
The driver must always check the surroundings of the vehicle before and during

the whole manoeuvre, in particular using the mirrors.

! **Radar(s)**
The operation of the radar(s), along with any associated functions, may be affected by the accumulation of dirt (e.g. mud, ice), in poor weather conditions (e.g. heavy rain, snow), by the masking of the detection zone with adhesive labels or other objects, or if the bumpers are damaged. If the front or rear bumper is to be repainted, contact a PEUGEOT dealer or a qualified workshop; certain types of paint could interfere with the operation of the radar(s). Take care not to cover the detection zones on the front and rear bumpers with adhesive labels or other objects; they may hamper correct operation of the associated system.



! **Driving aids camera**
This camera and its associated functions may be impaired or not work if the windscreen area in front of the camera is dirty, misty, frosty, covered with snow, damaged or masked by a sticker. In humid and cold weather, demist the windscreen regularly.

Poor visibility (e.g. inadequate street lighting, heavy rain, thick fog, snowfall), dazzle (e.g. headlamps of an oncoming vehicle, low sun, reflections on a damp road, leaving a tunnel, alternating shade and light) can also impair detection performance. In the event of a windscreen replacement, contact a PEUGEOT dealer or a qualified workshop to recalibrate the camera; otherwise, the operation of the associated driving aids may be disrupted.

i **Other cameras**
The images from the camera(s) displayed on the touch screen or on the instrument panel may be distorted by the terrain. In the presence of areas in shade, or in conditions of bright sunlight or inadequate lighting, the image may be darkened and with lower contrast. Obstacles may appear further away than they actually are.

! **Sensors**
The operation of the sensors, as well as any associated functions, may be disrupted by noise pollution such as that emitted by noisy vehicles and machinery (e.g. lorries, pneumatic drills), by the accumulation of snow or dead leaves on the road or in the event of damaged bumpers and mirrors.

When reverse gear is engaged, an audible signal (long beep) indicates that the sensors may be dirty.

A front or rear impact to the vehicle can upset the sensors' settings, which is not always detected by the system: distance measurements may be distorted. The sensors do not systematically detect obstacles that are too low (pavements, studs) or too thin (trees, posts, wire fences). Certain obstacles located in the sensors' blind spots may not be detected or may no longer be detected during the manoeuvre. Certain materials (fabrics) absorb sound waves: pedestrians may not be detected.

i Maintenance

Clean the bumpers and door mirrors and the field of vision of the cameras regularly. When washing your vehicle at high pressure, direct the spray from at least 30 cm away from the radar, sensors and cameras.

! Mats/Pedal trims

The use of mats or pedal trims not approved by PEUGEOT may interfere with the operation of the speed limiter or cruise control.

To avoid any risk of jamming the pedals:

- Ensure that the mat is secured correctly.
- Never fit one mat on top of another.

i Units of speed

Ensure that the units of speed displayed on the instrument panel (mph or km/h) are those for the country you are driving in. If this is not the case, when the vehicle is stationary, set the display to the required units of speed so that it complies with what is authorised locally. In case of doubt, contact a PEUGEOT dealer or a qualified workshop.

Shortcuts for driving aids

With PEUGEOT i-Connect Advanced - PEUGEOT i-Connect

The full list of available driving aids can be found in the **Functions** tab.

Driving aids can be accessed directly to quickly activate/deactivate them.

By default, driving aids are already stored in the **Shortcuts** tab (e.g. Stop & Start, Lane keeping assist).

Other driving aids can be added or deleted from this tab.



It is configured in the **ADAS>Functions** touch screen application.



▶ Press the button corresponding to the driving assistance concerned:

- Full symbol: the function is added to the **Shortcuts** tab.
- Empty symbol: the function is deleted from the **Shortcuts** tab.

- ▶ Check the modification in the **Shortcuts** tab.

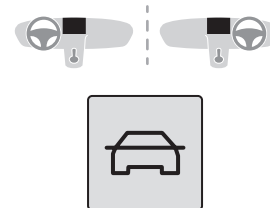

- ▶ Press this button to access directly to the **Shortcuts** tab.

Multiple deactivation

It is possible to deactivate several driver assistance functions simultaneously.

This is done in two steps:

- First of all, the selection of all the functions that you want to deactivate.
- Secondly, the simultaneous deactivation of all these functions.

Selection of functions



▶ Press this button on the dashboard to display the **ADAS** tabs.

- ▶ Select the **Functions** tab.



▶ Press this button to display the list of available functions.

- ▶ Select the functions to deactivate (e.g. Stop&Start, Lane Keeping Assist, Automatic Braking System (Active Safety Brake)).



▶ Press this button to return to the previous page.

The functions to deactivate are saved in the system.

Deactivation of these functions



▶ Press and hold this button on the dashboard.

All previously selected functions are deactivated until the vehicle is next restarted (confirmed by an audible signal).

Road signs recognition

! For more information, refer to the **General recommendations on the use of driving and manoeuvring aids.**



This system displays the maximum speed authorised locally on the instrument panel, using:



- Speed limit signs detected by the camera.
- Speed limit information from the on-board navigation system's mapping.
- Speed limit information from the connected services.

– Signs indicating a shared traffic zone detected by the camera.

Sign detected	Suggested speed (calculated)
Entry into a shared traffic zone Example: 	Without PEUGEOT i-Connect Advanced 10 mph or 20 km/h (depending on the units on the instrument panel) With PEUGEOT i-Connect Advanced Display of the speed in force in the country you are driving in.

– Some supplementary traffic signs detected by the camera.

Supplementary traffic sign detected	Display of the speed associated with the supplementary traffic sign
Speed limit when raining Examples: 	If the wiper control stalk is in the "intermittent wipe" or "automatic wipe" position (in order to activate the rain sensor): 68 mph (110 km/h) (for example)
Speed limit when towing 	If an approved towing device is fixed to the vehicle: 56 mph (90 km/h) (for example)
Speed limit applicable over a certain distance Example: 	43 mph (70 km/h) (for example)

Supplementary traffic sign detected	Display of the speed associated with the supplementary traffic sign
<p>Speed limit for vehicles with a gross vehicle weight or gross train weight less than 3.5 tonnes</p> 	56 mph (90 km/h) (for example)
<p>Speed limit in case of snow Example:</p> 	<p>If the outside temperature is below 3°C: 19 mph (30 km/h) (for example) with a "snowflake" symbol</p>
<p>Speed limit at certain times of the day Example:</p> 	19 mph (30 km/h) (for example) with a "clock" symbol

i To get valid speed limit information, the vehicle's current position is sent via the

telematics unit and is immediately deleted after processing.
Tracking of the vehicle position is not possible at any time.
This is not impacted by the privacy settings of the connected services.

! On-board navigation mapping should be regularly updated in order to receive accurate speed limit information from the system.

! The units for the speed limit (mph or km/h) depend on the country you are driving in.
This should be taken into account to ensure you observe the speed limit.
For the system to work properly when changing countries, the speed unit of the instrument panel must match that of the country you are driving in.
Country selection is only available for audio systems without on-board navigation.

! Automatic sign reading is a driving aid system and does not always display the correct speed limits.
The speed limit signs present on the road always take priority over those displayed by the system.

The system is designed to detect signs that conform to the Vienna Convention on road signs.

i Specific speed limits, such as those for heavy goods vehicles, are not displayed.
The display of the speed limit on the instrument panel is updated when passing a speed limit sign intended for cars (light vehicles).

Information displayed on the instrument panel



1. Detected speed limit indication
or
2. End of speed limit indication (depending on version)



The system is active but is not detecting speed limit information.



On detecting speed limit information, the system displays the value, accompanied by an audible signal.



For a suggested maximum speed, when the vehicle exceeds it, the speed is displayed and flashes for 3 seconds.



If the vehicle continues to exceed it, the speed is displayed and flashes for 8 seconds, accompanied by an audible signal.

Operating limits

The system does not take account of reduced speed limits, especially those imposed in the following cases:

- Atmospheric pollution.
- Towing.
- Driving with a space-saver type spare wheel or snow chains fitted.

- Tyre repaired using the temporary puncture repair kit.
 - Young drivers.
- The system may not display the speed limit if it does not detect a speed limit sign within a preset period and in the following situations:
- Road signs that are obstructed, non-standard, damaged or bent.

Settings

Deactivation/Activation

By default, the overspeed alert sound is automatically activated at every engine start.



You can activate/deactivate the overspeed alert and the speed limit change sound.

or

Direct access to the **Shortcuts for driving aids**.



The system cannot be deactivated. The speed limit change sound is saved when the ignition is switched off.



In the event of the overspeed alert sound deactivation, this warning lamp lights up a few seconds on the instrument panel.

Country selection

The list of detected road signs can be updated by selecting a specific country.

With Touch screen 10" & Bluetooth Radio & Telephone



► The desired country can be selected via the **Driving** touch screen menu.

With PEUGEOT i-Connect Advanced - PEUGEOT i-Connect



► In the **ADAS** touch screen application, select **Functions>Road Signs>Country setting**.

► In the **Select Country** list, select the desired country.

i The current country is displayed under the function name in the settings screen. The country selection is saved when the ignition is switched off.

Malfunction



In the event of a malfunction, this warning lamp lights up on the instrument panel, accompanied by the display of a message and an audible signal.

Have it checked by a PEUGEOT dealer or a qualified workshop.



This warning lamp lights up on the instrument panel with the message **"Driving Assistance Sensor blind: Clean sensor, see User Manual"** if the sensor is masked.

This is a normal behavior, which does not request the support of a qualified workshop.

In this case, stop the vehicle and verify if the front camera is covered by dirt, mud, sand, snow, ice or anything preventing the sensing. The system is operational again after the detection field has been cleaned.

Recommendation



In addition to **Road signs recognition**, the driver can select the speed displayed as a speed setting for the speed limiter or cruise control using the speed limiter or cruise control 'store' button.

If rain is detected, the system will suggest to the driver a speed setting lower than the speed read/obtained from the mapping system in order to best suit the weather conditions (e.g. on a motorway, the suggested speed will be 68 mph (110 km/h) instead of 81 mph (130 km/h)).

i For more information on the **Speed limiter, Cruise control or Adaptive cruise control**, refer to the corresponding sections.

Steering-mounted controls

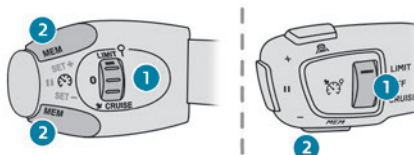

1. Speed limiter/cruise control mode selection
2. Memorise the speed setting

Information displayed on the instrument panel



3. Speed limit indication
4. Speed memorisation prompt
5. Current speed setting

Storing the speed setting



- Switch on the speed limiter/cruise control. The speed limiter/cruise control information is displayed. Upon detecting a sign suggesting a new speed setting, the system displays the value and

"MEM" flashes for a few seconds, prompting you to save it as a new speed setting.

i If there is a difference of less than 6 mph (9 km/h) between the speed setting and the speed displayed by the Road signs recognition, the "MEM" symbol is not displayed.

Depending on the road conditions, several speeds may be displayed.

- Press button **2** **once** to save the suggested speed value.

A message is displayed, confirming the request.

- Press button **2** **again** to confirm and save the new speed setting.

The display then reverts to its previous state.

Extended Traffic Sign Recognition

(Depending on version)

! For more information, refer to the **General recommendations on the use of driving and manoeuvring aids**.



This additional system recognises these road signs and displays them on the instrument panel.

As you approach it, the symbol of the corresponding sign is displayed on the instrument panel.

! The actual road signs always take priority over those displayed by the system. The signs must comply with the Vienna Convention on road signs.

Activation/Deactivation

With Touch screen 10" & Bluetooth Radio & Telephone



The settings are changed via the **Driving** touch screen menu.

With PEUGEOT i-Connect Advanced - PEUGEOT i-Connect



The settings are changed via the **ADAS** touch screen application.

Speed limiter

! For more information, refer to the **General recommendations on the use of driving and manoeuvring aids.**



This system prevents the vehicle from exceeding the speed programmed by the driver (speed setting).

The speed limiter is switched on manually.

The minimum speed setting is 19 mph (30 km/h).

The speed setting remains in the system memory when the ignition is switched off.

Steering-mounted control

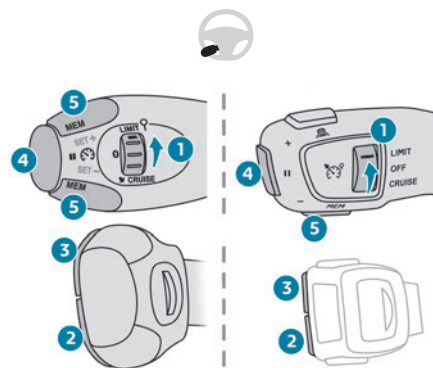

1. ON (**LIMIT** position)/OFF
2. Reduce the speed setting
3. Increase the speed setting
4. Pause/resume speed limiter with the speed setting previously stored
5. Use the speed suggested by the Road signs recognition function (**MEM** display)

For more information on the **Road signs recognition**, refer to the corresponding section.

Information displayed on the instrument panel

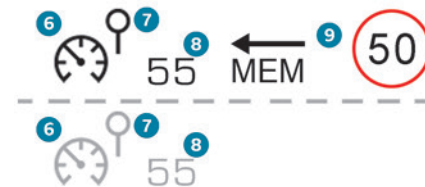

6. Speed limiter on/pause status indication
7. Speed limiter mode selection indication
8. Speed setting value
9. Speed suggested by the Road signs recognition function (depending on version)

Switching on/Pausing

- ▶ Turn thumbwheel **1** to the "**LIMIT**" position to select speed limiter mode; the function is paused.
- ▶ If the speed limit setting is suitable (most recent speed setting programmed in the system), press button **4-II** to switch the speed limiter on.
- ▶ Pressing **4-II** again temporarily pauses the function (pause).

i When the speed setting remains below the vehicle's speed for a prolonged period of time, an audible warning is emitted.

Adjusting the limit speed setting

You do not have to switch the speed limiter on in order to set the speed.

To modify the limit speed setting based on the vehicle's current speed:

- ▶ For steps of +/- 1 mph (1 km/h), briefly press **2-SET-** or **3-SET+** repeatedly.
- ▶ For steps of +/- 5 mph (5 km/h), press and hold **2-SET-** or **3-SET+**.

To modify the speed limit setting based on the speed suggested by the Road signs recognition function displayed on the instrument panel:

- ▶ Press **5-MEM** once; a message is displayed, confirming the memorisation request.
- ▶ Press **5-MEM** again to save the suggested speed.

The new speed setting value is displayed on the instrument panel.

Temporarily exceeding the speed setting

- ▶ Fully depress the accelerator pedal.

The speed limiter is temporarily deactivated and the displayed speed setting flashes.

- ▶ Release the accelerator pedal to return to below the speed setting.

When exceeding the speed is not due to the driver's action (e.g. in case of a steep slope), an audible signal is triggered immediately.

! On a steep descent or in the event of sharp acceleration, the speed limiter will not be able to prevent the vehicle from exceeding the speed setting. If necessary, apply the brakes to control your vehicle's speed.

When the vehicle speed returns to the speed setting level, the speed limiter operates again: the speed setting display becomes fixed again.

Switching off

- ▶ Turn the thumbwheel **1** to the "OFF" position: speed limiter information is no longer displayed.

Malfunction

In the event of a malfunction, dashes are displayed flashing and then fixed instead of the speed setting.

Have it checked by a PEUGEOT dealer or a qualified workshop.

Cruise control - Specific recommendations

! The cruise control function does not guarantee compliance with the maximum authorised speed and the safety distance between vehicles, the driver remains responsible for their driving. In the interest of public safety, only use cruise control if the traffic conditions enable vehicles

to drive at a steady speed and maintain an adequate safety distance.

Remain vigilant while cruise control is activated. If you press and hold one of the speed setting modification buttons, your vehicle may change speed very abruptly. When **descending a steep hill**, the cruise control system cannot prevent the vehicle from exceeding the set speed. Brake if necessary to control the vehicle speed. On **steep climbs** or when towing, the set speed may not be reached or maintained.

i Exceeding the programmed speed setting

You can **temporarily** exceed the speed setting by pressing the accelerator pedal (the programmed speed flashes).

To return to the speed setting, release the accelerator pedal (when the set speed is reached again, the displayed speed stops flashing).

! Operating limits

Never use the system in the following situations:

- In an urban area with the risk of pedestrians crossing the road.
- In heavy traffic (except versions with the Stop & Go function).
- On winding or steep roads.
- On slippery or flooded roads.

- In poor weather conditions.
- In the event of restricted visibility for the driver.
- Driving on a speed circuit.
- Driving on a rolling road.
- When using a 'space-saver' type spare wheel.
- When using snow chains or non-slip covers.

i Cruise control remains active after changing gear, regardless of the gearbox type, on engines fitted with the Stop & Start function.

i Switching off the ignition cancels any speed setting.

Steering-mounted control

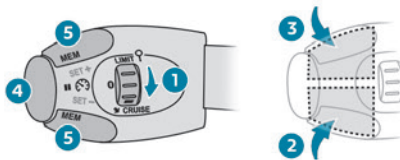

1. ON (**CRUISE** position)/OFF
2. Activate cruise control at the current speed/ decrease speed setting
3. Activate cruise control at the current speed/ increase speed setting
4. Pause/resume cruise control with the speed setting previously saved
5. Use the speed suggested by the Road signs recognition function (**MEM** display)

For more information on the **Road signs recognition**, refer to the corresponding section.

Information displayed on the instrument panel

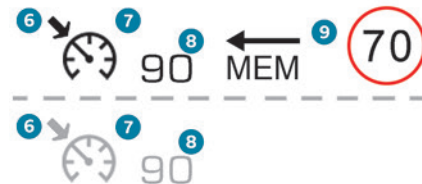

6. Cruise control pause/resume
7. Cruise control mode selection
8. Speed setting value
9. Speed suggested by the Road signs recognition function (depending on version)

Switching on/pausing

- ▶ Turn thumbwheel **1** to the "**CRUISE**" position to select cruise control mode; the function is paused.
- ▶ Press button **2-SET-** or **3-SET+** to activate cruise control and save a speed setting when the vehicle has reached the desired speed; the vehicle's current speed is saved as the speed setting.
- ▶ Release the accelerator pedal.
- ▶ Pressing button **4-II** temporarily pauses the function (pause).
- ▶ Pressing button **4-II** again resumes operation of the cruise control (ON).

Cruise control

! For more information, refer to the **General recommendations on the use of driving and manoeuvring aids** and the **Specific recommendations on cruise control**.



This system automatically maintains the vehicle's speed at the value programmed by the driver (speed setting), without the use of the accelerator pedal.

Cruise control is switched on manually.

It requires a minimum vehicle speed of 25 mph (40 km/h).

With a manual gearbox, third gear or higher must be engaged.

With an automatic gearbox, mode **D** or second gear or higher in mode **M** must be engaged.

With a drive selector, mode **D** or **B** must be engaged.

i Cruise control can also be paused temporarily:

- by pressing the brake pedal.
- automatically, if the electronic stability control (ESC) system is triggered.

Changing the cruise speed setting

The cruise control must be active.

To change the cruise speed setting, based on the vehicle's current speed:

- ▶ For steps of +/- 1 mph (1 km/h), briefly press **2-SET-** or **3-SET+** repeatedly.
- ▶ For steps of +/- 5 mph (5 km/h), press and hold **2-SET-** or **3-SET+**.

! Pressing and holding **2-SET-** or **3-SET+** results in a rapid change in the speed of the vehicle.

! As a precaution, we recommend setting a cruise speed fairly close to the current speed of your vehicle, to avoid any sudden acceleration or deceleration of the vehicle.

To change the cruise speed setting using the speed suggested by the Road signs recognition function displayed on the instrument panel:

- ▶ Press **5-MEM** once; a message is displayed, confirming the memorisation request.
- ▶ Press **5-MEM** again to save the suggested speed.

The new speed setting value is displayed on the instrument panel.

Switching off

▶ Turn the thumbwheel 1 to the "**OFF**" position: the cruise control information disappears from the screen.

Malfunction

In the event of a malfunction, dashes are displayed flashing and then fixed instead of the speed setting.

Have it checked by a PEUGEOT dealer or a qualified workshop.

Drive Assist Plus

Only available on versions with the EAT8 automatic gearbox and drive selector.

This system automatically adjusts the speed and corrects the trajectory of the vehicle, using Adaptive cruise control with Stop&Go function in conjunction with Lane positioning assist. These two functions must be activated and in operation.

For more information on **Adaptive cruise control** and **Lane positioning assist**, refer to the corresponding sections.

! The system assists the driver by acting on the steering, acceleration and braking within the physical limits and capacities of the vehicle. Certain road infrastructure elements

or vehicles in the surroundings may not be properly seen or may be poorly interpreted by the camera and radar, resulting in an unexpected change in direction, a lack of steering correction and/or inappropriate management of acceleration or braking.

! Primarily designed for driving on main roads and motorways, this system only works with moving vehicles driving in the same direction as your vehicle.

Adaptive cruise control

! For more information, refer to the **General recommendations on the use of driving and manoeuvring aids** and the **Specific recommendations on cruise control**.

This system automatically maintains the vehicle speed at a value set by the driver (speed setting), while respecting a safety distance from the vehicle in front (target vehicle) previously set by the driver. The system automatically manages the acceleration and deceleration of the vehicle. With a manual gearbox, the system slows the vehicle down as far as a speed of 19 mph (30 km/h). With the **Stop & Go function**, the system manages braking until the vehicle comes to a complete stop and restarts the vehicle.

! The brake lamps come on if the vehicle is slowed down by the system.

It can be dangerous to drive if the brake lamps are not in perfect working order.



To do this, the system uses a camera fitted at the top of the windscreen and, depending on version, a radar fitted in the front bumper.

! Primarily designed for driving on main roads and motorways, this system only works with moving vehicles driving in the same direction as your vehicle.

i If the driver activates the direction indicator to overtake a slower vehicle, cruise control may temporarily reduce the distance to the target vehicle to facilitate overtaking, without exceeding the speed setting.

Steering-mounted controls

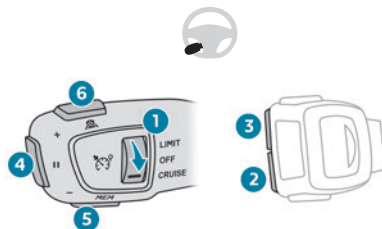

1. ON (**CRUISE** position)/OFF
2. Activation of cruise control at the current speed/decrease speed setting
3. Activation of cruise control at the current speed/increase speed setting
4. Pause/resume cruise control with the speed setting previously saved
Confirmation of vehicle restart after an automatic stop (for versions with Stop & Go function)
5. Use the speed suggested by the Road signs recognition function (**MEM** display)
6. Display and adjustment of the distance setting to the vehicle in front

Use

Activating the system (pause)

- ▶ With the engine running, turn thumbwheel **1** downwards to the **CRUISE** position. Cruise control is ready to operate (grey display).

Switching on cruise control and setting the speed

With a manual gearbox, your speed must be between 19 and 112 mph (30 and 180 km/h). With an EAT8 automatic gearbox or a drive selector, your speed must be between 0 and 112 mph (0 and 180 km/h).

- ▶ Press **2-SET-** or **3-SET+**: the current speed becomes the speed setting (minimum 19 mph (30 km/h)) and cruise control is immediately activated (green display).
- ▶ Press **3-SET+** to increase or **2-SET-** to decrease the speed setting (steps of 5 mph (km/h) if held pressed).

! Pressing and holding either **2-SET-** or **3-SET+** results in a rapid change in the speed of the vehicle.

Pausing/resumption of cruise control

- ▶ Press **4-II** or depress the **brake pedal** (grey display).
Cruise control may also have been paused:
 - automatically, if the electronic stability control (ESC) system is triggered.
 - by engaging neutral.
 - when the speed of the vehicle goes below 19 mph (30 km/h) with a manual gearbox.
 - when the speed of the engine goes below 1,100 rpm with a manual gearbox.
 - by depressing the clutch pedal for more than 10 seconds.
 - by using the electric parking brake.

- ▶ Press **4-II** to resume cruise control (green display).

With an EAT8 gearbox or a drive selector, following braking that has brought the vehicle to a complete stop, if the traffic conditions do not allow the vehicle to begin moving again within 3 seconds of stopping, press **4-II** or depress the accelerator pedal to move off.

If the driver takes no action after the vehicle has been stopped, the electric parking brake is applied automatically after about 5 minutes.

i Cruise control remains active after changing gear, regardless of the gearbox type.

! When the driver attempts to reactivate cruise control after the function has been paused, the message "**Activation refused, unsuitable conditions**" is displayed briefly if reactivation is not possible (safety conditions not met).

Changing the programmed speed setting with the Road signs recognition function

- ▶ Press **5-MEM** to accept the speed suggested by the system on the instrument panel, then press again to confirm.

! To prevent sudden acceleration or deceleration of the vehicle, select a speed setting relatively close to the vehicle's current speed.

Changing the inter-vehicle distance

- ▶ Press **6** to display the distance setting thresholds ("Distant", "Normal", "Close"), then press again to select a threshold. After a few seconds, the option is accepted and will be memorised when the ignition is switched off.

Temporarily exceeding the speed setting

- ▶ Press the accelerator pedal fully. Distance monitoring and cruise control are deactivated while acceleration is maintained. "Cruise control on hold" is displayed.

Deactivating the system

- ▶ Turn thumbwheel **1** upwards to the **OFF** position.

Information displayed on the instrument panel

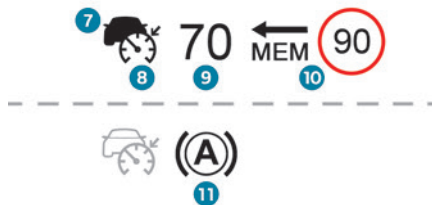

7. Vehicle detected by the system (full symbol)
8. Cruise control active (colour not grey)
9. Speed setting value







10. Speed suggested by the Road signs recognition function
11. Vehicle held stationary (versions with automatic gearbox or drive selector)



12. Inter-vehicle distance setting
13. Position of the vehicle detected by the system

Messages and alerts

i The actual order in which these messages or alerts are displayed may vary.

-  "**Cruise paused**" or "**Cruise control on hold**" following brief acceleration by the driver.
 -  "**Active cruise control**", no vehicle detected.
 -  "**Cruise paused**", vehicle detected.
 -  "**Active cruise control**", vehicle detected.
 -   (orange) "**Take back control**".
- ▶ Brake or accelerate, depending on the context.



(red)

"Take back control".

► **Take back control of the vehicle**

immediately: the system cannot manage the current driving situation.



"Activation refused, conditions unsuitable".

The system refuses to activate cruise control, as the necessary conditions are not fulfilled.

Stop & Go function



"To pick up again: accelerate or press the II button".

The system has brought the vehicle to a complete stop.

Within 3 seconds, the vehicle gradually and automatically begins moving again.

Beyond 3 seconds, the driver must accelerate or press **4-II** to move off again.

! While the vehicle is immobilised, the following recommendations apply:

- The driver should not leave the vehicle.
- Do not open the boot.
- Do not drop off or pick up passengers.
- Do not engage reverse gear.

! When moving off again, watch out for cyclists, pedestrians and animals, as they may not be detected properly.

Operating limits

Cruise control operates by day and night, in dry weather or moderate rainfall.

Certain situations cannot be managed by the system and require driver intervention.

Cases not taken into account by the system:

- Pedestrians, cyclists, animals.
- Stationary vehicles (e.g. traffic jams, breakdown).

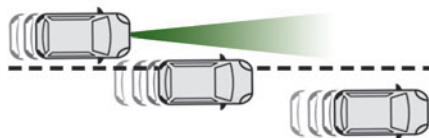

- Vehicles crossing your lane.
- Vehicles driving in the opposite direction.

Situations where the driver must suspend the system:

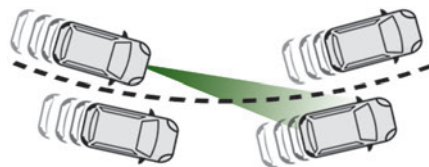

- Vehicles in a tight bend.
- When approaching a roundabout.

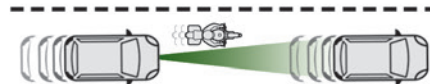

- When following a narrow vehicle. Reactivate the system when conditions allow.

Situations in which the driver is prompted to immediately resume control:

- Excessively sharp deceleration by the vehicle in front of you.

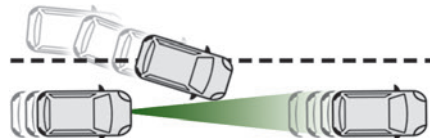

- When a vehicle cuts in sharply between your vehicle and the one in front.

! Some vehicles on the road may be poorly perceived or interpreted by the camera and/or the radar (e.g. truck), which can lead to an incorrect evaluation of distances and result in inappropriate acceleration or braking of the vehicle.

! Pay particular attention:

- When motorcycles are present and when there are vehicles staggered across the traffic lane.

- When entering a tunnel or crossing a bridge.

- !** If any of the following malfunctions occurs, do not use the system:
- Following an impact on the windscreen close to the camera or on the front bumper (versions with radar).
 - Brake lamps not working.

- !** If the vehicle has undergone any of the following modifications, do not use the system:
- Carrying long objects on roof bars.
 - Towing.
 - Front end of the vehicle modified (for example by adding long-range headlamps or painting the front bumper).
 - Obstructed radar and/or camera.

Lane positioning assist

- !** For more information, refer to the **General recommendations on the use of driving and manoeuvring aids.**

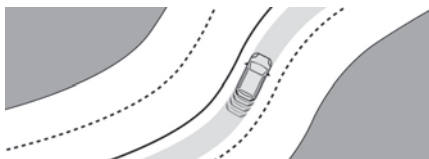

The system identifies the edges of the traffic lane and steers the vehicle to keep it inside this lane and maintain the lateral position chosen by the driver.

To do this, the system uses a camera placed on the upper part of the windscreen. This system is particularly suited to driving on motorways and main roads.

Operating conditions

- Adaptive cruise control active.
- Traffic lane marked out by lines on both sides.
- ESC system operational.
- ASR system activated.
- No trailer detected.
- No 'space-saver' spare wheel in use.
- Vehicle not subject to strong lateral acceleration.
- Direction indicators off upon activation of the system.

Activation/Deactivation



- With Adaptive cruise control with Stop&Go function activated, press this button.

The action is confirmed by:

- The indicator lamp in the button lighting up green.

- The following symbol being displayed on the instrument panel.

The colour of the symbol on the instrument panel depends on the operating status of the system:



(grey colour)

One or more operating conditions is not met; the system is paused.



(green colour)

All operating conditions are met; the system is active.



(orange colour)

System malfunction.

If the driver no longer wishes to use the system for a while, they can deactivate it by pressing the button again.

The indicator lamp in the button goes off and the symbol disappears from the instrument panel.

i The system status is saved when the ignition is switched off.

Cruise control

The driver must hold the steering wheel properly. When cruise control is activated, the symbol is displayed in green: by small steering actions, the system directs the vehicle and keeps it in the position chosen by the driver, in the traffic lane. This position is not necessarily the centre of the lane.

The driver can feel movements in the steering wheel.

The driver can change the position of the vehicle at any time, by turning the steering wheel, which suspends the function. The driver positions the vehicle where they wish to in the lane. When the driver feels that the vehicle's position is appropriate, they maintain it until the function is reactivated. The system regains control by regulating on the new defined position.

Pausing/Suspending the system

! The driver must act promptly if they believe that the traffic conditions or the state of the road surface require their intervention, by moving the steering wheel to temporarily suspend system operation. Any intervention on the brake pedal that causes

the Adaptive cruise control to pause will also cause the system to pause.

! If the system detects that the driver is not holding the wheel firmly enough, it triggers a series of gradual alerts and then deactivates itself if there is no response from the driver.

i If the function is suspended due to the prolonged release of the force holding the steering wheel, the function must be reactivated by pressing the button again.

– Deactivation of the ASR.

Automatic pause











- Triggering of the ESC.
- Prolonged failure to detect one of the lane limit markings. In this case, the Lane keeping assist function can take over, and the system will reactivate itself once the operating conditions are met again.

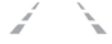

In response to action by the driver: suspension

- Activation of the direction indicators.
- Travelling outside the lane limits.
- Too tight a grip on the steering wheel or dynamic action on the steering wheel.
- Action on the brake pedal (resulting in a pause until cruise control is reactivated) or accelerator pedal (suspension for as long as the pedal is depressed).
- Pausing of Adaptive cruise control.

Driving situations and related alerts

The tables below describe the displays associated with the main driving situations.
The actual order of display of these alerts may be different.

Button indicator lamp	Cruise control thumbwheel	Symbols	Display	Comments
Off	CRUISE	 (grey)	 (grey)	Cruise paused. Lane positioning assist not activated.
Off	CRUISE	 (green)	 (grey)	Active cruise control. Lane positioning assist not activated.
Green	CRUISE	 (green)	 (green)	Drive Assist Plus activated. The system is operating normally (correction is made at the steering wheel).
Green	CRUISE	 (grey)	 (grey)	Drive Assist Plus paused.
Green	CRUISE	 (green)/(grey)	 (grey)	Drive Assist Plus activated. All the operating conditions for lane positioning assist have not been met.
Green	OFF or LIMIT	 (grey)	 (grey)	Cruise control deactivated. All the operating conditions for lane positioning assist have not been met.

Button indicator lamp	Cruise control thumbwheel	Symbols	Display	Comments
Green	CRUISE	 (green)/(grey)	 (grey)	Drive Assist Plus suspended. Cruise control and lane positioning assist are suspended.

Messages	Driving situations
"Activate cruise control to use lane positioning assist"	Activation of lane positioning assist while cruise control is not active.
"Conditions unsuitable - Awaiting activation"	Activation of lane positioning assist while not all conditions are met.
"Keep your hands on the steering wheel"	Prolonged driving without holding the steering wheel, holding it improperly or without applying any force.
"Hold the steering wheel"	Actual or imminent loss of lane positioning assist.
"Take back control"	Simultaneous loss of cruise control and lane positioning assist.

Operating limits

i The system may issue an alert when the vehicle is travelling on a long, straight road with smooth road surface even if the driver thinks they are holding the steering wheel correctly.

The system may not operate or may produce unsuitable corrections to the steering in the following situations:

- Poor visibility (insufficient road lighting, snowfall, rain, fog).

- Dazzle (headlamps of an oncoming vehicle, low sun, reflections on a wet road surface, leaving a tunnel, alternating light and shade).
- Windscreen area in front of the camera dirty, misted up, frost-covered, snow-covered, damaged or covered by a sticker.
- Lane markings eroded, partially hidden (snow, mud) or multiple (roadworks, surface joints).
- Travelling in a tight bend.
- Winding roads.
- Presence of a tarmac joint on the road.

Risk of undesirable operation

- !** The system should be deactivated in the following situations:
- Driving with a "space-saver" type spare wheel.
 - When towing or with a bicycle carrier attached to a towing device, particularly when a trailer is not connected or the trailer is not an approved type.
 - Adverse weather conditions.
 - Driving on slippery road surfaces (risk of aquaplaning, snow, ice).
 - In roadworks or toll booth areas.
 - Driving on racing circuits.

- Driving on a rolling road.

Malfunction



In the event of a malfunction, the Service warning lamp comes on and this (orange) symbol appears on the instrument panel, accompanied by the display of a message and an audible signal.

Have it checked by a PEUGEOT dealer or a qualified workshop.

Lane keeping assist

! For more information, refer to the **General recommendations on the use of driving and manoeuvring aids.**

The system corrects the vehicle's trajectory by alerting the driver as soon as it detects a risk of involuntary lane departure or crossing of a verge or hard shoulder (depending on version).

To do this, the system uses a camera, placed on the upper part of the windscreen, identifying the lane markings on the ground and the side of the road (depending on version).

This system is particularly useful on motorways and main roads.

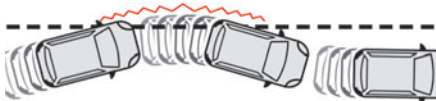

Operating conditions

- Vehicle speed between 43 and 112 mph (70 and 180 km/h).
- Road marked with a central dividing line.
- Steering wheel held with both hands.
- Direction indicators off upon activation of the system.
- ESC system activated and operational.

! The system helps the driver only if there is a risk of the vehicle unintentionally wandering from the lane it is being driven in. It does not manage the safe driving distance, vehicle speed or braking.

The driver must hold the steering wheel with both hands so that they can maintain control when the conditions no longer allow the system to intervene (e.g. in the event that the central dividing line marking on the road surface disappears).

Operation

As soon as the system identifies a risk of involuntarily crossing one of the lane markings detected on the ground or a lane boundary (e.g. grass verge), it performs the trajectory correction necessary to restore the vehicle to its original lane.

The driver will notice a turning movement of the steering wheel.



This warning lamp flashes during trajectory correction.





i The driver can prevent the correction by firmly holding the steering wheel (e.g. during an emergency manoeuvre). The correction is interrupted immediately if the direction indicators are operated.

While the direction indicators are activated and for a few seconds after switching them off, the system considers that a change of trajectory is intentional and no correction is triggered during this period.

Driving situations and related alerts

The table below describes the alerts and messages displayed in different driving situations.

The actual order of display of these alerts may be different.

Function status	Display	Comments
OFF		Function deactivated.
ON	None.	System active, conditions not met: <ul style="list-style-type: none"> – Speed below 40 mph (65 km/h). – No lane marking recognised. – ESC operation triggered. – "Sporty" driving.
ON		Automatic deactivation/standby of the function (e.g. detection of a trailer, use of the "space-saver" type spare wheel supplied with the vehicle, failure).
ON	None.	Lane marking detected. Speed above 40 mph (65 km/h).
ON		The system corrects the trajectory on the side where the risk of line crossing is detected. The driver's hands are on the steering wheel.
ON	  "Hold the steering wheel" or "Stay in lane" (depending on version)	<p>If, while correcting the trajectory, the system determines that the correction will not be enough and that a solid line will be crossed: the driver is warned that they must provide additional trajectory adjustment.</p> <p>If the steering wheel is not held properly, an audible warning sounds, accompanied by a message, until the trajectory correction is completed or the driver has grasped the steering wheel correctly.</p> <p>The duration of audible warnings will increase if multiple corrections are performed in quick succession. The warning will become continuous, persisting until the driver responds.</p>

Operating limits

The system goes into standby automatically in the following cases:

- ESC deactivated or operation triggered.
- Speed below 43 mph (70 km/h) or greater than 112 mph (180 km/h).
- Electrical connection to a trailer.
- Use of a "space-saver" spare wheel detected (as detection is not immediate, deactivation of the system is recommended).
- Dynamic driving style detected, pressure on the brake or accelerator pedal.
- Driving over lane markings.
- Activation of the direction indicators.
- Crossing the inside line on a bend.
- Driving on a tight bend.
- Inactivity by the driver detected during correction.

! The following situations may interfere with the operation of the system or prevent it from working:

- Insufficient contrast between the road surface and the verge or hard shoulder (e.g. shade).
- Lane markings worn, hidden (e.g. snow, mud) or multiple (e.g. roadworks).
- Close proximity to the vehicle in front (lane markings may not be detected).
- Roads that are narrow, winding.

Risk of undesirable operation

The system should be deactivated in the following situations:

- When changing a wheel or working near a wheel.
- Towing or with a bicycle carrier on a towing device, especially with trailer not plugged in or not approved.
- Road in poor condition, unstable or with very poor grip (risk of aquaplaning, snow, ice).
- Adverse weather conditions.
- Driving on racing circuits.
- Driving on a rolling road.

Deactivation/Activation

By default, the system is automatically activated at every engine start.

With Touch screen 10" & Bluetooth Radio & Telephone



It is configured via the **Driving** touch screen menu.

With PEUGEOT i-Connect Advanced - PEUGEOT i-Connect



It is configured in the **ADAS** touch screen application or via the **Shortcuts for driving aids**.



Deactivation is confirmed by the illumination of this indicator lamp on the instrument panel.

Malfunction



In the event of a malfunction, these warning lamps light up on the instrument panel, accompanied by the display of a message and an audible signal. Have it checked by a PEUGEOT dealer or a qualified workshop.



This warning lamp lights up on the instrument panel with the message **"Driving Assistance Sensor blind: Clean sensor, see User Manual"** if the sensor is masked.

This is a normal behavior, which does not request the support of a qualified workshop. In this case, stop the vehicle and verify if the front camera is covered by dirt, mud, sand, snow, ice or anything preventing the sensing. The system is operational again after the detection field has been cleaned.

Blind spot monitoring



For more information, refer to the **General recommendations on the use of driving and manoeuvring aids**.

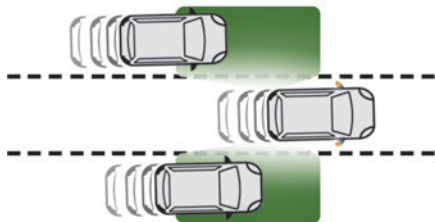

! Depending on the country of sale, the printing of the Blind spot monitoring symbol in the mirror does not necessarily mean that the function is present on the vehicle.

This system warns the driver of a potential danger posed by the presence of another vehicle (car, lorry, motorcycle) in the vehicle's blind spots (areas hidden from the driver's field of vision) using sensors located on the sides of the bumpers.

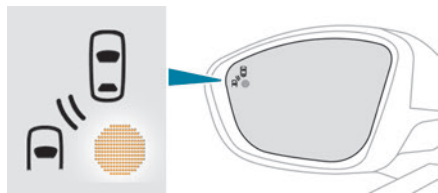

A warning lamp appears in the door mirror on the side in question:

- **fixed**, immediately, when being overtaken.

- **flashing**, after a delay of about one second, when overtaking a vehicle slowly, and when the direction indicator is used.

Activation/Deactivation

With Touch screen 10" & Bluetooth Radio & Telephone



The settings are changed via the **Driving** touch screen menu.

With PEUGEOT i-Connect Advanced - PEUGEOT i-Connect



The settings are changed via the **ADAS** touch screen application.

When starting the vehicle, the warning lamp comes on in each mirror to indicate that the system is activated.

The status of the system is memorised when the ignition is switched off.

- i** The system is automatically deactivated when towing with a towing device approved by PEUGEOT.

Operating conditions

- All vehicles are moving in the same direction and in adjacent lanes.
- The speed of your vehicle must be between 7 and 87 mph (12 and 140 km/h).
- When overtaking a vehicle, the speed difference is less than 6 mph (10 km/h).

- When overtaken by a vehicle, the speed difference is less than 16 mph (25 km/h).
- Traffic is flowing normally.
- Overtaking a vehicle over a certain period of time and the vehicle being overtaken remains in the blind spot.
- You are driving on a straight or slightly curved road.
- Your vehicle is not pulling a trailer, a caravan, etc.

Operating limits

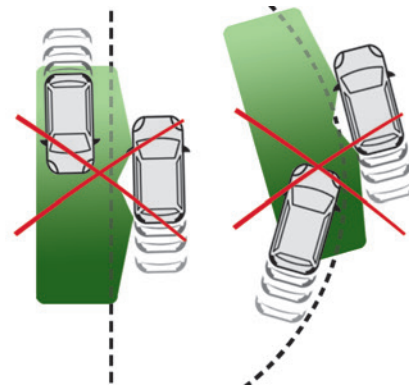

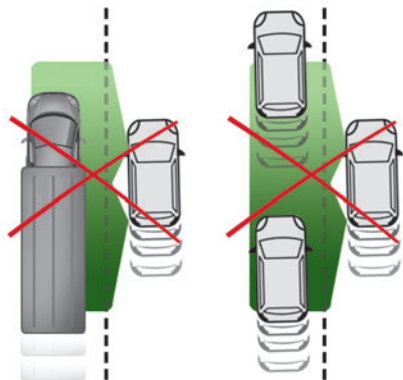

No alert is triggered in the following conditions:

- presence of stationary objects (e.g. parked vehicles, safety rails, lampposts, signs).
- vehicles travelling in the opposite direction.
- on winding roads or in case of sharp turns.
- when overtaking or being overtaken by a very long vehicle (e.g. truck, bus), which is both detected in a blind spot from behind and present in the driver's field of vision from the front.
- quick overtaking manoeuvre.
- very heavy traffic: vehicles detected in front and behind are confused with a lorry or a stationary object.

Malfunction



If the event of a malfunction, this warning lamp lights up on the instrument panel, accompanied by the display of a message.

Have it checked by a PEUGEOT dealer or a qualified workshop.

i The system may be temporarily disturbed by certain weather conditions (e.g. rain, hail).

In particular, driving on a wet road or going from a dry to a wet area can cause false alerts (e.g. presence of a cloud of water droplets in the blind spot interpreted as a vehicle).

In bad or wintry weather, ensure that the sensors are not covered by mud, ice or snow. Take care not to cover the warning zone in the door mirrors, or the detection zones on the front and rear bumpers with adhesive labels or other objects; they may hamper correct operation of the system.

Active Safety Brake with Collision Risk Alert and Intelligent emergency braking assistance

! For more information, refer to the **General recommendations on the use of driving and manoeuvring aids.**



This system:

- warns the driver that their vehicle is at risk of collision with the preceding vehicle, a pedestrian or a cyclist.
- reduces the vehicle's speed to avoid a collision or to limit its severity.

i Below a speed of 19 mph (30 km/h), automatic emergency braking may slow down the vehicle to a complete stop.

Otherwise, for versions with camera only, the speed may be reduced by a maximum of 16 mph (25 km/h).

For versions with camera and radar, the speed reduction may be extended to 31 mph (50 km/h), if both sensors are able to detect the threat.

i The system also takes motorcyclists into account.

It may also react on animals. Animals (especially animals smaller than 0.5 m) and objects on the road are not necessarily detected.

This system includes three functions:

- Collision Risk Alert.
- Intelligent emergency braking assistance (IEBA).

- Active Safety Brake (automatic emergency braking).

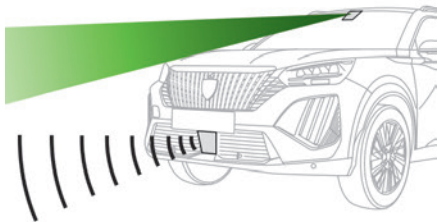

The vehicle has a multifunction camera located at the top of the windscreen and, depending on version, a radar located in the front bumper.

! This system does not replace the need for driver vigilance.

This system is designed to assist the driver and improve road safety.

It is the driver's responsibility to continuously monitor traffic conditions in accordance with applicable driving regulations.

i As soon as the system detects a potential collision, it prepares the braking circuit. This may cause a slight noise and a slight sensation of deceleration.

Operating conditions and limits

Vehicle moving forward without trailer.
Brake system operational.

ASR system activated.
Seat belts fastened for all passengers.
Stabilised speed on roads with no or low curvature.

(E) This warning lamp lights up on the instrument panel without any additional message, to indicate that the automatic braking system is not available.

This is a normal behavior indicating that a condition is not fulfilled and which does not request the support of a workshop.

In all situations with ignition on where automatic braking presents a risk, deactivating the system via the vehicle's configuration menu is recommended, for instance:

- Towing a trailer (particularly a trailer without its own braking system).
- Carrying long objects on roof bars.
- Driving with snow chains.
- Using an automatic car wash.
- Performing any maintenance (e.g. changing a wheel, working inside the engine compartment).
- Placing the vehicle on a rolling bench in a workshop.
- Towing the vehicle.
- Following a damage of the windscreen close to the detection camera.

i The system is automatically deactivated when the use of certain types of "space-saver" spare wheel (smaller diameter)

is detected, or if a fault with the brake pedal switch or at least two brake lamps is detected. Following a severe crash (e.g. with airbag deployment), the system is automatically deactivated.
Have it checked by a PEUGEOT dealer or a qualified workshop.

i In case the detection is degraded or temporarily unavailable by environment conditions, then a driver indication is not displayed (because a driver action is not requested).

! It can be dangerous to drive if the brake lamps are not in perfect working order.

! The driver must not overload the vehicle (keep within the GVW limit and load height limits for roof bars).

Collision Risk Alert

This function warns the driver if there is a risk of collision with the preceding vehicle, or with a pedestrian or cyclist.

Modifying the alert trigger threshold

The trigger threshold determines the sensitivity with which the function warns of the risk of collision.

The selected threshold is memorised when the ignition is switched off.

With Touch screen 10" & Bluetooth Radio & Telephone



The threshold is set via the **Driving** touch screen menu.

► Select one of the three pre-defined thresholds: "**Far**", "**Normal**" or "**Close**".

With PEUGEOT i-Connect Advanced - PEUGEOT i-Connect



The threshold is set via the **ADAS** touch screen application.

► Select one of the 3 preset thresholds: "**Far**", "**Medium**" or "**Near**".

Operation

Depending on the collision risk detected by the system and the alert trigger threshold chosen by the driver, different levels of alert may be triggered and displayed on the instrument panel. The system takes into account the vehicle dynamics, the difference speed of the own vehicle and the object identified for the collision risk, and the operation of the vehicle (e.g. actions on the pedals, steering wheel) to trigger the alert at the most relevant moment.



(orange)

Level 1: visual alert only, warning that the preceding vehicle is very close.

The message "**Vehicle close**" is displayed.



(red)

Level 2: visual and audible alert, warning that a collision is imminent.

The message "**Brake!**" is displayed.

i While approaching a vehicle too quickly, the level 2 alert may be displayed directly.

Important: the level 1 alert depends on the trigger threshold selected. It reacts only on moving vehicles. It is disabled automatically at lower speed.

! It is possible that collision warnings are not given, are given too late or seem unjustified.

The driver must always stay in control of the vehicle and be prepared to react at any time to avoid an accident.

Intelligent emergency braking assistance (iEBA)

This function increases vehicle deceleration if the driver does not brake enough to avoid a collision.

This assistance is only provided if the driver presses the brake pedal.

Active Safety Brake



This function, also called "automatic emergency braking", intervenes after the acoustic alert if the driver does not operate the brake pedal quickly enough.

The system aims at reducing the speed of impact or avoiding a collision if the driver fails to react.

Operation

The system operates subject to the following conditions:

– At reduced speed in an urban environment, when a stationary vehicle, pedestrian or cyclist is detected.

– The vehicle's speed is between 6 mph and 53 mph (10 km/h and 85 km/h) (versions with camera only) or 87 mph (140 km/h) (versions with camera and radar) when a moving vehicle is detected.

 This warning lamp flashes (for approximately 10 seconds) as soon as the function applies the vehicle's brakes.

During the flashing time, the function is not available.

With an automatic gearbox or drive selector, in the event of automatic emergency braking, keep the brake pedal depressed, also after a complete stop is reached, to prevent the vehicle from rolling away.

With a manual gearbox, in the event of automatic emergency braking bringing the vehicle to a complete stop, the engine may stall.

 The driver can override the automatic emergency braking at any time by strongly turning the steering wheel (evasive manoeuvre) and/or by firmly pressing the accelerator pedal.

 The brake pedal may feel hard and vibrate slightly while the function is operating.

If the vehicle comes to a complete stop, automatic braking is maintained for 1 to 2 seconds.

Deactivation/Activation

By default, the system is automatically activated at every engine start.

With Touch screen 10" & Bluetooth Radio & Telephone

 The settings are changed via the **Driving** touch screen menu.

With PEUGEOT i-Connect Advanced - PEUGEOT i-Connect

 The settings are changed via the **ADAS** touch screen application.

 Deactivation of the system is signalled by the illumination of this warning lamp, accompanied by the display of a message.

 The system cannot be deactivated above 10 km/h.

Malfunction



 This warning lamp lights up on the instrument panel with the message "**Driving Assistance Sensor blind: Clean sensor, see User Manual**" if the sensor is masked.



This is a normal behavior, which does not request the support of a qualified workshop. In this case, stop the vehicle and verify if the front camera or the front radar is covered by dirt, mud, sand, snow, ice or anything preventing the sensing.

The system is operational again after the detection field has been cleaned.

 In the event of a malfunction, this warning lamp lights up on the instrument panel, accompanied by the display of a message and an audible signal.

Have it checked by a PEUGEOT dealer or a qualified workshop.

  If these warning lamps come on after the engine has been switched off and then restarted, contact a PEUGEOT dealer or a qualified workshop to have the system checked.

  These warning lamps light up on the instrument panel and/or in the warning lamp display for seat belts and front passenger airbag to indicate that the driver's and/or front passenger's seat belt is not fastened (depending on version). The automatic braking system is deactivated until the seat belts are fastened.

Distraction detection

 For more information, refer to the **General recommendations on the use of driving and manoeuvring aids.**

The function comprises the "Driver Attention Warning" system combined with the "Driver Attention Warning by Camera" system.

! These systems are in no way designed to keep the driver awake or to prevent the driver from falling asleep at the wheel. It is the driver's responsibility to stop if feeling tired. Take a break if you are feeling tired or at least every 2 hours.

Driver Attention Warning



The system triggers an alert when it detects that the driver has not taken a break after two hours of driving at a speed above 43 mph (70 km/h).

This alert is issued via the display of a message encouraging the driver to take a break, accompanied by an audible signal.

If the driver does not follow this advice, the alert is repeated hourly until the vehicle is stopped.

The system resets itself if one of the following conditions is met:

- With the engine running, the vehicle has been stationary for more than 15 minutes.
- The ignition has been switched off for a few minutes.
- The driver's seat belt is unfastened and their door is opened.

i As soon as the speed of the vehicle drops below 43 mph (70 km/h), the system goes into standby. Driving time starts being counted again once the speed reaches above 43 mph (70 km/h).

Driver Attention Warning by Camera

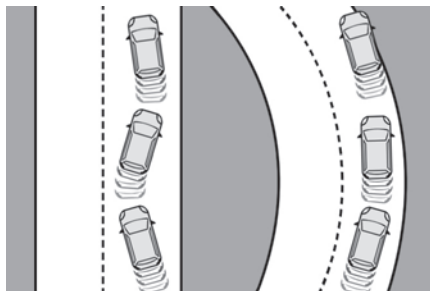

The system assesses the driver's level of alertness, fatigue and distraction by identifying trajectory changes in relation to the lane markings.

To do this, the system uses a camera, placed on the upper part of the windscreen.

This system is particularly suited to fast roads (speed higher than 43 mph (70 km/h)).

i The system may perform a learning procedure for up to 30 minutes after the start of the monitoring. During this period, the driver's individual driving behaviour is analysed and no alert is given.

At a first alert level, the driver is warned by the message "**Caution!**", accompanied by an audible signal.

After three first-level alerts, the system triggers a further alert with the message "**Driving at risk: Take a break**", accompanied by a more pronounced audible signal.

i In certain driving conditions (poor road surface or strong winds), the system may give alerts independent of the driver's level of vigilance.

! The following situations may interfere with the operation of the system or prevent it from working:

- Lane positioning assist is active.
- poor visibility (e.g. inadequate street lighting, heavy rain, thick fog, snowfall).
- dazzle (e.g. headlamps of an oncoming vehicle, low sun, reflections on a damp road, leaving a tunnel, alternating shade and light).
- windscreen area located in front of the camera (e.g. dirty, misted, frost-covered, snow-covered, damaged or masked by a sticker).
- lane markings absent, worn, hidden (e.g. snow, mud, dead leaves) or multiple (roadworks).
- close to the vehicle ahead (lane markings not detected).
- roads that are narrow, winding.

Deactivation / Activation

By default, the function is automatically activated at every engine start.

With Touch screen 10" & Bluetooth Radio & Telephone



The settings are changed via the **Driving** touch screen menu.

With PEUGEOT i-Connect Advanced - PEUGEOT i-Connect



The settings are changed via the **ADAS** touch screen application.

or

Direct access to the **Shortcuts for driving aids**.



Deactivation is confirmed by the illumination of this indicator lamp on the instrument panel.

Malfunction



In the event of a malfunction, this warning lamp lights up on the instrument panel, accompanied by the display of a message and an audible signal.

Have it checked by a PEUGEOT dealer or a qualified workshop.



This warning lamp lights up on the instrument panel with the message **"Driving Assistance Sensor blind: Clean sensor, see User Manual"** if the sensor is masked.

This is a normal behavior, which does not request the support of a qualified workshop.

In this case, stop the vehicle and verify if the front camera is covered by dirt, mud, sand, snow, ice or anything preventing the sensing. The system is operational again after the detection field has been cleaned.

Parking sensors



For more information, refer to the **General recommendations on the use of driving and manoeuvring aids**.

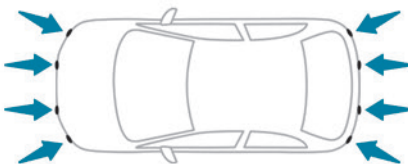

This system detects and signals the proximity of obstacles (e.g. pedestrian, vehicle, tree, barrier) using sensors located in the bumper.

Rear parking sensors

System startup is available under the following conditions:

- when reverse gear is engaged.
- when the vehicle is moving backwards (e.g. downhill, in neutral).

It is indicated by an audible confirmation signal and a display indication.



If an obstacle is detected as soon as the reverse gear is engaged, an audible detection signal is given directly instead of the audible confirmation signal.

If no audible signal is given, the display indication is not shown or a warning message appears, the system has a failure.

Audible assistance

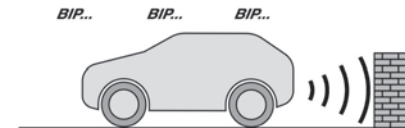

The system signals the presence of obstacles which are both within the sensors' detection zone and in the vehicle path defined by the direction of the steering wheel.

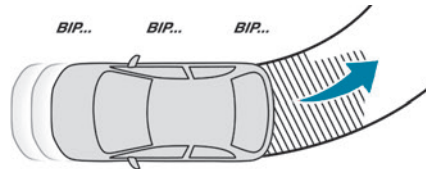

Depending on version, in the example shown, only the obstacles present in the shaded area will be signalled by the audible assistance. The proximity information is given by an intermittent audible signal, the frequency of

which increases as the vehicle approaches the obstacle.

When the distance between the vehicle and the obstacle becomes less than about thirty centimetres, the audible signal becomes continuous.

The sound emitted by the speaker (right or left) indicates the side on which the obstacle is located.

The audible signal is automatically suspended when the vehicle is stationary for a few seconds.

The audible signal is automatically restored when the vehicle is moving again or if the obstacle approaches the vehicle.

i Adjusting the audible detection signal



Pressing this button opens the window for adjusting the volume of the audible signal.



Pressing this button mutes/unmutes the audible signal.

Visual assistance



This supplements the audible signal by displaying bars on the screen whose location

represents the distance between the obstacle and the vehicle (white: more distant, orange: close, red: very close).

When the obstacle is very close, the "Danger" symbol is displayed on the screen.

i Closing the system display window



Pressing this button closes the system display window.



This warning lamp flashes during obstacle detection on the instrument panel.

i Muting the audible assistance / Closing the visual assistance

If the audible detection signal is muted or the system display window is closed by the driver during the obstacle detection, only the warning lamp continues to flash on the instrument panel.

Front parking sensors

Supplementing the rear parking sensors, the front parking sensors are triggered when an obstacle is detected in front and the speed of the vehicle is below 6 mph (10 km/h).

Front parking sensor operation is suspended if the vehicle stops for more than three seconds in forward gear, if an obstacle is no longer detected or the vehicle speed exceeds 6 mph (10 km/h).

i The sound emitted by the speaker (front or rear) locates the obstacle relative to the vehicle, in front or behind it.

Side parking sensors

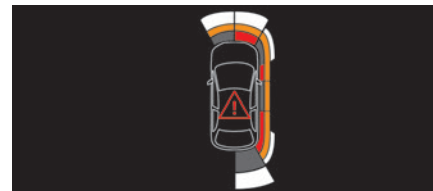

Using four additional sensors located on the sides of the bumpers, the system records the position of obstacles during the manoeuvre and indicates them when they are located alongside the vehicle.

! Only fixed obstacles are indicated correctly. Moving obstacles detected at the beginning of the manoeuvre may be indicated mistakenly, while moving obstacles that appear alongside the vehicle but were not previously recorded will not be indicated.

! Objects memorised during the manoeuvre will no longer be stored after switching off the ignition.

Deactivation/Activation

(Depending on country of sale)

By default, the audible signal is automatically activated at each time the reverse gear is engaged.

i The system cannot be deactivated.

With Touch screen 10" & Bluetooth Radio & Telephone



You can start the system manually and activate/deactivate the audible signal in the **Driving** touch screen menu.

With PEUGEOT i-Connect Advanced - PEUGEOT i-Connect



You can start the system manually and activate/deactivate the audible signal in the **ADAS** touch screen application.



i The rear parking sensors are deactivated automatically if a trailer or bicycle carrier is connected to a towing device installed in accordance with the Manufacturer's recommendations.

In this case, the outline of a trailer is displayed at the rear of the image of the vehicle.

i When starting the vehicle, the graphic and audible aids are only available after the touch screen has started up.

Operating limits

If the boot is heavily loaded, the vehicle may tilt, affecting distance measurements.

In case of a gearbox failure, the system is not active, when the reverse gear is engaged.

Malfunction

i In case of display or speakers malfunction, the system may be disturbed or unavailable.

! In the event of vehicle malfunction, the system may be deactivated.



In the event of a malfunction, this warning lamp lights up on the instrument panel, accompanied by the display of a message and an audible signal (short beep).

Have it checked by a PEUGEOT dealer or a qualified workshop.



This warning lamp lights up on the instrument panel with the message **"Parking Assistance Sensor blind: Clean sensor, see User Manual"** if the sensor is masked.

This is a normal behavior, which does not request the support of a qualified workshop. In this case, stop the vehicle and verify if the front and/or rear sensors are covered by dirt, mud, sand, snow, ice or anything preventing the sensing.

The system is operational again after the detection field has been cleaned.

Visiopark 1 - Visiopark 2

With PEUGEOT i-Connect Advanced - PEUGEOT i-Connect

Visiopark 1

! For more information, refer to the **General recommendations on the use of driving and manoeuvring aids.**

When reverse gear is engaged, with the engine running, this system displays views of the vehicle's close surroundings on the touch screen using a camera located at the rear of the vehicle.

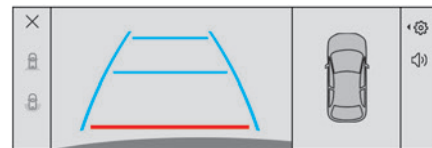

The screen is divided into 3 parts with a side menu, a contextual view and a view from above the vehicle in its close surroundings. The parking sensors supplement the information in the view from above the vehicle.

Different contextual views are available:

- Automatic zoom view.
- Standard view.
- Panoramic view.

Depending on the context, the system chooses the best view to display (standard or automatic zoom).

The view type can be changed at any time during the manoeuvre.

The system status is not saved when the ignition is switched off.

Operating principle

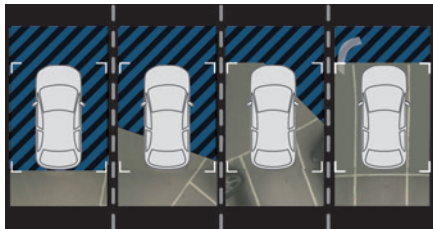

Using the camera, the vehicle's close surroundings are recorded during low speed manoeuvres.

An image from above the vehicle in its close surroundings is created in real time (on the side of the screen), as the vehicle progresses.

This view makes it easier to align the vehicle when parking and to perceive nearby obstacles. It is automatically deleted if the vehicle remains stationary for too long.

An additional jet is fitted above the number plate to clean the reversing camera (depending on version).

► The washing of the reversing camera is triggered by operating the rear screenwash.

Settings

In the side menu:



This window allows to carry out the following operations:

- adjust the volume of the audible signal.
- trig the camera washing (depending on equipment).



This button allows to mute/unmute the audible signal.

Activation/Deactivation

To activate the camera, engage reverse gear.

The system is deactivated:

- when changing out of reverse gear.
- by pressing the cross in the top left-hand corner of the touch screen.

Automatic zoom view

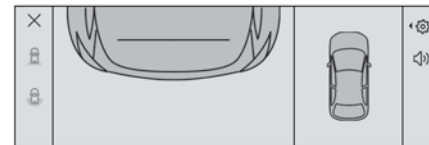

The rear camera records the vehicle's surroundings during the manoeuvre in order to create a view from above the rear of the vehicle in its close surroundings, allowing the vehicle to be manoeuvred around nearby obstacles.

Using the sensors located on the rear bumper, the automatic zoom view is displayed when approaching an obstacle at the red line (less than 30 cm) during the manoeuvre.

This view is only available automatically.

i Obstacles may appear further away than they actually are.

It is important to monitor the sides of the vehicle during the manoeuvre, using the mirrors.

Parking sensors also provide additional information about the area around the vehicle.

Standard view

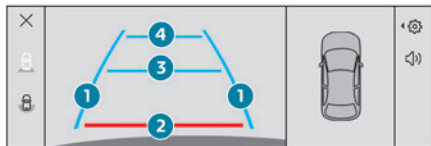

The area behind the vehicle is displayed on the screen.
The blue lines **1** represent the width of your vehicle, with the mirrors unfolded; their direction changes according to the position of the steering wheel.

The red line **2** represents a distance of 30 cm from the rear bumper; the two blue lines **3** and **4** represent 1 m and 2 m, respectively.

This view is available automatically or by selection in the side menu.

Panoramic view



The panoramic view allows you to leave, in reverse, a parking space by anticipating the arrival of vehicles, pedestrians or cyclists.
This view is not recommended for carrying out a complete manoeuvre.

This view is only available by selection in the side menu.

Visiopark 2

! For more information, refer to the **General recommendations on the use of driving and manoeuvring aids.**

This system allows you to view your vehicle's close surroundings on the touch screen using cameras, located at the front and rear of the vehicle.

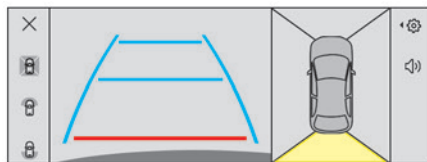

The screen is divided into 4 parts with two side menus, a contextual view and a view from above the vehicle in its close surroundings.

The parking sensors supplement the information in the view from above the vehicle.

Depending on the view angle chosen in the left-hand side menu, the system provides specific visual assistance in particular driving conditions, such as entering a blind intersection or manoeuvring in areas with reduced visibility.

Different contextual views are available for the rear or for the front:

- Automatic zoom view.
- Standard view.
- Panoramic view.

Depending on the context, the system chooses the best view to display (standard or automatic zoom).

The view type can be changed at any time during the manoeuvre.

The system status is not saved when the ignition is switched off.

Operating principle

Reconstructed view

The cameras are activated and a reconstruction of a view from above your vehicle in its close surroundings is displayed on the touch screen.

Live view

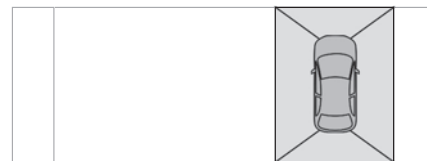

The front and rear views automatically appear in the view from above the vehicle.

It is also possible to display any live view by selecting the corresponding zone.

The front view can be selected in forward gear up to 10 mph (16 km/h).

i Installing the very cold climate screen can alter the image transmitted by the front camera.

Settings

In the side menu:

 This window allows to carry out the following operations:

- adjust the volume of the audible signal.
- adjust the brightness.
- adjust the contrast.
- trig the camera washing (depending on equipment).

 This button allows to mute/unmute the audible signal.

Activation/Deactivation

Automatic

With the rear camera, engine running and vehicle stationary, rear vision is displayed automatically if reverse gear is engaged. With the front camera, engine running and speed below 10 mph (16 km/h), rear vision is displayed automatically if a gear is engaged.

Manual

 ▶ In the **ADAS** touch screen application, select **Functions>Panoramic Camera**

The system is deactivated:

- automatically for the rear, when changing out of reverse gear.

- automatically for the front, above approximately 10 mph (16 km/h).
- by pressing the cross in the top left-hand corner of the touch screen.

Automatic zoom view

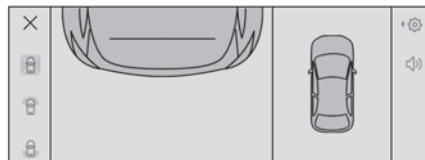

The front or rear camera records the surroundings during the manoeuvre to create a front or rear view from above the vehicle in its close surroundings, making it possible to manoeuvre the vehicle around the surrounding obstacles.

Using the sensors located on the front or rear bumper, the automatic zoom view is displayed when approaching an obstacle at the red line (less than 30 cm) during the manoeuvre.

This view is only available automatically.

Depending on version, it can be activated/deactivated in the **ADAS** application of the touch screen.

i Obstacles may appear further away than they actually are.

It is important to monitor the sides of the vehicle during the manoeuvre, using the mirrors.

Parking sensors also provide additional information about the area around the vehicle.

Standard view

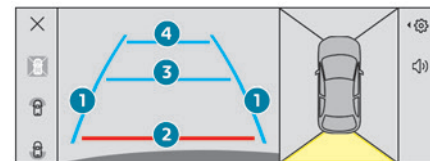

Depending on the context, the area behind or in front of your vehicle is displayed on the screen. The blue lines (at the rear)/orange lines (at the front) **1** represent the width of your vehicle, with the mirrors unfolded; their direction changes according to the position of the steering wheel. The red line **2** represents a distance of 30 cm from the rear or front bumper; the two blue lines (at the rear)/orange lines (at the front) **3** and **4** represent 1 m and 2 m respectively. This view is available automatically or by selection in the left-hand side menu.

Panoramic view



The rear or front panoramic view allows you to leave a parking space by anticipating the arrival of vehicles, pedestrians or cyclists.

This view is not recommended for carrying out a complete manoeuvre.

This view is only available by selection in the left-hand side menu.



Peugeot & TotalEnergies, a partnership in performance !

For more than 25 years of partnership, TotalEnergies and Peugeot have pushed the limits of performance in sports competition with historic victories, in endurance races or in rallies. Today, the two brands continue their common motorsport adventure by setting out to conquer the 24h of Le Mans and the FIA World Endurance Championship in the Hybrid Hypercar category. So many challenges for which Peugeot exclusively recommends high-tech Quartz lubricants for the protection of its engines throughout their life. TotalEnergies therefore equips Peugeot vehicles with Quartz lubricants from their first filling in the factory to the approved maintenance networks to guarantee them optimal day-to-day operation. Peugeot & TotalEnergies: official partners in performance !

Keep your engine younger for longer !

Quartz Ineo Xtra First 0W-20 is a very high performance lubricant resulting from the joint work of the Peugeot and TotalEnergies R&D teams. Its innovative technology extends your engine's life while reaching significant fuel savings and thus limiting CO₂ emissions. The product is now available in new packaging* made of 50% recycled material and 100% recyclable.



* 1L & 5L produced in Europe



PEUGEOT RECOMMENDS **TotalEnergies**

OFFICIAL PARTNERS

Compatibility of fuels



Petrol fuels conforming to the EN228 standard containing up to 5% and 10% ethanol respectively.



Diesel fuels conforming to the EN590, EN16734 and EN16709 standards and containing up to 7%, 10%, 20% and 30% fatty acid methyl ester respectively. The use of B20 or B30 fuels, even occasionally, imposes special maintenance conditions referred to as "Arduous conditions".



Paraffinic Diesel fuel conforming to the EN15940 standard.

! The use of any other type of (bio) fuel (e.g. pure or diluted vegetable or animal oils, domestic fuel) is strictly prohibited - risk of damaging the engine and fuel system!

i The only fuel additives authorised for use are those that meet the B715001 (Petrol) or B715000 (Diesel) standards.

Diesel at low temperature

At temperatures below 0 °C (+32 °F), the formation of paraffins in summer-type Diesel

fuels could prevent the engine from operating correctly. In these temperature conditions, use winter-type Diesel fuel and keep the fuel tank more than 50 % full.

At temperatures below -15 °C (+5 °F) to avoid problems starting, it is best to park the vehicle under shelter (heated garage).

Travelling abroad

Certain fuels could damage your vehicle's engine.

In certain countries, the use of a particular fuel may be required (specific octane rating, specific trade name, etc.) to ensure correct operation of the engine.

For all additional information, consult a dealer.

Refuelling

Fuel tank capacity: approximately 44 litres (Petrol) or 41 litres (Diesel).

Reserve level: approximately 5 litres.

Low fuel level



When the low fuel level is reached, this warning lamp lights up on the instrument panel, accompanied by the display of a message and an audible signal. When it first comes on, **about 5 litres** of fuel remain.

Until sufficient fuel is added, this warning lamp appears every time the ignition is switched on, accompanied by the message and the audible signal. When driving, this message and audible

signal are repeated with increasing frequency as the fuel level drops towards **0**.

You must refuel as soon as possible to avoid running out of fuel.

For more information on **Running out of fuel (Diesel)**, refer to the corresponding section.

i A small arrow by the warning lamp indicates which side of the vehicle the fuel filler flap is located on.

! **Stop & Start**
Never refuel with the engine in STOP mode; you must switch off the ignition.

Refuelling

When refuelling, at least 5 litres must be added in order to be registered by the fuel gauge. Opening the filler cap may create a noise caused by an inrush of air. This vacuum is normal, caused by the sealing of the fuel system. To refuel in complete safety:

► **Always switch off the engine.**

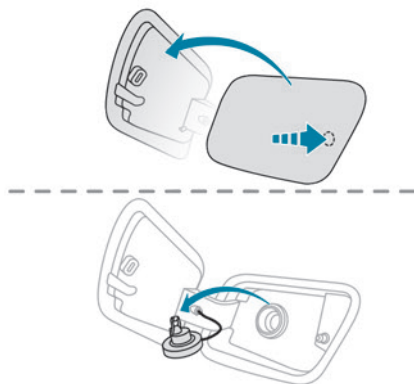

- ▶ With the vehicle unlocked, press the rear-central part of the filler flap to open it.
- ▶ Take care to select the pump that delivers the correct fuel type for your vehicle's engine (see a reminder label on the inside of the filler flap).
- ▶ Turn the filler cap to the left, remove it and place it on its support (on the filler flap).
- ▶ Insert the filler nozzle and push it in as far as possible before starting to refuel (to minimise the risk of splashing).

Do not continue after the nozzle's third cut-out. Doing so may cause malfunctions.

- ▶ Put the filler cap back in place and turn it to the right.
- ▶ Close the fuel filler flap.

! If you have put in the wrong fuel for the vehicle, you must have the fuel tank

drained and filled with the correct fuel before starting the engine.

The vehicle is fitted with a catalytic converter, which helps to reduce the level of harmful emissions in the exhaust gases.

For petrol engines, you must use unleaded fuel.

The filler neck is narrower, admitting unleaded petrol nozzles only.

Misfuel prevention (Diesel)

(Depending on country of sale.)

This mechanical device prevents filling the tank of a Diesel vehicle with petrol.

Located in the filler neck, the misfuel prevention device is visible when the filler cap is removed.

Operation

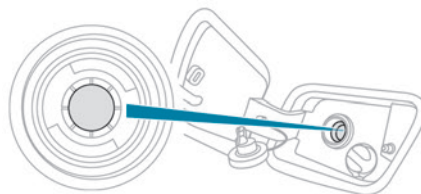

When a petrol filler nozzle is introduced into the fuel filler neck of a Diesel vehicle, it comes into contact with the flap. The system remains closed and prevents filling.

Do not persist but introduce a Diesel type filler nozzle.

i The misfuel prevention device does not prevent filling with a jerrycan, regardless of the fuel type.

i Travelling abroad

As Diesel fuel pump nozzles may be different in other countries, the presence of the misfuel prevention device may make refuelling impossible.

Before travelling abroad, it is advisable to check with a PEUGEOT dealer if the vehicle is suitable for the distribution equipment of the countries visited.

Electrified vehicles - General recommendations

These recommendations and general information concern electrified vehicles of the type: hybrid, rechargeable hybrid and electric.

High voltage system

! High voltage system voltage is dangerous and can cause burns or other injuries or even fatal electric shock.

Since damage to high voltage components is not visible, PEUGEOT recommends that you:

- Never touch the components, damaged or not, and never let your jewelry or other

metallic objects come into contact with these components.

- Never work on the high voltage cables (purple or orange) or on any other high voltage component marked with the Electric risk label. Any intervention on the high voltage system must be carried out by qualified persons in workshops qualified and approved to carry out this type of work.

- Never damage, modify or remove the high voltage cables (purple or orange) or disconnect them from the high voltage network.

- Never open, modify or remove the cover of the traction battery.

- Never work with cutting and forming tools or heat sources near high voltage components and cables.

In case of low level of fluid in the cooling tank, the refilling shall only be performed in a qualified and trained workshop to verify that the leakage is not in the traction battery. Any intervention on the high voltage system must be carried out by qualified persons in workshops qualified and approved to carry out this type of work.

Damage to the vehicle or the traction battery could result in the leakage of toxic gases or fluids either immediately or later. PEUGEOT recommends that you:

- Always inform the fire and emergency services in the event of an incident, warning

that the vehicle is equipped with a traction battery.

- Never touch the liquids leaking from the traction battery.

- Do not inhale the gases emitted by the traction battery which are toxic.

- Move away from the vehicle in the event of incident or accident, the gases emitted being flammable and could cause a fire.

Traction battery

Traction battery overheating



If the following warning lamps appear, accompanied by the display of a message and an audible signal, it is required to:

- ▶ Stop the vehicle as soon as possible in the best conditions of safety.
- ▶ Switch off the ignition.
- ▶ Evacuate the vehicle as quickly as possible and move to a safe distance.
- ▶ Call the fire department and/or the emergency services and tell them that the vehicle is an electric one.



Danger of death / Risk of serious injury

A chain reaction can occur up to a traction battery fire.

! In the event of damage to the traction battery

It is strictly prohibited to work on the vehicle yourself.

Do not touch liquids coming from the battery, and in the event of skin contact with these products, wash abundantly with water and contact a doctor as soon as possible.

Contact a PEUGEOT dealer or a qualified workshop to have the system checked.

Disposal of the traction battery

The traction battery is designed for the life of the vehicle if the recommendations of PEUGEOT are followed.

If it becomes necessary to replace the battery, contact the PEUGEOT dealer for instructions on its disposal. Improper disposal carries the risk of severe burns, electric shock, and damage to the environment.

In accordance with regulations, PEUGEOT ensures a second life or recycling of this component in collaboration with qualified operators.

Charging system (Electric)

400 V electrical system

The electric drive system, which operates at a voltage of approximately 400 V, is identified by

orange cables and its components are marked with this symbol:



! An electric vehicle's power train can become hot during use and after switching off the ignition. Comply with the warning messages shown on the labels, particularly inside the charging flap.

! High voltage system voltage is dangerous and can cause burns or other injuries or even fatal electric shock. Since damage to high voltage components is not visible, PEUGEOT recommends that you:

- Never touch the components, damaged or not, and never let your jewelry or other metallic objects come into contact with these components.
- Never work on the orange high voltage cables or on any other high voltage component marked with the Electric risk label. Any intervention on the high voltage system must be carried out by qualified persons in workshops qualified and approved to carry out this type of work.

- Never damage, modify or remove the orange high voltage cables or disconnect them from the high voltage network.
- Never open, modify or remove the cover of the traction battery.
- Never work with cutting and forming tools or heat sources near high voltage components and cables.

In case of low level of fluid in the cooling tank, the refilling shall only be performed in a qualified and trained workshop to verify that the leakage is not in the traction battery. Any intervention on the high voltage system must be carried out by qualified persons in workshops qualified and approved to carry out this type of work.

Damage to the vehicle or the traction battery could result in the leakage of toxic gases or fluids either immediately or later. PEUGEOT recommends that you:

- Always inform the fire and emergency services in the event of an incident, warning that the vehicle is equipped with a traction battery.
- Never touch the liquids leaking from the traction battery.
- Do not inhale the gases emitted by the traction battery which are toxic.
- Move away from the vehicle in the event of incident or accident, the gases emitted being flammable and could cause a fire.

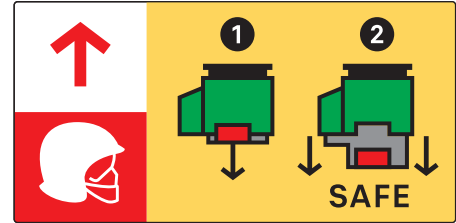

! This label is intended solely for use by firefighters and maintenance services in the event of any work on the vehicle. No other person must touch the device shown on this label.

! **In the event of an accident or impact to the vehicle's underbody**

In these situations, the electrical circuit or the traction battery can be seriously damaged. Stop as soon as it is safe to do so and switch off the ignition. Contact a PEUGEOT dealer or a qualified workshop.

! **When washing**

Before washing the vehicle, always check that the charging flap is closed correctly. Never wash the vehicle while the battery is on charge.

! High-pressure washing

To avoid damaging the electrical components, it is expressly prohibited to use high-pressure washing in the engine compartment or under the body. Do not use a pressure greater than 80 bar when washing the bodywork.

! Never allow water or dust to enter the connector or charging nozzle - risk of electrocution or fire!

Never connect / disconnect the charging nozzle or cable with wet hands - risk of electrocution!

Traction battery

This battery stores the energy that powers the electric motor and the thermal comfort equipment in the passenger compartment. It is discharged during use, and must therefore be regularly recharged. There is no need to wait for the traction battery to fall to its reserve level before recharging.

The range of the battery may vary according to the type of driving, the route, the use of thermal comfort equipment and the ageing of its components.

i The lifespan of the traction battery depends on multiple factors, such as climatic conditions, distance travelled and how often it has been fast-charged.

! To preserve the mileage of your vehicle and the durability of your traction battery, PEUGEOT recommends that you:

- Do not fully charge the battery of your electric vehicle daily (charge the traction battery below 80% as often as possible).
- Do not completely discharge the battery.
- Do not store the vehicle for a long period of non-use (more than 12 hours) when the traction battery has a low or high charge level. Prefer a charge level between 20 and 40%.
- Limit the use of fast charging.
- Do not expose the vehicle to temperatures below -30°C and above +60°C for more than 24 hours.
- Avoid charging the vehicle at negative temperatures (except if the vehicle ran more than 20 minutes) or above +30°C.
- Do not use the vehicle's traction battery as a generator of energy.
- Do not use a generator to recharge your vehicle's traction battery.

! In the event of damage to the traction battery

It is strictly prohibited to work on the vehicle yourself. Do not touch liquids coming from the battery, and in the event of skin contact with these products, wash abundantly with water and contact a doctor as soon as possible. Contact a PEUGEOT dealer or a qualified workshop to have the system checked.

Traction battery overheating



If the following warning lamps appear, accompanied by the display of a message and an audible signal, it is required to:

- ▶ Stop the vehicle as soon as possible in the best conditions of safety.
- ▶ Switch off the ignition.
- ▶ Evacuate the vehicle as quickly as possible and move to a safe distance.
- ▶ Call the fire department and/or the emergency services and tell them that the vehicle is an electric one.

! Danger of death / Risk of serious injury

A chain reaction can occur up to a traction battery fire.

Disposal of the traction battery

The traction battery is designed for the life of the vehicle if the recommendations of PEUGEOT are followed.

If it becomes necessary to replace the battery, contact the PEUGEOT dealer for instructions on its disposal. Improper disposal carries the risk of severe burns, electric shock, and damage to the environment.

In accordance with regulations, PEUGEOT ensures a second life or recycling of this component in collaboration with qualified operators.

Charging connectors and indicator lamps

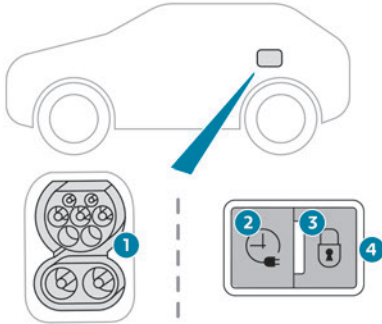

1. Charging connectors
2. Deferred charging activation button
Fixed red: nozzle positioned correctly and locked in the connector.
Flashing red: nozzle incorrectly positioned or locking not possible.
3. Nozzle locking indicator lamp
4. Charging indicator lamp



State of charging indicator lamp	Meaning
Fixed white	Welcome lighting on opening the flap and disconnecting the charging cable.
Flashing white	Charging initialisation.
Fixed blue	Deferred charging.
Flashing green	Charging.
Fixed green	Charging complete. The charging indicator lamp goes off after about 2 minutes as the vehicle's functions go into standby. The indicator lamp comes on again when the vehicle is unlocked with the Keyless Entry and Start system or when a door is opened to indicate that the battery is fully charged.
Fixed red	Malfunction.

! In case of impact, even light, against the charging flap, do not use it.

Do not dismantle or modify the charging connector - risk of electrocution and/or fire!
Contact a PEUGEOT dealer or a qualified workshop.

Charging cables, sockets and chargers

The charging cable supplied with the vehicle (depending on version) is compatible with the electrical systems in the country of sale. When travelling abroad, check the compatibility of local electrical systems with the charging cable.

A full range of charging cables is available from your dealer.



Contact a PEUGEOT dealer or a qualified workshop for more information and to obtain suitable charging cables.

Identification labels on charging sockets/connectors

Identification labels are affixed to the vehicle, charging cable and charger to inform the user about which device needs to be used.

















The meaning of each identification label is as follows:

















Identification label	Location	Configuration	Power type/Voltage range
	Charging connector (vehicle side)	TYPE 2	AC < 480 Vrms
	Charging socket (charger side)	TYPE 2	AC < 480 Vrms
	Charging connector (vehicle side)	COMBO 2 (FF)	DC 50 V – 500 V

4. The weight of the control unit must not be borne by the electrical socket, plug and cables.
5. Never use this charging cable if it is defective or in any way damaged.
6. Never attempt to repair or open this charging cable. It contains no repairable parts - replace the charging cable if it is damaged.
7. Never immerse this charging cable in water.
8. Never use this charging cable with an extension cable, a multi-plug socket, a conversion adaptor or on a damaged electrical socket.
9. Do not unplug the plug from the wall as a means of stopping charging.
10. Immediately stop charging, by locking and then unlocking the vehicle using the remote control key, if the charging cable or wall socket feel burning hot to the touch.
11. This charging cable includes components liable to cause electrical arcing or sparks. Do not expose to flammable vapours.
12. Only use this charging cable with PEUGEOT vehicles.
13. Never plug the cable into the wall socket (or unplug it) with wet hands.
14. Do not force the connector if it is locked into the vehicle.

Control unit label - State of indicator lamps

	State of the indicator lamp
Off	
On	
Flashing	

POWER	CHARGE	FAULT	Symbol	Description
				Not connected to the power supply or power is not available from the infrastructure.
 (green)	 (green)	 (red)		The control unit is currently performing a self-test.
 (green)				Connected only to the infrastructure or to the infrastructure and to the Electric Vehicle (EV) but no charging in progress.

POWER	CHARGE	FAULT	Symbol	Description
 (green)	 (green)			Connected to the power supply and to the Electric Vehicle (EV). The EV is on charge or in a temperature pre-conditioning sequence.
 (green)	 (green)			Connected to the power supply and to the Electric Vehicle (EV). The EV is waiting for charging or the charging of the EV is completed.
		 (red)		Control unit malfunction. No charging allowed. If an error indicator reappears after a manual reset, the control unit must be checked by a PEUGEOT dealer before the next charge.
 (green)	 (green)	 (red)		The control unit is in diagnostic mode.

Manual reset procedure

The control unit can be reset by simultaneously disconnecting the charging connector and the wall socket. Then, reconnect the wall socket first. For more information, refer to the handbook.

Accelerated charging, mode 3

Accelerated charging unit (depending on version)

(accelerated charging - single-phase or three-phase alternating current (AC))

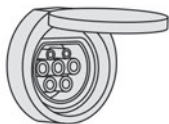

In mode 3 with an accelerated charging unit: 32 A maximum charging current.



In mode 3 with an accelerated charging unit (Wallbox): 32 A maximum charging current.

Charging cable, mode 3 (AC)

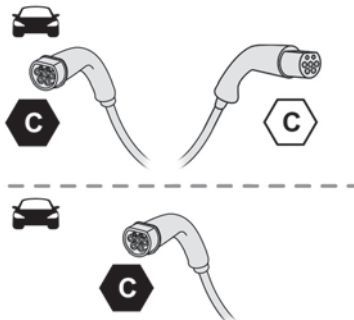

Identification labels **C** on the charging connector (vehicle side) and on the socket (charger side).

! Accelerated charging unit

Do not disassemble or modify the charging unit - Risk of electrocution and/or fire!

Refer to the charging unit manufacturer's user manual for the operating instructions.

Superfast charging, mode 4

Fast public charger
(superfast charging - direct current (DC))

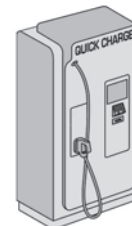

Charging cable, mode 4 (DC)
(integrated into the fast public charger)

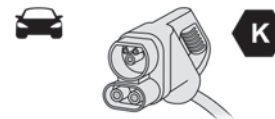

Identification label **K** on the charging connector (vehicle side).

Only use fast public chargers where the cable length does not exceed 30 metres.

Charging the traction battery (Electric)

To recharge, connect the vehicle to a domestic electricity supply (domestic or accelerated charging) or to a fast public charger (superfast charging).

For a full charge, follow the desired charging procedure without pausing it, until it ends automatically. Charging can be either immediate or deferred (except fast public charger, mode 4). You can stop domestic or accelerated charging at any time by unlocking the vehicle and removing the nozzle. For superfast charging, refer to the fast public charger. For more information on the charging displays on the **Instrument panel** and the **Touch screen**, refer to the corresponding section.

i It is also possible to monitor the charging progress using the **MYPEUGEOT APP** application. For more information on **Remotely operable additional functions**, refer to the corresponding section.

! As a safety measure, the engine will not start if the charging cable is plugged into the connector on the vehicle. A warning is displayed on the instrument panel.

i **Cooling the traction battery**
The cooling fan in the engine compartment comes on during charging to cool the on-board charger and the traction battery.

! **Low charging / Driving**
Driving when the charge level of the traction battery is too low can lead to the

vehicle breaking down and can lead to accidents or serious injuries. **ALWAYS** make sure the traction battery has a sufficient charge level.

! **Low charging / Parking**
If the outside temperature is negative, it is recommended not to park your vehicle outside for several hours at a low charging (less than 20%).

! **Vehicle in storage for more than 1 month**
In the event of a long period of non-use of the vehicle (beyond 4 weeks) without the possibility of charging when restarting, the self-discharge may make it impossible to restart if the traction battery charge level is a low or very low, especially at negative ambient temperatures. **ALWAYS** make sure that the traction battery has a charge between 20% and 40% if you do not plan to use your vehicle for several weeks.

Do not connect the charging cable. Always park the vehicle in a place with temperatures between -10°C and 30°C (parking in a place with extreme temperatures can damage the traction battery). Disconnect the cable from the (+) terminal of the accessory battery in the engine compartment.

Connect a 12 V battery charger to the (+) and (-) terminals of the accessory battery about every 3 months in order to recharge the accessory battery and maintain an operating voltage.

Precautions

Our electric vehicles have been developed in accordance with the recommendations on the maximum limits for electromagnetic fields, as issued by the International Commission on Non-ionizing Radiation Protection (ICNIRP - 1998 Guidelines).

Wearers of pacemakers or equivalent devices



Ask your doctor about what precautions you should take, or ask the manufacturer of your implanted electro-medical device about whether its operation is guaranteed in an environment which complies with the ICNIRP recommendations.

! **If in doubt**
Domestic or accelerated charging: do not remain inside or near the vehicle, or near the charging cable or charging unit, even for a short time.
Superfast charging: do not use the system yourself and avoid approaching public fast charging points. Leave the area and ask a third party to recharge the vehicle.

For domestic or accelerated charging

! Before charging

Depending on the context:

- ▶ Have a professional check that the electrical system to be used complies with applicable standards and is compatible with the vehicle.
 - ▶ Have a professional electrician install a dedicated domestic power socket or accelerated charging unit (Wallbox) compatible with the vehicle.
- You should preferably use the charging cable available as an accessory.
- For more information, contact a PEUGEOT dealer or a qualified workshop.

! During charging

While charging is in progress, unlocking the vehicle will cause the charging to stop. If no action is taken on one of the openings (door or boot) or on the charging nozzle, the vehicle will lock again after 30 seconds and charging will resume automatically.

Never work under the bonnet:

- Some areas remain very hot, even an hour after charging ends - risk of burns!
- The fan may start at any time - risk of cuts or strangulation!

! After charging

Check that the charging flap is closed.

Do not leave the cable connected to the domestic power socket - risk of short-circuit or electrocution in the event of contact with or immersion in water!

For superfast charging

i Before charging

Check that the fast public charging station and its charging cable are compatible with the vehicle.

If the exterior temperature is below:

- 0°C, charging times may be extended.
- -20°C, charging is still possible, but charging times may be extended even further (the battery has to be heated first).

! After charging

Check that the charging flap is closed.

Connection

- ▶ Before charging, check that the drive selector is in mode **P**, otherwise charging is not possible.
- ▶ Open the charging flap by pressing the push-button, and check that there are no foreign bodies on the charging connector.

Domestic charging, mode 2

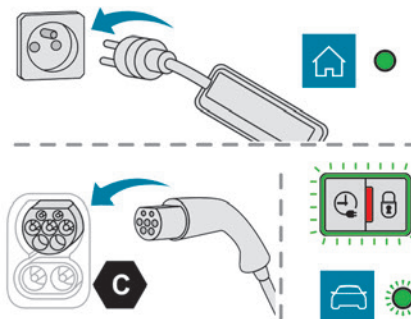

- ▶ Connect the charging cable from the control unit to the domestic socket.

When the connection is made, all of the indicator lamps on the control unit light up, then only the **POWER** indicator lamp remains on in green.

- ▶ Remove the protective cover from the charging nozzle.
- ▶ Insert the nozzle into the charging connector. The start of charging is confirmed by the flashing green **CHARGE** indicator lamps in the flap, then those on the control unit.

If this is not the case, charging has not started; restart the procedure, ensuring that all connections are properly established. The red indicator lamp in the flap comes on to indicate that the nozzle is locked.

- i When charging is complete and while the charging cable is still connected, opening

the driver's door will display the charge level on the instrument panel for about 20 seconds.

Accelerated charging, mode 3



- ▶ Follow the accelerated charging unit (Wallbox) user instructions.
- ▶ Remove the protective cover from the charging nozzle.
- ▶ Insert the nozzle into the charging connector. The start of charging is confirmed when the charging indicator lamp in the flap flashes green. If this is not the case, charging has not started; restart the procedure, ensuring that the connection has been properly established. The red indicator lamp in the flap comes on to indicate that the nozzle is locked.

Superfast charging, mode 4



- ▶ Depending on version, remove the protective cover from the lower part of the connector.

- ▶ Follow the instructions for use of the fast public charger and connect the cable from the fast public charger to the vehicle's connector. The start of charging is confirmed by the flashing green charging indicator lamp in the flap. If this is not the case, charging has not started; restart the procedure, ensuring that the connection is properly established. The red indicator lamp in the flap comes on to indicate that the nozzle is locked.

Deferred charging

The deferred charging start time is set to midnight by default. Depending on equipment, this time can be changed.

Settings

On a smartphone or tablet

- ▶ You can programme the deferred charging function at any time via the **MYPEUGEOT APP** application. For more information on **Remotely operable additional functions**, refer to the corresponding section.

In the vehicle, with Touch screen 10" & Bluetooth Radio & Telephone

- ▶ In the **Energy** touch screen menu, select the **Charge** page.
- ▶ Set the charging start time.
- ▶ Press **OK**.

The setting is saved in the system.

In the vehicle, with PEUGEOT i-Connect Advanced - PEUGEOT i-Connect



- ▶ In the **Energy** touch screen application, select the **Charging** tab.
- ▶ Set the charging start time.
- ▶ Press **OK**.

Activation

- ▶ Deferred charging is only possible with modes 2 and 3.

- ▶ After programming the deferred charging, connect your vehicle to the desired charging equipment.



- ▶ Lock the vehicle.
- ▶ Press this button in the flap within one minute to activate the system (confirmed by the charging indicator lamp coming on in blue).

Disconnection



Before disconnecting the nozzle from the charging connector:

► If the vehicle is unlocked, **lock it and then unlock it**.

► If the vehicle is locked, unlock it. The red indicator lamp in the flap goes out to confirm that the charging nozzle is unlocked.

► In modes 2 and 3, remove the charging nozzle within **30 seconds**.

The charging indicator lamp comes on in white.

i With selective door unlocking activated, press the unlocking button twice to disconnect the charging nozzle.

i When charging is complete, the green charging indicator lamp in the flap goes out after about 2 minutes.

Domestic charging, mode 2

The end of charging is confirmed when the green **CHARGE** indicator lamp on the control unit and the green charging indicator lamp in the flap come on fixed.

► Replace the protective cover on the charging nozzle and close the charging flap.

► Disconnect the control unit end of the charging cable from the domestic socket.

Accelerated charging, mode 3

The end of charging is indicated by the charging control unit and by the fixed lighting of the green indicator lamp in the flap.

► Hang up the nozzle on the charging unit and close the charging flap.

Superfast charging, mode 4

The end of charging is indicated by the charger and by the fixed lighting of the green indicator lamp in the flap.



► You can also pause charging by pressing this button in the flap (in mode 4 only).

► Hang up the nozzle on the charger.

► Depending on version, replace the protective cover on the lower section and close the charging flap.

i When the charging nozzle is disconnected, a message on the instrument panel indicates that charging is complete, even if the charging nozzle was disconnected before full charging was completed.

Towing device

Load distribution

► Distribute the load in the trailer so that the heaviest items are as close as possible to the axle, and the nose weight approaches the maximum permitted without exceeding it.

Air density decreases with altitude, thus reducing engine performance. The maximum towable load must be reduced by 10% per 1,000 metres of altitude.

i Use genuine towing devices and wiring harnesses approved by PEUGEOT. We

recommend having them fitted by a PEUGEOT dealer or a qualified workshop. If not fitted by a PEUGEOT dealer, they must still be fitted in accordance with the vehicle manufacturer's instructions.

Certain driving or manoeuvring aid functions are automatically deactivated while an approved towing system is in use.

For more information about driving with a towing device fitted to a trailer and associated with the **Trailer stability assist**, refer to the corresponding section.

! Comply with the maximum authorised towable weight, as indicated on your vehicle's registration certificate, on the manufacturer's label and in the **Technical data** section of this guide.

! If using accessories attached to the towing device (e.g. bicycle carriers, tow boxes):

- Comply with the maximum authorised nose weight.
- Do not transport more than 4 conventional bicycles or 2 electric bicycles.

When loading bicycles onto a bicycle carrier on a towball, be sure to place the heaviest bicycles as close as possible to the vehicle.

! Observe the legislation in force in the country where you are driving.

i Electric motor

An electric vehicle cannot under any circumstances be fitted with a towing device. It is therefore not possible to tow a trailer or caravan.

Towing device with quickly detachable towball

Presentation

No tools are required to install or remove this genuine towing device.

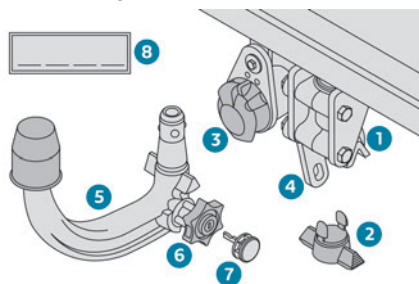

1. Carrier
2. Protective plug
3. Connection socket
4. Safety eye
5. Detachable towball
6. Locking/unlocking wheel
7. Security key lock

8. Label to note the key references

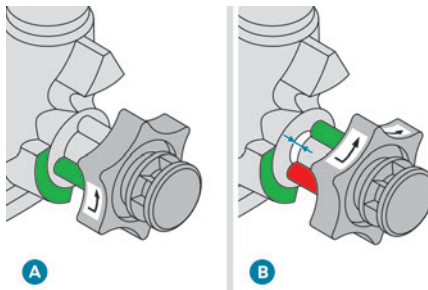

- A. Locked** position (the **green** marks are opposite each other); the wheel is in contact with the towball (no gap).
- B. Unlocked** position (**red** mark opposite the **green** mark); the wheel is no longer in contact with the towball (gap of around 5 mm).

i Affix the enclosed label in a clearly visible location, close to the carrier or in the boot.

! Trailers with LED lamps are not compatible with the wiring harness of this device.

i To ensure complete safety while driving with a **Towing device**, refer to the corresponding section.

! Before each use

Verify that the towball is correctly fitted, checking the follow points:

- The green mark on the wheel is in line with the green mark on the towball.
- The wheel is in contact with the towball (position **A**).
- The security key lock is closed and the key removed; the wheel can no longer be operated.
- The towball must not be able to move in its carrier; test by attempting to shake it with your hand.

If the towball is not locked, the trailer can become detached - risk of an accident!

! During use

Never release the locking system with a trailer or load carrier on the towball. Never exceed the maximum authorised weight for the vehicle - the Gross Train Weight or GTW. Always comply with the maximum authorised load on the towing device: if it is exceeded, this device may become detached from the vehicle - risk of an accident! Before driving, check the headlamp height adjustment and check that the lamps on the trailer operate correctly. For more information on **Headlamp height adjustment**, refer to the corresponding section.

! After use

When travelling without a trailer or load carrier, remove the towball and fit the protective plug into the carrier, to provide clear visibility of the number plate and/or its lighting.

Maintenance

Correct operation is only possible if the towball and its carrier are kept clean. Before cleaning the vehicle with a high-pressure jet wash, the towball must be removed and the protective plug fitted to the carrier.

i Work on the towing device

Contact a PEUGEOT dealer or a qualified workshop.

Fitting the towball

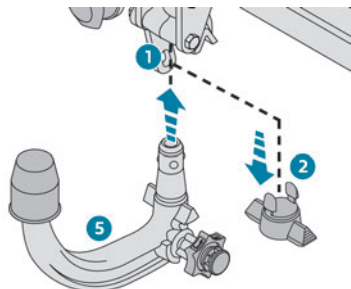

- ▶ Below the rear bumper, remove the protective plug **2** from the carrier **1**.
- ▶ Insert the end of the towball **5** into the carrier **1** and push it upwards; it will lock into position automatically.

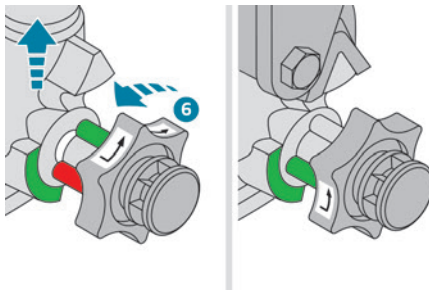

- ▶ The wheel **6** rotates a quarter turn anti-clockwise; take care to keep your hands clear!

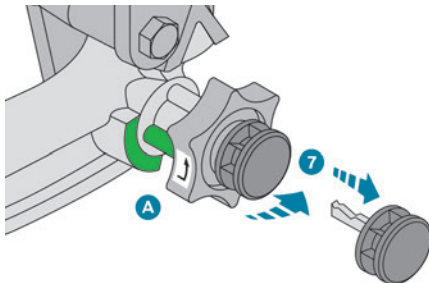

- ▶ Check that the mechanism has correctly locked into place (position **A**).
- ▶ Close the lock **7** using the key.

- ▶ Remove the key. The key cannot be removed while the lock is open.
- ▶ Clip the cap onto the lock.

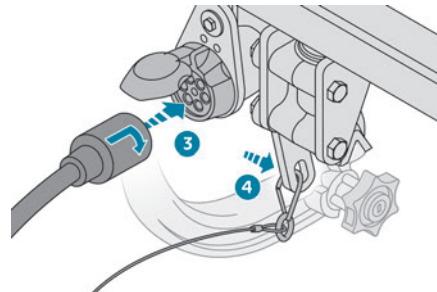

- ▶ Remove the protective cover from the towball.
- ▶ Attach the trailer to the towball.
- ▶ Attach the cable on the trailer to the safety eye **4** on the carrier.
- ▶ Insert the trailer plug and rotate it by a quarter turn to connect it to the connection socket **3** on the carrier.

Removing the towball

- ▶ Grasp the trailer's plug, perform a quarter turn and pull to disconnect it from the connection socket **3** on the carrier.
- ▶ Detach the trailer's safety cable from the safety eye **4** on the carrier.
- ▶ Unhitch the trailer from the towball.
- ▶ Replace the protective cover over the towball.

- ▶ Remove the cap from the lock and press it onto the head of the key.

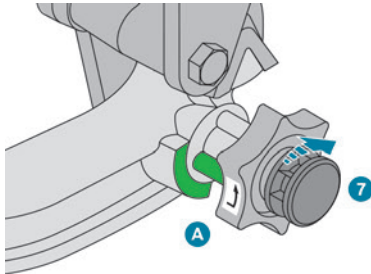

- ▶ Insert the key into the lock 7.
- ▶ Open the lock using the key.

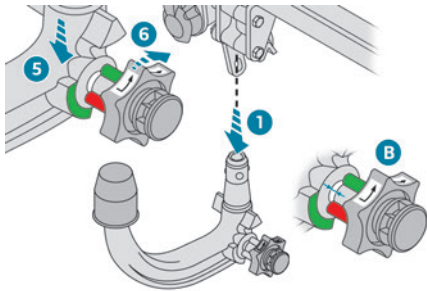

- ▶ Hold the towball 5 firmly in one hand; using the other hand, pull and turn the wheel 6 fully in a clockwise direction until it stops; do not release the wheel.
- ▶ Extract the towball from the base of its carrier 1.

- ▶ Release the wheel; it automatically locks in the unlocked position (position B).

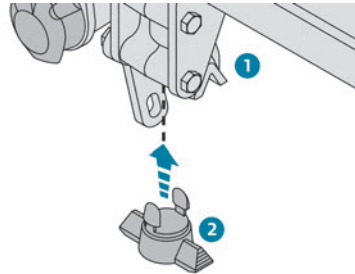

- ▶ Replace the protective plug 2 into the carrier 1.
- ▶ Stow the towball in its bag to protect it from knocks and dirt.

Roof bars

- ! As a safety measure and to avoid damaging the roof, it is essential to use transverse roof bars approved for your vehicle.
- Observe the instructions on fitting and use contained in the guide supplied with the roof bars.

- ! Maximum load distributed over the roof bars, for a loading height not exceeding 40 cm: **70 kg**.

As this value may change, please verify the maximum load quoted in the guide supplied with the roof bars.

If the height exceeds 40 cm, adapt the speed of the vehicle to the profile of the road to avoid damaging the roof bars and the fixings on the vehicle.

Be sure to refer to national legislation in order to comply with the regulations for transporting objects that are longer than the vehicle.

! Recommendations

Distribute the load uniformly, taking care to avoid overloading one of the sides. Arrange the heaviest part of the load as close as possible to the roof. Secure the load firmly. Drive gently: the vehicle will be more susceptible to the effects of side winds and its stability may be affected. Regularly check the security and tight fastening of the roof bars, at least before each trip. Remove the roof bars once they are no longer needed.

! Sunroof

Check that the load does not protrude below the roof bars, so that it does not

impede movement of the sunroof - risk of major damage!

Fitting on longitudinal bars

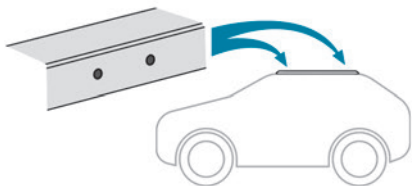

The transverse bars must be fixed at the markings located on the longitudinal bars.

Direct fitting on roof

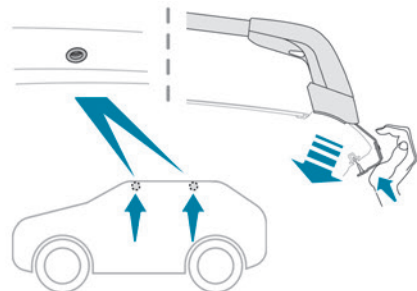

The transverse bars must only be fixed at the four anchorage points located on the roof frame. These points are concealed by the vehicle doors when the doors are closed.

The roof bar fixings have a stud which must be inserted into the opening of each anchorage point.

Snow chains

In wintry conditions, snow chains improve traction as well as the behaviour of the vehicle when braking.

! Snow chains must be fitted only to the front wheels.

They must never be fitted to "space-saver" type spare wheels.

i Observe the legislation in force in your country relating to the use of snow chains and maximum authorised speeds.

Only use chains that have been designed to be fitted on the type of wheel on the vehicle:

Original tyre size	Maximum link size
215/65R16	9 mm (Polaire XP9)
215/60R17	9 mm (Polaire XP9)
215/55R18	10 mm (Polaire 0112)

For more information on snow chains, contact a PEUGEOT dealer or a qualified workshop.

Installation tips

- ▶ To fit the snow chains during a journey, stop the vehicle on a flat surface at the side of the road.
- ▶ Apply the parking brake and position any wheel chocks under the wheels to prevent movement of the vehicle.
- ▶ Fit the snow chains following the instructions provided by the manufacturer.
- ▶ Move off gently and drive for a few moments, without exceeding 31 mph (50 km/h).
- ▶ Stop the vehicle and check that the snow chains are correctly tightened.

i It is strongly recommended that you practise fitting the snow chains on a level and dry surface before setting off.

! Avoid driving with snow chains on roads that have been cleared of snow to avoid damaging the vehicle's tyres and the road surface. If the vehicle is fitted with alloy wheels, check that no part of the chain or its fixings is in contact with the wheel rim.

Very cold climate screen

(Depending on country of sale)
This removable device prevents the accumulation of snow around the radiator cooling fan.

It consists of a first element for the upper part of the front grille and a second element for the lower part.

I In case of difficulty with installation/removal

Contact a PEUGEOT dealer or a qualified workshop.

! Before any operation, ensure that the engine is off and the cooling fan has stopped.

! It is essential to remove them when:

- the outside temperature exceeds 10°C.
- recovery is in progress.
- the speed is above 75 mph (120 km/h).

Fitting

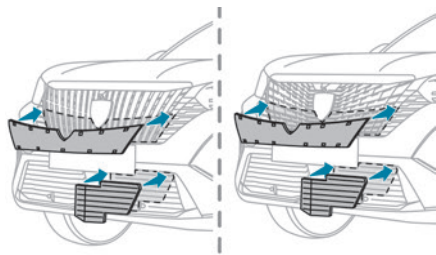

► Hold the side screen in front of the lower left grille of the bumper.

- First insert the lower fixing brackets into the bumper.
 - Tilt the side screen upwards until the side and then upper fixing brackets click into the bumper.
 - Check that the unit is firmly held by pressing around the edges.
- Repeat the same process to fit the central screen into the upper grille of the bumper.

Removing

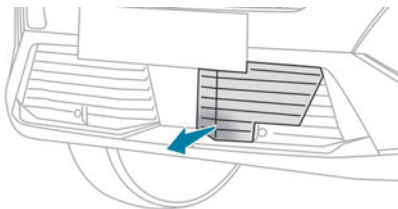

For the side screen

- Insert a finger into the notch in the lower part of the side screen.
- Pull towards you to unclip the unit.

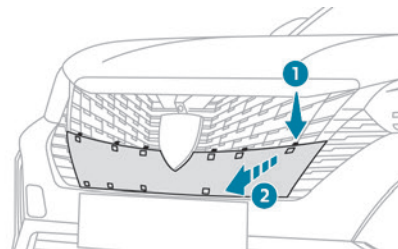

For the central screen with horizontal grille

- Press the upper fixing brackets to release them from the grille.
- Gently tilt the central screen downwards.
- Pull towards you to unclip the unit.

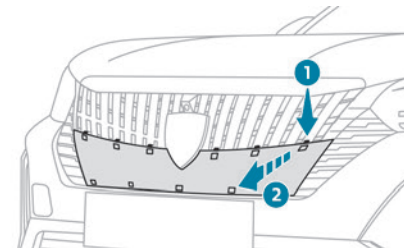

For the central screen with vertical grille

- Insert a flat screwdriver into the holes to reach the upper fixing brackets of the central screen.
- Press on each upper fixing bracket in turn to release them from the grille.
- Pull towards you to unclip the unit.

Energy economy mode

This system manages the duration of use of certain functions, in order to conserve a sufficient level of charge in the battery with the ignition off. After switching off the engine and for a maximum cumulative period of around 30 minutes, you can continue to use functions such as the audio and telematics system, dipped beam headlamps or courtesy lamps.

Selecting the mode

A confirmation message is displayed when energy economy mode is entered, and the active functions are placed on standby.

I If a telephone call is in progress at the time, it will be maintained for around 10 minutes via the audio system's hands-free system.

Exiting the mode

These functions are automatically reactivated the next time the vehicle is used.

To restore the use of these functions immediately, start the engine and let it run:

- For less than 10 minutes, to use the equipment for approximately 5 minutes.
- For more than 10 minutes, to use the equipment for approximately 30 minutes.

Let the engine run for the specified duration to ensure that the battery charge is sufficient. To recharge the battery, avoid repeatedly or continuously restarting the engine.

! A flat battery prevents the engine from starting.

For more information on the **12 V battery**, refer to the corresponding section.

Load reduction mode

This system manages the use of certain functions according to the level of charge remaining in the battery.

When the vehicle is being driven, the load reduction function temporarily deactivates certain functions, such as the air conditioning and the heated rear screen.

The deactivated functions are reactivated automatically as soon as conditions permit.

Bonnet

! Stop & Start

Before doing anything under the bonnet, you must switch off the ignition to avoid any risk of the engine restarting automatically. Take care with objects or clothing that could be caught in the blades of the cooling fan or in certain moving components - risk of strangulation and serious injury!



! Electric motor

Take care with objects or clothing that could be caught in the blades of the cooling fan or in certain moving components - risk of strangulation and serious injury!

Before carrying out any work under the bonnet, you must switch off the ignition, check that the **READY** indicator lamp is off on the instrument panel and disconnect the nozzle from the charging connector if it is connected.

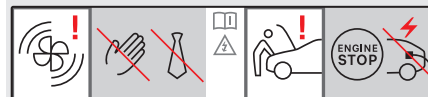

I The location of the interior bonnet release lever prevents the bonnet being opened when the left-hand front door is closed.

! When the engine is hot, handle the exterior safety catch and the bonnet stay with care (risk of burns), using the protected area. When the bonnet is open, take care not to damage the safety catch. Do not open the bonnet under very windy conditions.

! **Cooling of the engine when stopped**
The engine cooling fan may start after the engine has been switched off. Take care with objects or clothing that could be caught in the blades of the fan!

Opening

- ▶ Open the left-hand front door.

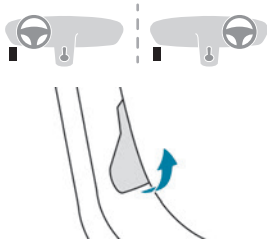

- ▶ Pull the interior release lever, located at the bottom of the door frame, towards you.

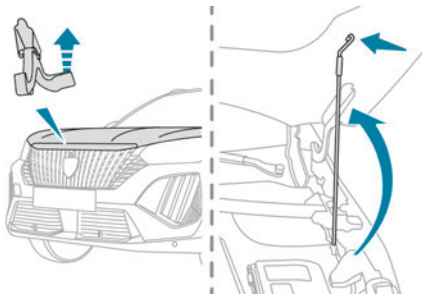

- ▶ Lift the exterior safety catch and raise the bonnet.
- ▶ Unclip the stay from its housing and place it in the support slot to hold the bonnet open.

Closing

- ▶ Hold the bonnet and pull out the stay from the support slot.
- ▶ Clip the stay in its housing.
- ▶ Lower the bonnet and release it near the end of its travel.
- ▶ Pull on the bonnet to check that it is locked correctly.

! Because of the presence of electrical equipment under the bonnet, it is strongly recommended that exposure to water (rain, washing, etc.) be limited.

Engine compartment

The engine shown here is an example for illustrative purposes only.

The locations of the following components may vary:

- Air filter.
- Engine oil dipstick.
- Engine oil filler cap.

Petrol engine

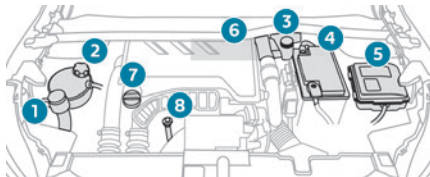

Diesel engine

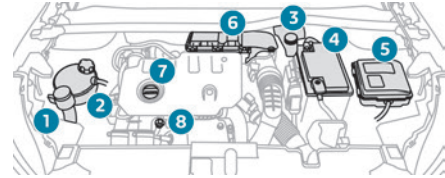

1. Screenwash fluid reservoir
2. Engine coolant reservoir
3. Brake fluid reservoir
4. Battery/Fuses
5. Fusebox
6. Air filter
7. Engine oil filler cap
8. Engine oil dipstick

! Diesel fuel system

This system is under very high pressure. All work must be carried out only by a PEUGEOT dealer or a qualified workshop.

Electric motor

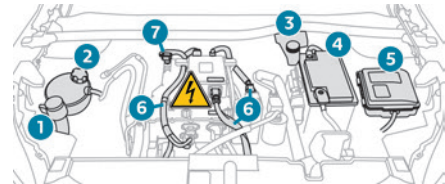

1. Screenwash fluid reservoir
2. Engine coolant reservoir (level only)

3. Brake fluid reservoir
4. Battery/Fuses
5. Fusebox
6. 400 V electrical circuit
7. Emergency circuit-breaker for emergency services and maintenance technicians

For more information on the **Charging system (Electric)**, refer to the corresponding section.

Checking levels

Check all of the following levels regularly in accordance with the Manufacturer's service schedule. Top them up if required, unless otherwise indicated.

If a level drops significantly, have the corresponding system checked by a PEUGEOT dealer or a qualified workshop.

! The fluids must comply with the Manufacturer's requirements and with the vehicle's engine.

! Take care when working under the bonnet, as certain areas of the engine may be extremely hot (risk of burns) and the cooling fan could start at any time (even with the ignition off).

Used products

! Avoid prolonged contact of used oil or fluids with the skin.

Most of these fluids are harmful to health and very corrosive.



Do not discard used oil or fluids into sewers or onto the ground.

Empty used oil into the containers reserved for this purpose at a PEUGEOT dealer or a qualified workshop.

Engine oil



The level is checked, with the engine having been switched off for at least 30 minutes and on level ground, either using the oil level indicator in the instrument panel when the ignition is switched on (for vehicles equipped with an electric gauge), or using the dipstick. It is normal to top up the oil level between two services (or oil changes). It is recommended that you check the level, and top up if necessary, every 3,000 miles (5,000 km).

! In order to maintain the reliability of the engine and emissions control system, never use additives in the engine oil.

Checking using the dipstick

For the location of the dipstick, please refer to the illustration of the corresponding engine compartment.

- ▶ Grasp the dipstick by its coloured grip and pull it out completely.
- ▶ Wipe the end of the dipstick using a clean, lint-free cloth.

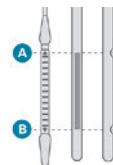

- ▶ Reinsert the dipstick and push fully down, then pull it out again to visually check the oil level: the correct level is between marks **A (max)** and **B (min)**.

Do not start the engine if the level is:

- above mark **A**: contact a PEUGEOT dealer or a qualified workshop.
- below mark **B**: top up the engine oil immediately.

! Oil grade

Before topping up or changing the engine oil, check that the oil is suitable for your engine and complies with the recommendations in the service schedule supplied with the vehicle (or available from your PEUGEOT dealer or qualified workshop).

Use of non-recommended oil may invalidate your warranty in the event of engine failure.

Topping up the engine oil level

For the location of the engine oil filler cap, please refer to the corresponding engine compartment illustration.

- ▶ Add oil in small quantities, avoiding any spills on engine components (risk of fire).
- ▶ Wait a few minutes before checking the level again using the dipstick.
- ▶ Top up the level if necessary.
- ▶ After checking the level, carefully screw the oil filler cap back on and replace the dipstick in its tube.

i The oil level indication displayed on the instrument panel when the ignition is switched on is not valid for 30 minutes following an addition of oil.

Brake fluid



The level of this fluid should be close to the "**MAX**" mark. If not, check the brake pads for wear.

To know how often the brake fluid should be replaced, refer to the manufacturer's servicing schedule.

! Clean the cap before removing it to refill. Use only DOT4 brake fluid from a sealed container.

Engine coolant

(Petrol or Diesel)



It is normal to top up this fluid between two services.

The check and top-up must only be done with the engine cold.

A level of coolant that is too low risks causing major damage to the engine; the coolant level must be close to the "**MAX**" mark without ever going above it.

If the level is close to or below the "**MIN**" mark, it is essential to top it up.

When the engine is hot, the temperature of the coolant is regulated by the fan.

As the cooling system is pressurised, wait at least one hour after switching off the engine before carrying out any work.

In order to avoid the risk of scalding if you need to top up in an emergency, wrap a cloth around the cap and unscrew the cap by two turns to allow the pressure to drop.

Once the pressure has dropped, remove the cap and top up to the required level.



Vehicle with electric motor



Do not top up the coolant.



If the level is close to or below the "**MIN**" mark, it is essential to contact a PEUGEOT dealer or a qualified workshop.

Screenwash fluid



Top up to the required level when necessary.

Fluid specification

The fluid must be topped up with a pre-mixed product.

In winter (temperatures below zero), a fluid containing an anti-freeze agent which is appropriate for the temperature conditions must be used in order to protect the system's components (pump, tank, ducts, jets).



Filling with pure water is prohibited in all circumstances (risk of freezing, limescale, etc.).

AdBlue® (BlueHDi)

An alert is triggered when the reserve level is reached.

For more information on the **Indicators** and in particular the AdBlue range indicators, refer to the corresponding section.

To avoid the vehicle being immobilised in accordance with regulations, you must top up the AdBlue tank.

For more information on **AdBlue® (BlueHDI)**, and in particular the supply of AdBlue, refer to the corresponding section.

Checks

Unless otherwise indicated, check these components in accordance with the Manufacturer's service schedule and according to your engine.

Otherwise, have them checked by a PEUGEOT dealer or a qualified workshop.

! Only use products recommended by PEUGEOT or products of equivalent quality and specification. In order to optimise the operation of components as important as those in the braking system, PEUGEOT selects and offers very specific products.

12 V battery



The battery does not require any maintenance.

Check regularly that the terminals are correctly tightened (versions without quick-release terminals) and that the connections are clean.

i For more information on the precautions to take before any work on the **12 V battery**, refer to the corresponding section.

! Versions equipped with Stop & Start are fitted with a 12 V lead-acid battery with special technology and specifications. Its replacement should be carried out only by a PEUGEOT dealer or a qualified workshop.

Passenger compartment filter



Depending on the environment and the use of the vehicle (e.g. dusty atmosphere, city driving), **change it twice as often, if necessary.**

i A clogged passenger compartment filter can adversely affect air conditioning system performance and generate undesirable odours.

Air filter



Depending on the environment and the use of the vehicle (e.g. dusty atmosphere, city driving), **change it twice as often, if necessary.**

Oil filter



Change the oil filter each time the engine oil is changed.

Particle filter (Diesel)



The start of clogging of the particle filter is indicated by the

temporary lighting of this warning lamp, accompanied by an alert message. As soon as traffic conditions allow, regenerate the filter by driving at a speed of at least 37 mph (60 km/h), with an engine speed above 2,500 rpm, for about 15 minutes (until the warning lamp goes out).

If it is not possible to reach 37 mph (60 km/h), leave the engine running at idle for about 15 minutes, then drive with an engine speed above 2,500 rpm for 15 minutes.

! Do not switch off the engine until the filter is fully regenerated; repeated intervals can degrade the engine oil prematurely. Regenerating the filter while the vehicle is stationary is not recommended.

i Following prolonged operation of the vehicle at very low speed or at idle, you may, in exceptional circumstances, notice water vapour coming from the exhaust while accelerating. These emissions have no impact on the vehicle's behaviour and the environment.

i **New vehicle**
During the first few particle filter regeneration operations, you may notice a "burning" smell. This is perfectly normal.

Manual gearbox



The gearbox does not require any maintenance (no oil change).

Automatic gearbox



The gearbox does not require any maintenance (no oil change).

Manual parking brake



If you notice excessive brake lever travel or decreased effectiveness, the parking brake must be adjusted, even between two services.

This system must be checked by a PEUGEOT dealer or a qualified workshop.

Electric parking brake



This system does not require any routine servicing. However, in the event of a problem, do not hesitate to have the system checked by a PEUGEOT dealer or a qualified workshop.

i For more information on the **Electric parking brake**, refer to the corresponding section.

Brake pads



Brake wear depends on the style of driving, particularly in the case of vehicles used in town, over short distances. It may be

necessary to have the condition of the brakes checked, even between vehicle services. Unless there is a leak in the circuit, a drop in the brake fluid level indicates that the brake pads are worn.

i After washing the vehicle, moisture, or in wintry conditions, ice can form on the brake discs and pads: braking efficiency may be reduced. Gently dab the brakes to dry and defrost them.

Brake disc/drum wear



For any information on checking brake disc/drum wear, contact a PEUGEOT dealer or a qualified workshop.

Wheels and tyres



The inflation pressure of all tyres, including the spare wheel, must be checked on "cold" tyres. The pressures indicated on the tyre pressure label are valid for "cold" tyres. If you have driven for more than 10 minutes or more than 6 miles (10 kilometres) at over 31 mph (50 km/h), add 0.3 bar (30 kPa) to the values indicated on the label.

! Under-inflation increases energy consumption. Non-compliant tyre pressures cause tyres to wear prematurely and have an adverse effect on the vehicle's road holding - risk of accident!

Driving with worn or damaged tyres reduces the braking and road holding performance of the vehicle. Regularly check the condition of the tyres (tread and sidewalls) and rims as well as the presence of the valve caps.

When the wear indicators no longer appear set back from the tread, the depth of the grooves is less than 1.6 mm; replace the tyres as soon as possible.

Using different size wheels and tyres from those specified can affect the lifetime of tyres, wheel rotation, ground clearance, the speedometer reading and have an adverse effect on road holding.

Fitting different size tyres on the front and rear axles can cause the ESC to mistime.

Always mark the direction of rotation on the tyres that will be stored when fitting winter or summer tyres. Store them in a cool, dry place and away from direct exposure to the sun's rays.



Winter or 4-seasons tyres can be identified by this symbol on their sidewalls.

Shock absorbers



It is not easy for drivers to detect when shock absorbers are worn. Nevertheless, the shock absorbers have a major impact on road holding and braking performance.

For your safety and driving comfort, it is important to have them regularly checked by a PEUGEOT dealer or a qualified workshop.

Timing and accessory kits



The timing and accessory kits are used from the time the engine is started until it is switched off. It is normal for them to wear over time.

A faulty timing or accessory kit can damage the engine, rendering it unusable. Observe the recommended replacement frequency, stated in distance travelled or time elapsed, whichever is reached first.

AdBlue® (BlueHDi)

To respect the environment and ensure compliance with the Euro 6 standard, without adversely affecting the performance or fuel consumption of its Diesel engines, PEUGEOT has taken the decision to equip its vehicles with a system that combines SCR (Selective Catalytic Reduction) with a Diesel Particle Filter (DPF) for the treatment of exhaust gases.

SCR system

Using a liquid called AdBlue® that contains urea, a catalytic converter turns up to 85% of the nitrogen oxides (NOx) into nitrogen and water, which are harmless to health and the environment.



The AdBlue® is contained in a **special tank** holding about 15 litres. Its capacity allows a driving range of approximately 4,000 miles (6,500 km) before an

alert, **which may vary considerably** depending on your driving style.

An alert system is triggered once the reserve level is reached: it is then possible to drive for a further 1,500 miles (2,400 km) before the tank is empty and the vehicle is immobilised.

i For more information on the **Warning and indicator lamps** and the associated alerts, or the **Indicators**, please refer to the corresponding sections.

! Once the AdBlue® tank is empty, a device required by law prevents the engine from being restarted.

If the SCR system is faulty, the level of emissions from the vehicle will no longer meet the Euro 6 standard and the vehicle starts polluting the environment.

In the event of a confirmed SCR system malfunction, it is essential to visit a PEUGEOT dealer or a qualified workshop as soon as possible. After 685 miles (1,100 km), a device is automatically activated to prevent the engine from starting.

In both cases, a range indicator indicates the distance that can be travelled before the vehicle is immobilised.

i **Freezing of the AdBlue®**
AdBlue® freezes at temperatures below around -11°C.

The SCR system includes a heater for the AdBlue® tank, allowing you to continue driving in very cold conditions.

Supply of AdBlue®

It is recommended that the AdBlue® be topped up as soon as the first alert is issued indicating that the reserve level has been reached.

- !** For the correct operation of the SCR system:
- Use only AdBlue® fluid that meets the ISO 22241 standard.
 - Never transfer AdBlue® to another container as it would lose its purity.
 - Never dilute AdBlue® with water.

You can obtain AdBlue® from a PEUGEOT dealer or a qualified workshop, as well as service stations equipped with AdBlue® pumps specially designed for passenger vehicles.

Recommendations on storage

AdBlue® freezes at about -11°C and deteriorates above +25°C. Containers should be stored in a cool area and protected from direct sunlight. Under these conditions, the fluid can be kept for at least a year.

If the fluid has frozen, it can be used once it has completely thawed out at room temperature.

- !** Never store AdBlue® containers in your vehicle.

Precautions for use

AdBlue® is a urea-based solution. This fluid is non-flammable, colourless and odourless (when kept in a cool place).

In the event of contact with the skin, wash the affected area with soap and running water. In the event of contact with the eyes, immediately rinse the eyes with large amounts of water or with an eye wash solution for at least 15 minutes. Seek medical attention if you feel a persistent burning sensation or irritation.

If swallowed, immediately wash out the mouth with clean water and then drink plenty of water. In certain conditions (high temperature, for example), the risk of release of ammonia cannot be excluded: do not inhale the fluid. Ammonia vapours have an irritant effect on mucous membranes (eyes, nose and throat).

- ! Store AdBlue® out of the reach of children, in its original container.

Procedure

Before starting the top-up procedure, ensure that the vehicle is parked on a flat and level surface. In wintry conditions, ensure that the temperature of the vehicle is above -11°C. Otherwise the AdBlue® may be frozen and so cannot be poured into the tank. Park the vehicle in a warmer area for a few hours to allow the top-up to be carried out.

- ! Never pour the AdBlue® into the Diesel fuel tank.

- ! If any AdBlue® is splashed, or if there are any spillages on the bodywork, rinse immediately with cold water or wipe with a damp cloth.
If the fluid has crystallised, clean it off using a sponge and hot water.

- ! Important: in the event of a top-up after a breakdown because of a lack of AdBlue, it is essential to wait around 5 minutes before switching on the ignition, **without opening the driver's door, unlocking the vehicle, inserting the key into the ignition switch, or bringing the key to the "Keyless Entry and Start" system into the passenger compartment.** Switch on the ignition, then wait for 10 seconds before starting the engine.

- ▶ Switch off the ignition and remove the key from the switch to switch off the engine. or
- ▶ With the Keyless Entry and Start system, press the "START/STOP" button to switch off the engine.

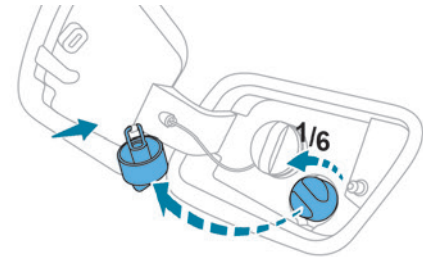

- ▶ Turn the blue cap of the AdBlue® tank anti-clockwise and remove it.
- ▶ With a container of AdBlue®: after checking the expiry date, read the instructions on the label carefully before pouring the contents of the container into the vehicle's AdBlue® tank.
- ▶ With an AdBlue® pump: insert the nozzle and fill the tank until the nozzle automatically cuts out.

- ! In order not to overfill the AdBlue® tank:
 - Add between 10 and 13 litres using AdBlue® containers.
 - Stop after the nozzle's first automatic cut-out, if you are refilling at a service station. The system only registers AdBlue® intermediate top-ups of 5 litres or more.

- ! If the AdBlue® tank is completely empty
 - which is confirmed by the message

“Top up AdBlue: Starting impossible” – it is essential to add at least 10 litres. Top-up detection may not be instantaneous after addition. It may take a few minutes of driving before the top-up detection is effective.

Free-wheeling

In certain situations, it is necessary to put the vehicle into free-wheeling mode (e.g. towing, on a rolling road, automatic car wash (Wash mode), rail or sea transport).

The procedure varies according to the type of gearbox and parking brake.

 Never leave the vehicle unattended with the vehicle into free-wheeling mode.

Keyless Entry and Start

You must not depress the brake pedal while switching the ignition on again, then switching it off. If you do, the engine will start, requiring you to restart the procedure.

With manual or EAT6 automatic gearbox and electric parking brake



To release them

- ▶ With the engine running and while depressing the brake pedal, move the gear selector to the neutral position.
- ▶ While depressing the brake pedal, switch off the engine.
- ▶ Release the brake pedal, then switch on the ignition.
- ▶ While depressing the brake pedal, press the control to release the parking brake.
- ▶ Release the brake pedal, then switch off the ignition.

Reverting to normal operation

- ▶ While depressing the brake pedal, restart the engine and apply the parking brake.

With EAT8 automatic gearbox and manual parking brake



Release procedure

- ▶ With the vehicle stationary and the engine running, select mode **N** and switch off the engine.

Within 5 seconds:

- ▶ Switch on the ignition.
- ▶ While depressing the brake pedal, move the push selector forwards or backwards to confirm mode **N**.

- ▶ Switch off the ignition.

 If the 5-second time limit is exceeded, the gearbox engages mode **P**; it is then necessary to restart the procedure.

Reverting to normal operation

- ▶ Press button **P** on the selector.

With EAT8 automatic gearbox or drive selector and electric parking brake



Release procedure

- ▶ With the vehicle stationary and the engine running, depress the brake pedal and select mode **N**.

Within 5 seconds:

- ▶ Depress and hold the brake pedal, then observe this order: switch off the engine and move the push selector forwards or backwards.
- ▶ Release the brake pedal, then switch on the ignition.
- ▶ Place your foot on the brake and press the electric parking brake control to release it.
- ▶ Release the brake pedal, then switch off the ignition.

! A message is displayed on the instrument panel to confirm the unlocking of the wheels for 15 minutes. When the vehicle is free-wheeling, the audio system cannot be updated (message displayed on the instrument panel).

After 15 minutes or reverting to normal operation

▶ While depressing the brake pedal, restart the engine and select mode **P**.

Advice on care and maintenance

General recommendations

Observe the following recommendations to avoid damaging the vehicle.

Exterior

! Never use a high-pressure jet wash in the engine compartment - risk of damaging the electrical components! Do not wash the vehicle in bright sunshine or extremely cold conditions.

i When washing the vehicle in an automatic roller-brush car wash, be sure

to lock the doors and, depending on version, move the electronic key away. When using a pressure washer, keep the jet nozzle at a minimum distance of 30 cm from the vehicle (particularly when cleaning areas containing chipped paint, sensors or seals). Promptly clean up any stains containing chemicals liable to damage the vehicle's paintwork (including tree resin, bird droppings, insect secretions, pollen and tar). Depending on the environment, clean the vehicle frequently to remove salty deposits (in coastal areas), soot (in industrial areas) and mud/salts (in wet or cold areas). These substances can be highly corrosive. Contact a PEUGEOT dealer or a qualified workshop for advice on removing stubborn stains requiring special products (such as tar or insect removers). Preferably, have paint touch-ups performed by a PEUGEOT dealer or a qualified workshop.

Interior

! When washing the vehicle, never use a water hose or high-pressure jet to clean the interior. Liquids carried in cups or other open containers can spill, presenting a risk of damage to the instruments and controls and the controls located on the centre console. Be vigilant!

To clean instrument panels, touch screens or other displays, wipe gently with a soft, dry cloth. Do not use products (e.g. alcohol, disinfectant) or soapy water directly on these surfaces - risk of damage!

Bodywork

High-gloss paint

! Do not use abrasive products, solvents, petrol or oil to clean the bodywork.

Never use an abrasive sponge to clean stubborn stains - risk of scratching the paintwork!

Do not apply polish in strong sunshine, or to plastic or rubber parts.

i Use a soft cloth and soapy water or a pH neutral product.

Gently wipe the bodywork with a clean microfibre cloth.

Apply polish with the vehicle clean and dry. Comply with the instructions for use stated on the product.

Decals

(Depending on version)

! Do not use a high-pressure washer to clean the vehicle - risk of damaging or detaching the decals!

- Use a high-flow hose (temperature between 25°C and 40°C).

Place the jet of water perpendicular to the surface to be cleaned.

Rinse the vehicle with demineralised water.

Textile

The dashboard, door panels and seats may contain parts made of textile material.

Maintenance

- Do not use aggressive cleaning products (e.g. alcohol, solvent or ammonia).

Do not use steam-cleaning systems - risk of affecting the adhesion of the fabrics!

- Remove dust from the textile parts regularly with a dry cloth, soft brush or vacuum cleaner.

Rub down the textile parts once per year with a clean, damp cloth. After leaving overnight to dry, brush with a soft-bristled brush.

Stain removal

- Do not rub the stain or it may spread or you may cause the substance to penetrate the surface.

- Act quickly by reducing the stain from its edges inwards.

Remove as much substance or solids as possible using a spoon or spatula, and remove as much liquid as possible using absorbent paper.

Product/Procedure to use depending on the type of stain:

- Grease, oil and ink: clean with a pH-neutral detergent.
 - Vomit: clean with sparkling mineral water.
 - Blood: spread flour over the stain and allow to dry; remove with a slightly damp cloth.
 - Mud: allow to dry and then remove with a slightly damp cloth.
 - Cake, chocolate, ice cream: clean with lukewarm water.
 - Sugary and/or alcoholic drinks: clean with lukewarm water, or lemon juice if the stain is persistent.
 - Hair gel, coffee, tomato sauce, vinegar: clean with lukewarm water and lemon juice.
- For solid substances, then use a soft brush or vacuum cleaner.
- For liquid substances, then use a damp microfibre cloth and then dry with another cloth.

Alcantara®

Alcantara® is an elegant and practical material which is very resistant and easy to maintain.

- Do not use printed cloths or printed absorbent paper.

Do not use steam-cleaning systems.

- Remove dust from the Alcantara® parts regularly with a dry cloth, soft brush or vacuum cleaner.

Clean the Alcantara®, without rubbing too vigorously, with a white cotton cloth which is slightly damp.

To find out which products and procedures to use on different types of stains, refer to the "Textile - Stain removal" section.

For more information, go to the Alcantara® trademark website: www.alcantara.com.

Leather

Leather is a natural product. Appropriate regular care is essential for its durability.

It must be protected and nourished using a specific leather product, to keep it supple and preserve its original appearance.

- Do not use maintenance products which are not suitable for cleaning leather (e.g. solvent, detergent, petrol, pure alcohol). Do not use bleaching or colour-removal products (e.g. perchloroethylene). When cleaning items partly made from leather, take care not to damage the other materials with the specific leather product.

i Before cleaning greasy stains or liquids, quickly mop up any surplus.

Before cleaning, wipe off any residues liable to scuff the leather, using a cloth that has been dampened with demineralised water and thoroughly wrung out.

Clean the leather, without rubbing too vigorously, using a soft cloth moistened with soapy water or a pH-neutral product. Dry with a soft, dry cloth.

Warning triangle

This reflective and dismantable device is to be installed on the side of the road when a vehicle is broken down or damaged.

! Before getting out of the vehicle

Turn on the hazard warning lamps, then put on the safety vest to assemble and install the triangle.

Storage compartment

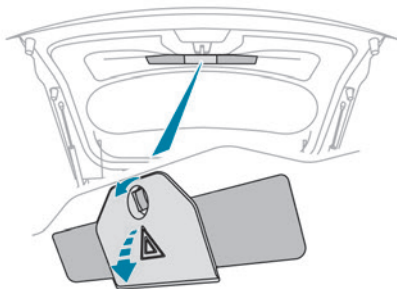

There is a compartment in the interior trim of the tailgate to store a warning triangle.

► After opening the tailgate, release the cover by turning the screw a quarter turn to the left.

Assembling and placing the triangle

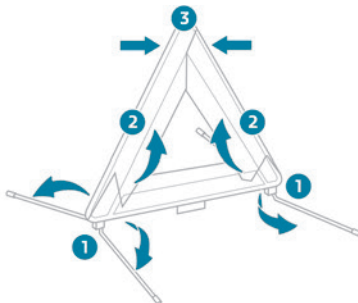

For versions supplied with a triangle as original equipment, refer to the illustration above.

For other versions, refer to the assembly instructions provided with the triangle.

► Put the triangle in place behind the vehicle, as required by local legislation.

Running out of fuel (Diesel)

With Diesel engines, the fuel system must be primed if you run out of fuel.

Before starting to prime the system, it is essential to put at least 5 litres of Diesel into the fuel tank.

i For more information on **Refuelling** and on **Misfuel prevention (Diesel)**, refer to the corresponding section.

1.5 BlueHDi engines

- Switch on the ignition (without starting the engine).
 - Wait around 1 minute and switch off the ignition.
 - Operate the starter motor to start the engine.
- If the engine does not start at the first attempt, do not keep trying, but restart the procedure.

Tool kit

Set of tools supplied with the vehicle.

Its content depends on your vehicle's equipment:

- Temporary puncture repair kit.
- Spare wheel.

! These tools are specific to the vehicle and may vary according to the level of equipment.

Do not use them for any other purpose.

Access to the tools

Depending on version, the tool kit is stored in a bag or in a storage box in the boot.

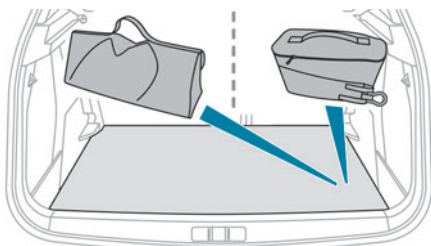

On the boot carpet or floor

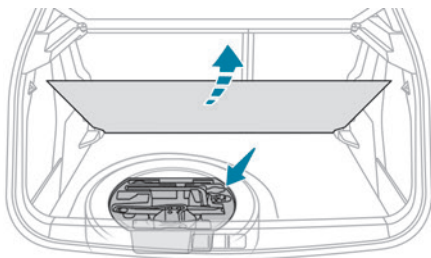

Under the boot carpet or floor

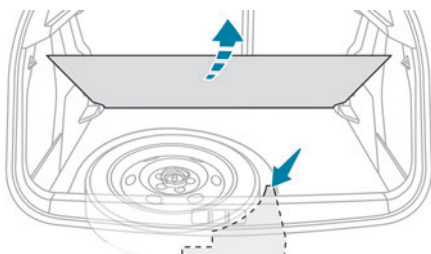

- Raise the boot floor (depending on version), then the boot carpet by pulling the strap to access the tools.

List of tools

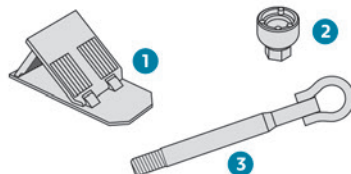

1. Chock to immobilise the vehicle (depending on equipment)
2. Socket for the security bolts (located in the glove box) (depending on equipment)
To adapt the wheelbrace to the special 'security' bolts.
3. Removable towing eye

For more information on **Towing the vehicle** and using the removable towing eye, refer to the corresponding section.

With temporary puncture repair kit

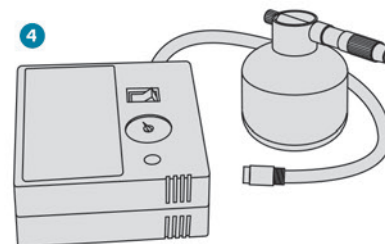

4. 12 V compressor with cartridge of sealant and speed limit sticker
For temporary repair of a tyre and to adjust the tyre pressure.

For more information on the **Temporary puncture repair kit**, refer to the corresponding section.

With spare wheel

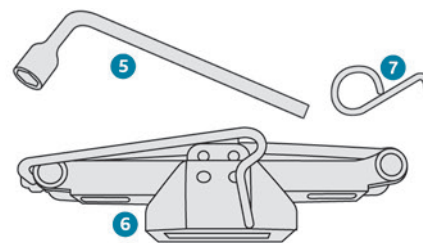

5. Wheelbrace
For removing the wheel bolts.

6. Jack with integrated handle
To raise the vehicle.
7. Wheel bolt cap removal tool
For removing the central bolt cover from alloy wheels.

For more information on the **Spare wheel**, refer to the corresponding section.

! The jack must only be used to change a wheel with a damaged or punctured tyre.

Do not use any jack other than the one supplied with the vehicle.

If the vehicle does not have its original jack, contact a PEUGEOT dealer or a qualified workshop to obtain the one that was intended by the manufacturer.

The jack meets European standards, as defined in the Machinery Directive 2006/42/CE, and also complies with UKCA requirement, as defined by the Supply of Machinery (Safety) Regulations 2008 No.1597.

The jack does not require any maintenance.

Temporary puncture repair kit

i Visit this link to view explanatory videos:
<http://q-r.to/bagGI9>



Made up of a compressor and a sealant cartridge, it allows you to carry out a **temporary repair** of the tyre so that you can drive to the nearest garage.

It is designed to repair most punctures located on the tyre tread.

i The vehicle's electric system allows the connection of the compressor to the 12 V power supply for long enough to repair a tyre after a puncture.

i For more information on the **Tool kit**, refer to the corresponding section.

i Tyre inflation pressures are indicated on this label.

For more information on **Identification markings**, particularly this label, refer to the corresponding section.



! Should the pressure of one or more tyres be adjusted, it is necessary to reinitialise the under-inflation detection system.

For more information on **Tyre under-inflation detection**, refer to the corresponding section.

Repair procedure

! Do not remove any foreign body (e.g. nail, screw) which has penetrated the tyre.

- ▶ Park the vehicle without obstructing traffic and apply the parking brake.
- ▶ Follow the safety instructions (hazard warning lamps, warning triangle, high visibility jacket, etc.) according to the legislation in force in the country in which you are driving.
- ▶ Switch the ignition off.
- ▶ Remove the valve cap from the tyre to be repaired, and place it in a clean place.

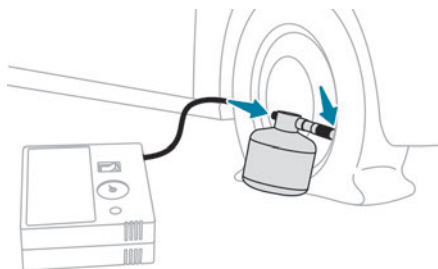

- ▶ Connect the pipe from the bottle of sealant to the valve of the tyre to be repaired and tighten firmly.
- ▶ Uncoil the pipe stowed under the compressor.
- ▶ Connect the pipe from the compressor to the bottle of sealant.
- ▶ Check that the compressor switch is in position "O".
- ▶ Fully uncoil the electric cable stowed under the compressor.
- ▶ Connect the compressor's electric plug to the vehicle's 12 V socket.



- ▶ Affix the speed limit sticker.

! The speed limit sticker must be affixed inside the vehicle in the area close to the driver, to remind them that a wheel is in temporary use.

- ▶ Switch the ignition on.

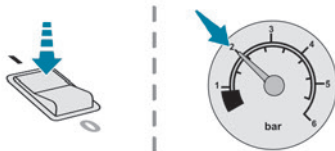

- ▶ Switch on the compressor by moving the switch to position "I" until the tyre pressure reaches 2 bar. The sealant product is injected under pressure into the tyre; do not disconnect the pipe from the valve during this operation (risk of blowback).

! If after approximately 7 minutes, the pressure of 2 bar is not reached, this indicates that the tyre is not repairable; contact a PEUGEOT dealer or a qualified workshop for assistance.

- ▶ Move the switch to position "O".
- ▶ Disconnect the compressor's electric plug from the vehicle's 12 V socket.
- ▶ Remove the kit.
- ▶ Refit the cap on the valve.
- ▶ Remove and store the bottle of sealant.

! The sealant product is harmful if swallowed and causes irritation to the eyes. Keep this product out of the reach of children. The use-by date of the fluid is marked on the bottle.

After use, do not discard the bottle into the environment; take it to a PEUGEOT dealer or an authorised waste disposal site. Do not forget to obtain a new bottle of sealant, available from a PEUGEOT dealer or a qualified workshop.

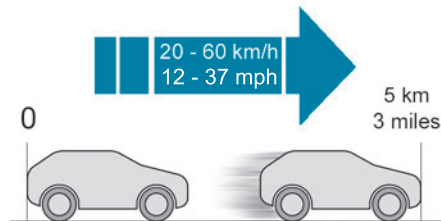

- ▶ Drive immediately for approximately 3 miles (5 kilometres) at reduced speed (between 12 and 37 mph (20 and 60 km/h)) to plug the puncture.

▶ Stop to check the repair **and the tyre pressure** using the kit:

- If the tyre pressure is incorrect, contact a PEUGEOT dealer to have the tyre changed.
- If the tyre pressure is correct, drive a second time for approximately 3 miles (5 kilometres) at reduced speed (between 12 and 37 mph (20 and 60 km/h)), stop then check again the tyre pressure using the kit to confirm the effective repair of the tyre.

! With a tyre repaired using this type of kit, do not exceed a speed of 50 mph

(80 km/h) and do not drive more than 125 miles (200 km).

You must contact a PEUGEOT dealer or a qualified workshop to have the repair checked and the tyre changed.

Checking/adjusting tyre pressures

The compressor can be used, **without injecting sealant**, to check and, if necessary, adjust the tyre pressures.

- ▶ Remove the valve cap from the tyre and keep it in a clean place.
- ▶ Uncoil the pipe stowed under the compressor.
- ▶ Screw the pipe onto the valve and tighten firmly.
- ▶ Check that the compressor switch is in position "O".
- ▶ Fully uncoil the electric cable stowed under the compressor.
- ▶ Connect the compressor's electric plug to the vehicle's 12 V socket.
- ▶ Switch the ignition on.
- ▶ Start the compressor by placing the switch at position "I" and adjust the pressure to the value shown on the vehicle's tyre pressure label. To deflate: press the black button located on the compressor pipe, near the valve connection.

! If after 7 minutes the pressure of 2 bar is not reached, the tyre is damaged;

contact a PEUGEOT dealer or a qualified workshop for assistance.

- ▶ Once the correct pressure is reached, put the switch in position "O".
- ▶ Remove the kit and stow it.
- ▶ Refit the cap on the valve.

Spare wheel

i Visit this link to view explanatory videos:
<http://q-r.to/bagGI9>



i For more information on the **Tool kit**, refer to the corresponding section.

i Spare wheel tyre pressure

The inflation pressure for the spare wheel is indicated on the tyre pressure label - ensure that its inflation pressure is checked regularly.

For more information on **Identification markings**, particularly the tyre pressure label, refer to the corresponding section.

Accessing the spare wheel

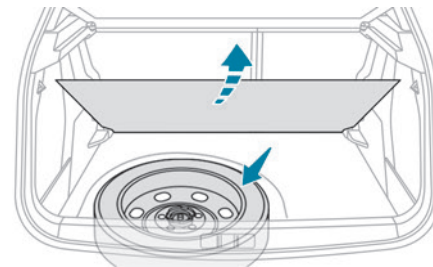

The spare wheel is stored under the boot carpet. To access the spare wheel, first refer to the **Tool kit** section.

i Depending on version, the spare wheel may be a standard steel, non-standard or 'space-saver' wheel.

Removing the spare wheel

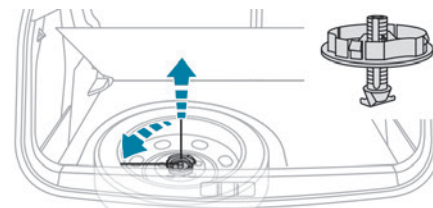

- ▶ Slacken the central nut.
- ▶ Remove the fastening device (nut and bolt).
- ▶ Lift the spare wheel towards you from the rear.

- ▶ Take the wheel out of the boot.

Putting the spare wheel back in place

! The punctured wheel cannot be put under the boot floor.

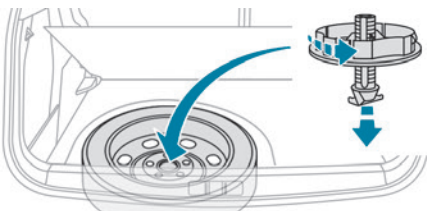

- ▶ Put the spare wheel back in place in its housing.
- ▶ Slacken the nut on the bolt by a few turns.
- ▶ Position the fastening device (nut and bolt) in the middle of the wheel.
- ▶ Tighten the central nut sufficiently to retain the wheel correctly.
- ▶ Depending on version, put the tool box back in place in the middle of the wheel and clip it in place.

Removing a wheel

! Parking the vehicle

Immobilise the vehicle where it does not obstruct traffic: the ground must be level, stable and non-slippery.

With a manual gearbox, engage first gear to lock the wheels, apply the parking brake,

unless it is set to automatic mode, and switch off the ignition.

With an automatic gearbox, select mode **P** to lock the wheels, apply the parking brake, unless it is set to automatic mode, and switch off the ignition.

Check that the parking brake indicator lamps on the instrument panel are on fixed.

The occupants must get out of the vehicle and wait where they are safe.

If necessary, place a chock under the wheel diagonally opposite the wheel to be changed. Never go underneath a vehicle raised using a jack; use an axle stand.

i Wheel with wheel trim

When removing the wheel, first remove the wheel trim by pulling at the valve aperture using the wheelbrace.

When refitting the wheel, refit the wheel trim, starting by placing its aperture in line with the valve and then pushing it into place all round its edge with the palm of your hand.

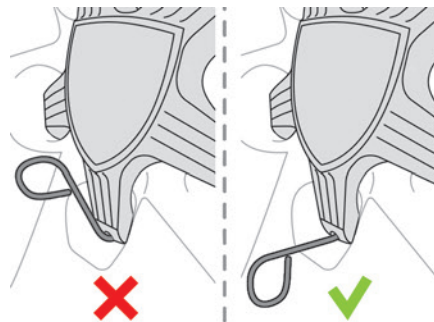
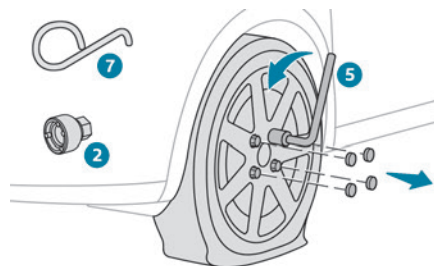

- If the vehicle has steel wheels, remove the wheel trim.
- If the vehicle has alloy wheels, remove the central bolt cover using tool 7.
- If the vehicle is so equipped, fit security bolt socket 2 to wheelbrace 5 to slacken the security bolt.
- Slacken the other bolts using the wheelbrace 5 only.

! Never use an impact wrench on the security bolt socket.

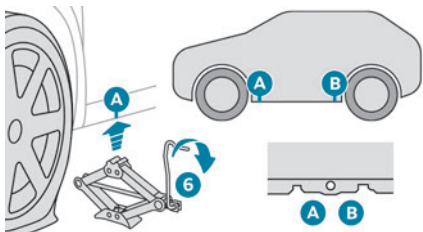

► Place the foot of jack **6** on the ground and ensure that it is directly below the front **A** or rear **B** jacking point on the underbody, whichever is closest to the wheel to be changed.

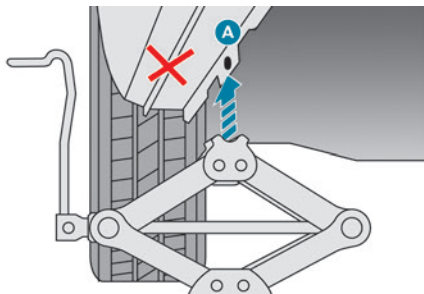

► Extend jack **6** until its head comes into contact with jacking point **A** or **B**; contact area **A** or **B** on the vehicle must be properly inserted into the central part of the head of the jack.

► Raise the vehicle until there is sufficient space between the wheel and the ground to easily admit the spare (not punctured) wheel.

! Ensure that the jack is stable. If the ground is slippery or loose, the jack may slip or collapse - risk of injury!
Take care to position the jack strictly at one of the jacking points **A** or **B** under the vehicle, ensuring that the head of the jack is centred under the contact area on the vehicle. Otherwise, there is a risk of damage to the vehicle and/or of the jack collapsing - risk of injury!

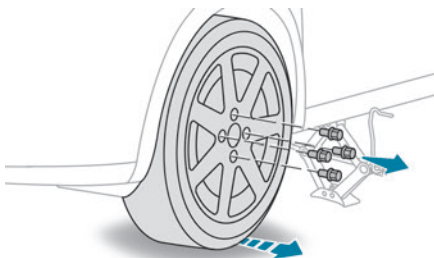

► Remove the bolts and store them in a clean place.
► Remove the wheel.

Fitting a wheel

i Fitting a steel or "space-saver" type spare wheel

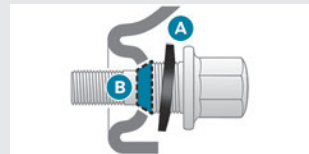

If the vehicle is fitted with alloy wheels, the washers **A** do not make contact with the steel or "space-saver" type spare wheel. The wheel is held in place by the conical contact surface **B** of each bolt.

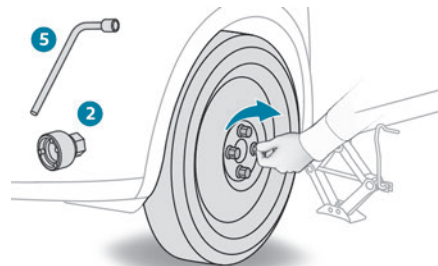

► Fit the wheel on the hub.
► Screw in the bolts by hand as far as possible.
► Pre-tighten the security bolt using the wheelbrace **5** equipped with a security socket **2**.
► Pre-tighten the other bolts using the wheelbrace **5** only.

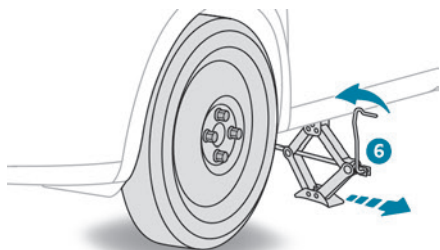

- ▶ Lower the vehicle again fully.
- ▶ Fold jack **6** and remove it.

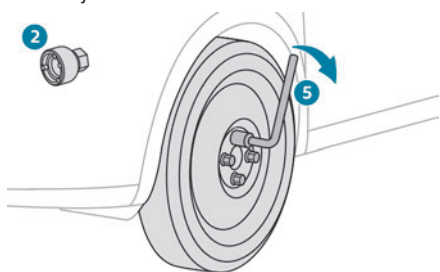

- ▶ Tighten the security bolt using the wheelbrace **5** equipped with a security socket **2**.
- ▶ Tighten the other bolts using the wheelbrace **5** only.
- ▶ Refit the bolt covers to each of the bolts (depending on equipment).
- ▶ Store the tools.

After changing a wheel

! With a non-standard or 'space-saver' spare wheel



Deactivate certain driving aid functions (Active Safety Brake, Adaptive cruise control, etc.).

Do not exceed the maximum authorised speed of 50 mph (80 km/h) or the maximum distance of 50 miles (80 km).

Driving with more than one spare wheel of this type is prohibited.

The wheel trim from the replaced wheel must not be refitted.

! Go to a PEUGEOT dealer or a qualified workshop.

Have the tightening of the spare wheel's bolts and its tyre pressure checked.

Have the punctured tyre examined. After inspection, the technician will advise you on whether the tyre can be repaired or if it must be replaced.

Changing a bulb

i In some weather conditions (e.g. low temperature or humidity), misting on the internal surface of the glass of the headlamps and rear lamps is normal, and will disappear after the lamps have been on for a few minutes.

! Never look too closely at the light beam of LED technology lamps - risk of serious eye injury!



! The headlamps have polycarbonate lenses with a protective coating:

- **Do not clean them with a dry or abrasive cloth, nor with detergent or solvent products.**
- Use a sponge and soapy water or a pH neutral product.
- When using a high-pressure washer on persistent marks, do not keep the lance directed towards the headlamps, lamps or

their edges for too long, so as not to damage their protective coating and seals.

! Changing a bulb must only be done with the ignition off and after the headlamp / lamp has been switched off for several minutes - risk of serious burns!
Do not touch the bulb directly with your fingers; use a lint-free cloth.
It is essential only to use anti-ultraviolet (UV) type bulbs, so as not to damage the headlamp.

Always replace a failed bulb with a new bulb of the same type and specification. To avoid lighting imbalance, replace the bulbs in pairs.

i **Refitting the lamp units**
Perform the operations in the reverse order to dismantling.

Light-emitting diode (LED) headlamps and lamps

Depending on version, the affected types of headlamps/lamps are:

- LED technology headlamps.
- Full LED technology headlamps.
- Front foglamps.
- Offset daytime running lamps.
- Direction indicator side repeaters.
- Side spotlamps.
- 3D rear lamps.

- Brake lamps.
- Third brake lamp.
- Number plate lamps.

! **Replacement of this type of bulb**
Contact a PEUGEOT dealer or a qualified workshop.
Do not touch LED or Full LED technology headlamps - risk of electrocution!

Front lamps

Model with Full LED technology headlamps

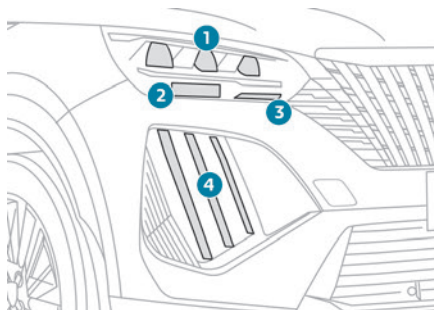

1. Dipped beam headlamps
2. Main beam headlamps
3. Direction indicators
4. Daytime running lamps / Sidelamps

Model with LED technology headlamps

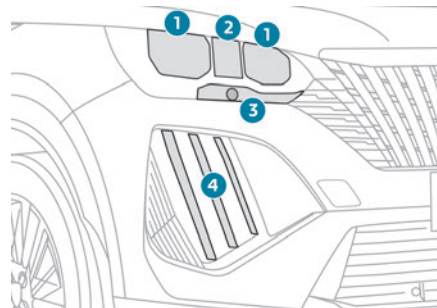

1. Dipped beam headlamps (LED)
2. Main beam headlamps (LED)
3. Direction indicators (PY21W amber).
4. Daytime running lamps / Sidelamps (LED)

! Opening the bonnet/Accessing the bulbs

Proceed with caution when the engine is hot - risk of burns!

Take care with objects or clothing that could be caught in the blades of the cooling fan - risk of strangulation!

Direction indicators

i Rapid flashing of a direction indicator lamp (left or right) indicates that one of

the bulbs on the corresponding side has failed.

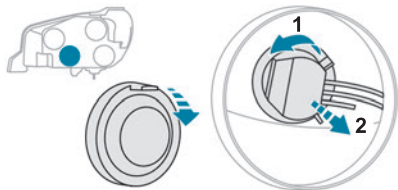

- ▶ Remove the protective cover by pulling the tab.
- ▶ Turn the bulb holder anti-clockwise.
- ▶ Pull the bulb and bulb holder assembly backwards.
- ▶ Replace the bulb.

i Amber coloured bulbs must be replaced by bulbs with identical specifications and colour.

Rear lamps

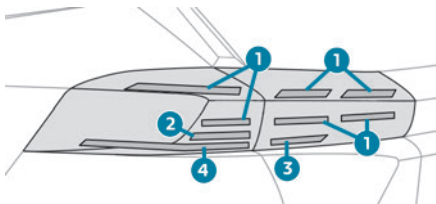

1. Sidelamps / Daytime running lamps (LED)
2. Brake lamps (LED)

3. Reversing lamps (LED)
4. Direction indicators (LED)

Foglamp (P21W)

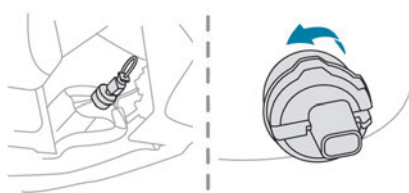

This bulb is replaced from outside the rear bumper.

- ▶ Pass your hand under the bumper.
- ▶ Disconnect the connector.
- ▶ Turn the bulb holder a quarter turn and remove it.
- ▶ Turn the bulb a quarter turn and replace it.

! When changing the bulb within a few minutes of switching off the ignition, take care not to touch the exhaust - risk of burns!

Fuses

! **Changing a fuse**
All work must be carried out only by a PEUGEOT dealer or a qualified workshop. The replacement of a fuse by a third party could cause a serious malfunction of the vehicle.

i Installing electrical accessories

The vehicle's electrical system is designed to operate with standard or optional equipment.

Before fitting other electrical equipment or accessories to your vehicle, contact a PEUGEOT dealer or a qualified workshop.

! PEUGEOT accepts no responsibility for the cost incurred in repairing the vehicle or for rectifying malfunctions resulting from the installation of accessories not supplied or not recommended by PEUGEOT and not installed in accordance with its recommendations, in particular when the combined power consumption of all of the additional equipment connected exceeds 10 milliamperes.

12 V battery / Accessory battery

Lead-acid starter batteries



These batteries contain harmful substances (sulphuric acid and lead). They must be disposed of in accordance with regulations and must never under any circumstances be discarded with household waste.

Dispose of used batteries at a designated collection point.

! Protect your eyes and face before handling the battery.

All operations on the battery must be carried out in a well ventilated area and away from naked flames and sources of sparks, to avoid any risk of explosion or fire. Wash your hands afterwards.

! **Electronic control units/LED technology headlamps**

Never connect the negative jump lead to the metal part of the electronic control units or at the back of the headlamps. Risk of destroying the electronic control units and/or headlamps! Connect to the remote earth point provided for this purpose.

! **Frozen battery**

Never try to charge a frozen battery - risk of explosion!
If the battery has frozen, have it checked by a PEUGEOT dealer or by a qualified workshop, who will verify that the internal components have not been damaged and that the case has not cracked, which could lead to a risk of leakage of toxic and corrosive acid.

! **Electronic control units/LED technology headlamps**

Never connect the negative jump lead to the metal part of the electronic control units or at the back of the headlamps. Risk of destroying the electronic control units and/or headlamps!
Connect to the remote earth point provided for this purpose.

! **Automatic gearbox**

Never try to start the engine by pushing the vehicle.

Electric vehicles

i **Flat accessory battery**

It is no longer possible to start the motor or recharge the traction battery.







! **Precautions before working on the accessory battery**

Select mode **P**, switch off the ignition, check that the instrument panel is off and that the vehicle is not being charged.

! **Jump-starting another vehicle**

Do not use the accessory battery to jump-start another vehicle or to charge another vehicle's battery.

Symbols

-  No sparks or naked flames, no smoking.
-  Always protect your eyes. Explosive gases can cause blindness and injury.
-  Keep the vehicle's battery out of the reach of children.
-  The vehicle's battery contains sulphuric acid which can make you go blind or cause severe burns.
-  For more information, refer to the handbook.
-  Explosive gases can be present close to the battery.

Procedure for starting the engine using another battery or for charging a discharged battery.

Accessing the battery

The battery is located under the bonnet.

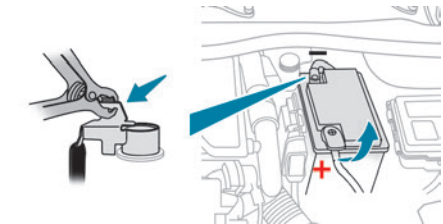

For access to the (+) terminal:

- ▶ Release the bonnet by pulling the internal release lever, then the external safety catch.
- ▶ Raise the bonnet.

(+) Positive terminal with a quick-release terminal.

(-) Negative terminal.

The negative terminal is a fastening bracket on the battery's negative terminal.

Starting using another battery

If the vehicle's battery is flat, the engine can be started using a backup battery (either external or from another vehicle) and jump leads or using a battery booster.

! Never start the engine by connecting a battery charger.

Never use a 24 V or higher battery booster. Check beforehand that the backup battery has a nominal voltage of 12 V and a capacity at least equal to that of the discharged battery.

The two vehicles must not be in contact with each other.

Switch off all electricity-consuming equipment on both vehicles (audio system, wipers, lighting, etc.).

Make sure that the jump leads are well away from the engine's moving parts (fan, belt, etc.).

Do not disconnect the (+) terminal while the engine is running.

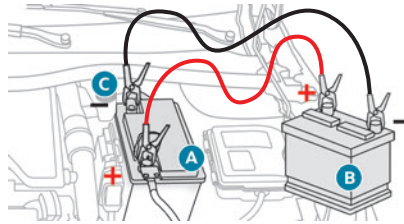

► Lift the plastic cover on the (+) terminal, if the vehicle has one.

► Connect the red cable to the (+) terminal of flat battery **A** (at the metal elbow), then to the (+) terminal of the backup battery **B** or of the booster.

► Connect one end of the green or black cable to the (-) terminal of the backup battery **B** or of the booster (or to an earth point on the assisting vehicle).

► Connect the other end of the green or black cable to the earth point **C**.

► Start the engine on the assisting vehicle and leave it running for a few minutes.

► Operate the starter on the broken down vehicle and let the engine run.

If the engine does not start immediately, switch off the ignition and wait a few moments before trying again.

► Wait for it to return to idle.

► Disconnect the jump leads **in reverse order**.

► Refit the plastic cover to the (+) terminal, if the vehicle has one.

► Allow the engine to run for at least 30 minutes, with the vehicle stationary, so that the battery reaches an adequate state of charge.

! Driving immediately without having reached a sufficient level of charge may affect some of the vehicle's functions (e.g. Stop & Start).

Charging the battery using a battery charger

For optimum service life of the battery, it is essential to maintain an adequate state of charge.

In some circumstances, it may be necessary to charge the battery:

- When using the vehicle mainly for short journeys.
- If the vehicle is to be taken off the road for several weeks.

Consult a PEUGEOT dealer or a qualified workshop.

! To charge the vehicle's battery yourself, use only a charger compatible with lead-acid batteries with a nominal voltage of 12 V.

! Follow the instructions provided by the manufacturer of the charger. Never reverse polarities.

i It is not necessary to disconnect the battery.

- ▶ Switch the ignition off.
- ▶ Switch off all electrical consumers (audio system, lighting, wipers, etc.).

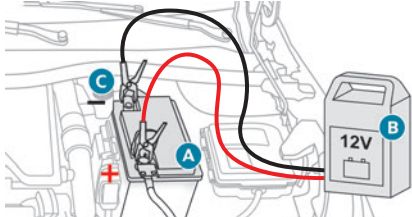

- ▶ Switch off charger **B** before connecting the cables to the battery, so as to avoid any dangerous sparks.
- ▶ Ensure that the charger cables are in good condition.
- ▶ Lift the plastic cover on the (+) terminal, if the vehicle has one.
- ▶ Connect the cables of charger **B** as follows:
 - the positive (+) red cable to the (+) terminal of battery **A**.
 - the negative (-) black cable to earth point **C** on the vehicle.
- ▶ At the end of the charging operation, switch off charger **B** before disconnecting the cables from battery **A**.

! If this label is present, use only a 12 V charger to avoid causing irreversible damage to the electrical components.

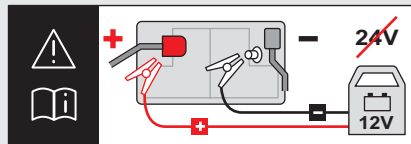

Disconnecting/reconnecting the battery

In order to maintain an adequate state of charge for starting the engine, we recommend disconnecting the battery if the vehicle is to be unused for an extended period.

Before disconnecting the battery:

- ▶ Close all openings (doors, boot, windows, roof).
 - ▶ Switch off all electricity-consuming devices (audio system, wipers, lamps, etc.).
 - ▶ Switch off the ignition and wait for 4 minutes.
- After accessing the battery, it is only necessary to disconnect the (+) terminal.

Quick-release terminal clamp

Disconnecting the (+) terminal

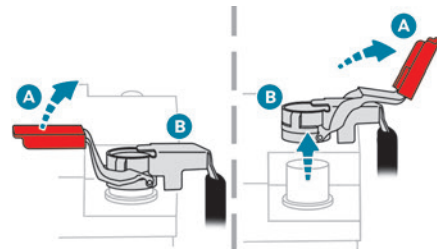

- ▶ Depending on equipment, lift the plastic cover on the (+) terminal.
- ▶ Raise lever **A** fully to release clamp **B**.
- ▶ Remove clamp **B** by lifting it off.

Reconnecting the (+) terminal

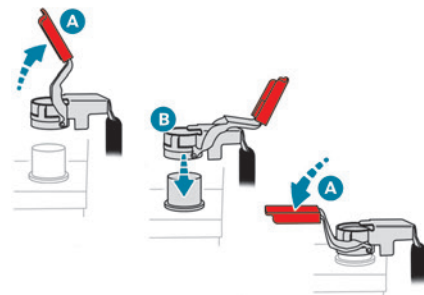

- ▶ Raise lever **A** fully.
- ▶ Refit open clamp **B** on the (+) terminal.
- ▶ Push clamp **B** fully down.

- ▶ Lower lever **A** to lock clamp **B**.
- ▶ Depending on equipment, lower the plastic cover on the **(+)** terminal.

! Do not force the lever when pressing on it, as if the clamp is not positioned correctly, locking will then not be possible. Start the procedure again.

Following reconnection

After reconnecting the battery, turn on the ignition and wait 1 minute before starting the engine, to enable the electronic systems to initialise.

If minor problems nevertheless persist following this operation, contact a PEUGEOT dealer or a qualified workshop.

Referring to the relevant section, reinitialise certain equipment:

- Remote control key or electronic key (depending on version).
- Sunroof.
- Electric windows.
- Date and time.
- Preset radio stations.

i The Stop & Start system may not be operational during the trip following the first engine start.

In this case, the system will only be available again after a continuous period with the vehicle immobilised, the duration of which depends on the exterior temperature and the state of charge of the battery (up to about 8 hours).

Towing the vehicle

i General recommendations

Observe the legislation in force in the country where you are driving.

Check that the towing vehicle is heavier than the towed vehicle.

The driver must remain at the wheel of the towed vehicle and must have a valid driving licence.

When towing a vehicle with all four wheels on the ground, always use an approved towbar; ropes and straps are prohibited.

The towing vehicle must move off gently.

When the vehicle is towed with its engine off, there is no longer braking and steering assistance.

! A professional recovery service must be called in the following cases:

- broken down on a motorway or main road;
- not possible to put the gearbox into neutral, unlock the steering, or release the parking brake;
- not possible to tow a vehicle with an automatic gearbox, with the engine running;
- towing with only two wheels on the ground;
- four-wheel drive vehicle;
- no approved towbar available.

! Before towing the vehicle, it is essential to put the vehicle in free-wheeling mode. For more information on **Free-wheeling**, refer to the corresponding section.

i Electric motor

An electric vehicle cannot under any circumstances be used to tow another vehicle.

However, it may be used, for example, to exit a rut.

Type of vehicle (engine/gearbox)	Towing constraints			
	Front wheels on the ground	Rear wheels on the ground	Flatbed	4 wheels on the ground with towbar
Internal combustion/Manual	✔	✔	✔	✔
Internal combustion/Automatic	✘	✔	✔	✘
Electric 2WD	✘	✔	✔	✘

i In case of battery or electric parking brake failure, it is essential to call a professional using flatbed recovery vehicles (excluding manual gearbox).

Accessing the tools

For more information on accessing the **Tool kit**, refer to the corresponding section.

Towing your vehicle

To access the front screw thread:

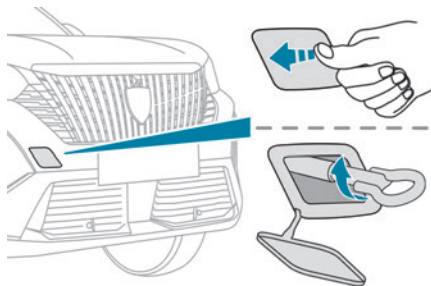

- ▶ Unclip the cover by pressing on its left-hand section.
 - ▶ Release the cover to the right and then downwards.
- To be towed:

- ▶ Screw the towing eye in fully.
- ▶ Install the towbar.
- ▶ Put the gearbox into neutral.

! Failure to observe this instruction could result in damage to certain components (e.g. braking, transmission) and to the absence of braking assistance the next time the engine is started.

! **Automatic gearbox**
Never tow the vehicle with the driving wheels on the ground and the engine off.

- ▶ Unlock the steering and release the parking brake.

- ▶ Switch on the hazard warning lamps on both vehicles in accordance with the legislation in force in the country in which you are driving.
- ▶ Move off gently, drive slowly and only for a short distance.

Towing another vehicle

To access the rear screw thread:

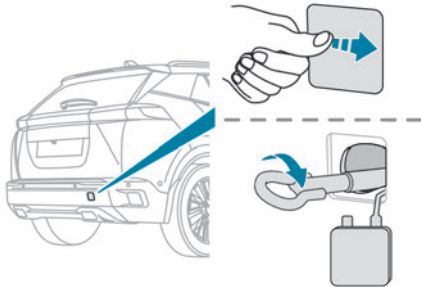

- ▶ Unclip the cover by pressing at its right-hand section.
- ▶ Pull the cover downwards.

To tow:

- ▶ Screw the towing eye in fully.
- ▶ Install the towbar.
- ▶ Switch on the hazard warning lamps on both vehicles.
- ▶ Move off gently, drive slowly and only for a short distance.

Engine technical data and towed loads

Engines

The engine characteristics are given in the vehicle's registration document, as well as in sales brochures.

Only the values available at the time of publication are presented in the tables. Contact a PEUGEOT dealer or a qualified workshop to obtain missing values.

i The maximum power corresponds to the value type-approved on a test bed, under conditions defined by European legislation (Directive 1999/99/EC).

For more information, contact a PEUGEOT dealer or a qualified workshop.

Weights and towed loads

The weights and towed loads relating to the vehicle are indicated on the registration document, as well as in sales brochures.

These values are also indicated on the manufacturer's plate or label.

For more information, contact a PEUGEOT dealer or a qualified workshop.

The GTW (Gross Train Weight) and towed load values indicated are valid up to a maximum altitude of 1,000 metres. The towed load value

must be reduced by 10% for each additional 1,000 metres of altitude.

The maximum authorised nose weight corresponds to the weight permitted on the towball.

! When exterior temperatures are high, the vehicle performance may be limited in order to protect the engine. When the exterior temperature is higher than 37°C, reduce the towed weight.

! Towing even with a lightly loaded vehicle can adversely affect its road holding. Braking distances are increased when towing a trailer. When using a vehicle to tow, never exceed a speed of 62 mph (100 km/h) (observe the local legislation in force).

Engines and towed loads - Petrol

Engines	1.2 PureTech 100 S&S	1.2 PureTech 130	1.2 PureTech 130 S&S	
Gearboxes	BVM6 (Manual 6-speed)	EAT6 (Auto. 6-speed)	BVM6 (Manual 6-speed)	EAT8 (Auto. 8-speed)
Codes	EB2ADTD MB6 STT EB2ADTD_I MB6 STT	EB2ADTSM AT6III	EB2ADTS MB6 STT EB2ADTS_I MB6 STT	EB2ADTS ATN8 STT EB2ADTS_I ATN8 STT
Model codes: UR...	HNK	HNL	HNS	HNS
Cubic capacity (cc)	1,199	1,199	1,199	1,199
Max. power: EC standard (kW)	75	96	96	96
Fuel	Unleaded (RON 95 minimum)	Unleaded (RON 91 minimum)	Unleaded (RON 95 minimum)	Unleaded (RON 95 minimum)
Braked trailer (within the GTW limit) (kg) on a 10% or 12% gradient	1,200	500	1,200	1,200
Unbraked trailer (kg)	630	500	633	640
Maximum authorised nose weight (kg)	61	61	61	61

Engines and towed loads - Diesel

Engines	1.5 BlueHDi 130 S&S
Gearboxes	EAT8 (Auto. 8-speed)
Codes	DV5RC ATN8 STT
Model codes:	YHZ
Cubic capacity (cc)	1,499
Max. power: EC standard (kW)	96
Fuel	Diesel (EN 590)
Braked trailer (within the GTW limit) (kg) on a 10% or 12% gradient	1,200
Unbraked trailer (kg)	670
Maximum authorised nose weight (kg)	61

Engines and towed loads - Electric

Model codes:	ZKWZ
Braked trailer (within the GTW limit) (kg) on a 10% or 12% gradient	0
Unbraked trailer (kg)	0
Maximum authorised nose weight (kg)	0
Electric motor	
Technology	Synchronous with permanent magnets
Max. power : EC standard (kW)/(hp)	115/156
Traction battery	
Technology	Lithium-Ion
Installed capacity (kWh)	54
Domestic charging	Mode 2
Alternating current (AC) voltage Rating (A)	230 (single-phase) 8 or 16
Accelerated charging	Mode 3
Alternating current (AC) voltage Rating (A)	230 (single-phase or three-phase) 16 or 32
Superfast charging	Mode 4
Direct current (DC) voltage	400

Dimensions (mm)

These dimensions have been measured on an unladen vehicle.

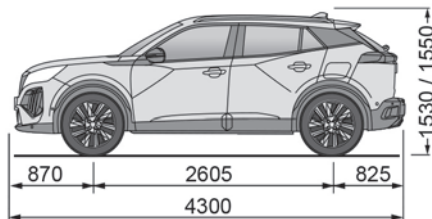
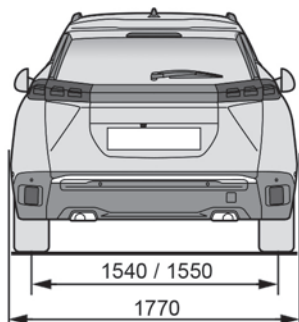
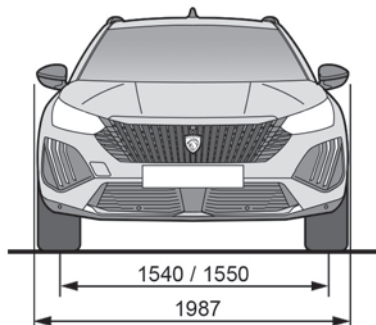

Identification markings

Various visible markings for vehicle identification and vehicle search.

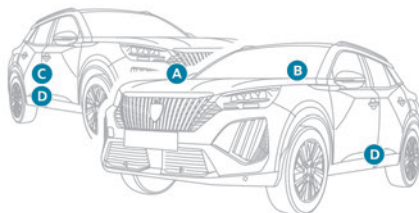

A. Vehicle Identification Number (VIN), under the bonnet.

Stamped on the chassis.

B. Vehicle Identification Number (VIN), on the dashboard.

Printed on an adhesive label visible through the windscreen.

C. Manufacturer's label.

Affixed to the right-hand door.

Bears the following information:

- Manufacturer's name.

– European whole vehicle type approval number.

– Vehicle Identification number (VIN).

– Gross vehicle weight (GVW).

– Gross train weight (GTW).

– Maximum weight on the front axle.

– Maximum weight on the rear axle.

D. Tyres/paint code label.

Affixed to the driver's door.

Bears the following information about the tyres:

– Tyre pressures, unladen and laden.

– Tyre specification, made up of the dimensions and type as well as the load and speed indices.

– Spare tyre inflation pressure.

– Also indicates the paint colour code.

i The vehicle may be originally equipped with tyres with higher load and speed indices than those indicated on the label, without affecting tyre pressure (on cold tyres). In the event of a change in the type of tyres, contact a PEUGEOT dealer for the tyre fits approved for the vehicle.

Touch screen 10" & Bluetooth Radio & Telephone

Multimedia audio system - Applications - Bluetooth® telephone

i The functions and settings described vary according to the vehicle version and configuration, as well as the country of sale.

! For safety reasons and because they require sustained attention by the driver, the following operations must be carried out with the **vehicle stationary** and the ignition on:

- Connecting the smartphone via Bluetooth, USB or Wi-Fi.
- Using the smartphone.
- Connecting to the CarPlay® or Android Auto applications (certain applications stop displaying when the vehicle is moving).
- Changing the system settings and configuration.

! Any intervention or modification on the vehicle's system is strictly forbidden
- Risk of serious burns or electric shock

(short-circuit) that could lead to death (electrocution)!
In the event of a problem, always contact a PEUGEOT dealer or a qualified workshop.

i The system is protected so that it only operates in the vehicle.
The message **Energy economy mode** is displayed when the system is about to go into standby.

i The system's Open Source Software (OSS) source codes are available at the following addresses:
<https://www.groupe-psa.com/fr/oss/>
<https://www.groupe-psa.com/en/oss/>

i The system transmits and/or receives radio waves subject to the Directive 2014/53/EU.
The manufacturers of the mentioned system declare the conformity with the Directive 2014/53/EU.
The full text of the EU declaration of conformity for each system is available at the following address:
<http://public.servicebox.peugeot.com/APddb/>

First steps



With the engine running, a press mutes the sound.

With the ignition off, a press turns the system on. Increase or decrease the volume using the wheel or the "plus" or "minus" buttons (depending on the equipment).

Use the buttons on either side of or below the touch screen to access the menus, then press the virtual buttons on the touch screen. Depending on the model, use the "**HOME**" and "**Vehicle**" buttons below the touch screen to access the menus, then press the virtual buttons on the touch screen.

At all times it is possible to display the rolling menus by pressing the screen briefly with three fingers.

On pages with multiple tabs at the bottom of the screen, you can switch between pages either by tapping the tab for the desired page or by swiping the pages to the left or right with your finger.

Press the back arrow to go back a level or confirm.

! The touch screen is of the "capacitive" type.

To clean the screen, use a soft, non-abrasive cloth (e.g. spectacles cloth) with no additional product.

Do not use sharp objects on the screen.
Do not touch the screen with wet hands.

Certain information is displayed permanently on the main screen:

- Air conditioning status information (depending on version), and direct access to the corresponding menu.
- Radio Media and Telephone menu status information.
- Privacy status information.
- Access to the touch screen and digital instrument panel settings.

Audio source selection (depending on equipment):

- FM/DAB/AM radio stations (depending on equipment).
- Telephone connected via Bluetooth and Bluetooth multimedia broadcast (streaming).
- USB Memory stick.

i In very hot conditions, the volume may be limited to protect the system. It may enter standby mode (with the screen and sound off) for 5 minutes or more.

The system will resume normal operation when the temperature in the passenger compartment has dropped.

The system is operational in temperatures between -40°C and +70°C.

Steering mounted controls



Voice control: smartphone voice commands.

Vol+

Increase volume.



Decrease volume.

Mute by pressing the volume increase and decrease buttons simultaneously (depending on equipment).

Restore the sound by pressing one of the two volume buttons.



Telephone (short press): start telephone call.

Call in progress (short press): access telephone menu.

Telephone (long press): reject an incoming call, end call; when no call is in progress, access telephone menu.



Radio (rotate): automatic search for the previous/next station.

Media (rotate): previous/next track, move through a list.

Short press: confirm a selection; if nothing selected, access presets.

Accelerated navigation.

Menus

Radio Media

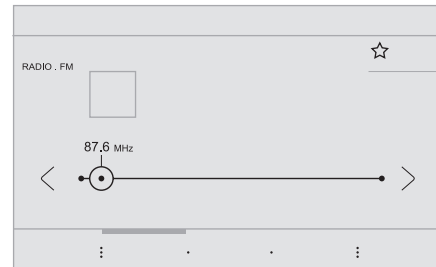

Select an audio source or radio station.

Telephone

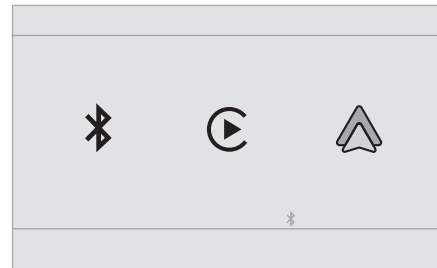

Connect a mobile phone via Bluetooth®. Run certain applications from a smartphone connected via CarPlay® or Android Auto.

Applications

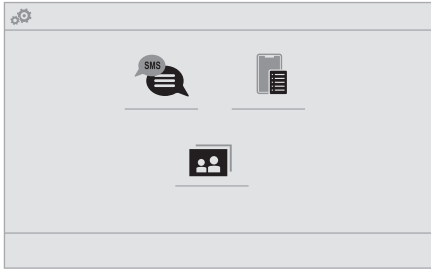

Access configurable equipment.

Driving



Activate, deactivate or configure certain vehicle functions.

Settings

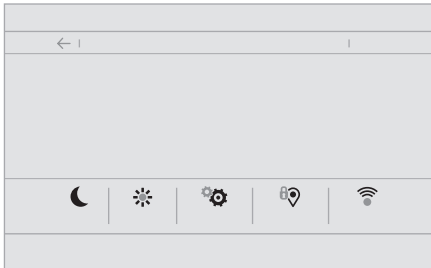

Configure the sound (balance, ambience, etc.), the display (language, units, date, time, etc.), and some system functions.

Navigation

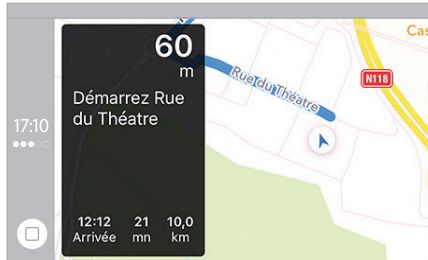

Configure the navigation and select your destination via CarPlay® or Android Auto.

Air conditioning

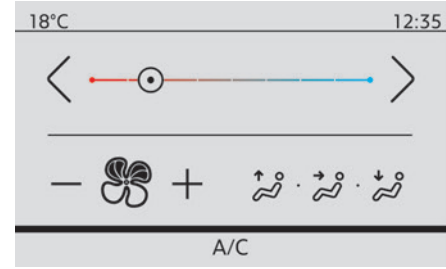

Manage various temperature and air flow settings.

Radio

Selecting a station



Press **Radio Media** to display the main page.



Press one of the buttons to perform an automatic search for radio stations.

Or



Move the slider to manually search for frequencies up or down.

Or



Press the frequency to enter the FM and AM waveband values using the virtual keypad.

OK

Press **"OK"** to confirm.

! Radio reception may be affected by the use of electrical equipment not approved by the Brand, such as a USB charger connected to the 12 V socket. The exterior environment (hills, buildings, tunnels, basement car parks, etc.) may block reception, including in RDS mode. This phenomenon is perfectly normal in the context of radio wave transmission, and in no way indicative of an audio system malfunction.

Changing the waveband



Press **Radio Media** to display the main page.

Press the **"OPTIONS"** button to access the secondary page.



Press **"Band"** to change waveband.



Press in the shaded area to confirm.

Presetting a station

Select a radio station or frequency.



Make a short press on the star outline. If the star is solid, the radio station is already preset.

Or

Select a radio station or frequency.

Press **"Preset"**.



Make a long press on one of the buttons to preset the station.

Activating/Deactivating RDS

RDS, if activated, allows you to continue listening to the same station by automatically retuning to alternative frequencies.



Press **Radio Media** to display the main page.

Press the **"OPTIONS"** button to access the secondary page.



Activate/deactivate **"RDS"**.



Press in the shaded area to confirm.



RDS station tracking may not be available nationwide, as many radio stations do not cover 100 % of the country. This explains the loss of reception of the station during a journey.

Displaying text information

The "Radio Text" function displays information transmitted by the radio station relating to the station or the currently playing song.



Press **Radio Media** to display the main page.

Press the **"OPTIONS"** button to access the secondary page.



Activate/deactivate **"News"**.



Press in the shaded area to confirm.

Playing TA messages

The TA (Traffic Announcement) function gives priority to TA alert messages. To operate, this function needs good reception of a radio station that transmits this type of message. While traffic information is being broadcast, the current media is automatically interrupted so that the TA message can be heard. Normal play of the previously playing media resumes at the end of the message.



Press **Radio Media** to display the main page.

Press the **"OPTIONS"** button to access the secondary page.



Activate/deactivate **"TA"**.



Press in the shaded area to confirm.

Audio settings



Press **Radio Media** to display the main page.

Press the **"OPTIONS"** button to access the secondary page.



Press **"Audio settings"**.



Select the **"Tone"**, **"Balance"** or **"Sound"** tab to configure the sound settings.



Press the back arrow to confirm.



In the **"Tone"** tab, the **Ambience**, **Bass**, **Medium** and **Treble** sound settings are

different and independent for each audio source.

In the **"Balance"** tab, the **All passengers, Driver and Front only** settings are common to all sources.

In the **"Sound"** tab, activate or deactivate **"Volume linked to speed"**, **"Auxiliary input"** and **"Touch tones"**.

! The balance/distribution (or spatialisation with the Arkamys® system) uses audio processing to adjust the sound quality according to the number of passengers in the vehicle.

i Onboard audio: Arkamys Sound Staging® optimises the sound distribution inside the passenger compartment.

DAB (Digital Audio Broadcasting) radio

Terrestrial Digital Radio

Digital radio provides higher quality sound. The various "multiplexes/ensembles" offer a choice of radio stations organised in alphabetical order.

 Press **Radio Media** to display the main page.

Press the **"OPTIONS"** button to access the secondary page.



Press **"Band"** to select **"DAB band"**.



Press in the shaded area to confirm.

FM-DAB Follow-up

"DAB" does not cover 100% of the territory. When the digital radio signal is poor, the "FM-DAB Follow-up" enables you to continue listening to the same station by automatically switching to the corresponding "FM" analogue station (if there is one).



Press **Radio Media** to display the main page.

Press the **"OPTIONS"** button to go to the secondary page.



Activate/deactivate **"FM-DAB Follow-up"**.



Press in the shaded area to confirm.

i If "FM-DAB Follow-up" is activated, there may be a time offset of a few seconds when the system switches to "FM" analogue radio, and in some cases a change in volume. When the digital signal quality is restored, the system automatically changes back to "DAB". To minimise this time lag, storing radio stations in the "DAB" band is recommended.

! If the "DAB" station being listened to is not available on "FM", or if "FM-DAB Follow-up" is not activated, the sound will cut out when the digital signal becomes too weak.

Media

USB port



Insert the USB memory stick into the USB port or connect the USB device to the USB port using a suitable cable (not supplied).



To protect the system, do not use a USB hub.

The system builds playlists (in temporary memory); this operation can take from a few seconds to several minutes at the first connection.

Reduce the number of non-music files and the number of folders to reduce the waiting time. Playlists are updated whenever the ignition is switched off or a USB memory stick is connected. The audio system memorises these lists, which will subsequently load faster if they have not been changed.

Selecting the source



Press **Radio Media** to display the main page.

Press the **"SOURCES"** button.
Select the source.

BluetoothStreaming®

Streaming allows you to listen to the audio feed from your smartphone.

The Bluetooth profile must be activated.

First adjust the volume on the portable device (to a high level). Then adjust the volume of the system.

If play does not start automatically, it may be necessary to start the audio playback from the smartphone.

Control is from the portable device or by using the system's touch buttons.

i Once connected in Streaming mode, the smartphone is considered to be a media source.

Connecting Apple® players

Connect the Apple® player to the USB socket using a suitable cable (not supplied).

Play starts automatically.

Control is via the audio system.

i The classifications available are those of the portable device connected (artists/albums/genres/playlists/audio books/podcasts). It is also possible to use a classification structured in the form of a library.

The default classification used is by artist. To modify the classification used, return to the first level of the menu then select the desired classification (playlists for example) and

confirm to go down through the menu to the desired track.

The version of software in the audio system may not be compatible with the generation of the Apple® player.

Information and advice

The system supports USB mass storage devices, BlackBerry® devices or Apple® players via the USB ports. The adapter cable is not supplied.

Devices are managed using the audio system controls.

Other devices, not recognised on connection, must be connected via Bluetooth streaming, if compatible.

! To protect the system, do not use a USB hub.

The audio system will only play audio files with ".wav", ".wma", ".aac", ".ogg" and ".mp3" file extensions, at bit rates between 32 Kbps and 320 Kbps.

It also supports VBR (Variable Bit Rate) mode. No other file types (".mp4", etc.) can be read.

All ".wma" files must be standard WMA 9 files. The supported sampling rates are 11, 22, 44 and 48 KHz.

To avoid reading and display problems, we recommend choosing file names less than 20 characters long that do not contain any special characters (e.g. " ? . ; ù).

Use only USB memory sticks in FAT32 format (File Allocation Table).

i We recommend using the original USB cable for the portable device.

Telephone

Pairing a Bluetooth® telephone

! The services available depend on the network, the SIM card and the compatibility of the Bluetooth devices used. Consult the telephone user guide and the service provider to check which services are available.

The Bluetooth function must be activated and the telephone configured as "Visible to all" (in the telephone settings).

To complete the pairing, whichever procedure is used (from the telephone or from the system), ensure that the code is the same in the system and in the telephone.

i If the pairing procedure fails, we recommend deactivating and then reactivating the Bluetooth function on the telephone.

Procedure from the telephone



Select the name of the system in the list of detected devices.

In the system, accept the connection request from the telephone.

Procedure from the system



Press **Telephone** to display the main page.



Press **"Connected Devices"**.

The list of detected telephones is displayed.



Press this button to start searching for new devices.



Select the name of the chosen telephone in the list.

Complete the pairing with the displayed code.

Connection sharing

The system offers to connect the telephone with 3 profiles:

- **"Telephone"** (hands-free kit, telephone only),
- **"Streaming"** (streaming: wireless playing of audio files on the telephone),
- **"Mobile internet data"**.



Select one or more profiles.



Press **"OK"** to confirm.

Depending on the type of telephone, you may be prompted to accept the transfer of contacts and messages.



The ability of the system to connect just one profile depends on the telephone. All three profiles may connect by default.



The profiles compatible with the system are: HFP, OPP, PBAP, A2DP, AVRCP, MAP and PAN.

Visit the Brand's website for more information (compatibility, additional help, etc.).

Automatic reconnection

On returning to the vehicle, if the last telephone connected is present again, it is automatically recognised and within about 30 seconds after switching on the ignition, the pairing is established automatically (Bluetooth activated).

To modify the connection profile:



Press **Telephone** to display the main page.

Press the **"PHONE"** button to access the secondary page.



Press **"Bluetooth connection" to display the list of paired devices.**



Press the **"Details"** button for a paired device.



Select one or more profiles.



Press **"OK"** to confirm.

Managing paired telephones

This function lets you connect or disconnect a device or delete a pairing.



Press **Telephone** to display the main page.

Press the **"PHONE"** button to access the secondary page.



Press **"Bluetooth connection" to display the list of paired devices.**



Press on the name of the telephone selected in the list to disconnect it.

Press again to connect it.

Deleting a telephone



Press the basket at the top right of the screen to display a basket alongside the telephone chosen.



Press the basket alongside the telephone chosen to delete it.

Receiving a call

An incoming call is announced by a ring and a superimposed display in the screen.



Make a short press on the steering mounted **PHONE** button to accept an incoming call.

And



Make a long press



on the steering mounted **PHONE** button to reject the call.

Or



Making a call

! Using the telephone is not recommended while driving.
Parking the vehicle.
Make the call using the steering mounted controls.

Calling a new number

- Press **Telephone** to display the main page.
- Enter the phone number using the digital keypad.
- Press "**Call**" to start the call.

Calling a contact

- Press **Telephone** to display the main page.
- Or press and hold
- the steering mounted **PHONE** button.

Press "**Contacts**".
Select the desired contact from the displayed list.

- Press "**Call**".

Calling a recently used number

- Press **Telephone** to display the main page.
- Or
- Press and hold
- the steering mounted button.

Press "**Recent calls**".
Select the desired contact from the displayed list.

i It is always possible to make a call directly from the telephone; as a safety measure, first park the vehicle.

Setting the ringtone

- Press **Telephone** to display the main page.
- Press the "**OPTIONS**" button to access the secondary page.
- Press "**Ring volume**" to display the volume bar.
- Press the arrows or move the slider to set the ring volume.

Using CarPlay® or Android Auto

Synchronising a smartphone enables users to display applications that support the smartphone's CarPlay® or Android Auto

technology on the vehicle's screen. For CarPlay® technology, the CarPlay® function must first be activated on the smartphone.
The smartphone can be connected via USB cable or via a wireless connection.

i Unlock the smartphone for the communication process between the smartphone and the system to work. As principles and standards are constantly changing, **we recommend keeping the smartphone's operating system up-to-date, together with the date and time on the smartphone and the system.**

i For the list of compatible smartphones, visit the Manufacturer's website in your country.

USB sockets

Depending on equipment, for more information on the USB sockets compatible with **CarPlay®** or **Android Auto** applications, refer to the "Ease of use and comfort" section.

Wireless connection

! Before using CarPlay® or Android Auto wirelessly, ensure the Wi-Fi regulatory restrictions of your geographic location are

met, as indicated by a message on the touch screen.

If the 5 GHz Wi-Fi network frequency is not allowed in your location, select **2.4 GHz** at the first connection.

Check the Wi-Fi restrictions again when you travel to different locations and set the Wi-Fi frequency accordingly.

The regulations of the 5 GHz frequency are specific to each country. Refer to the regulation in force in your country.

i When using CarPlay® with 5 GHz frequency activated, there may be interference with certain devices (tolls, parking...) resulting in a disconnection. To prevent this from happening, it is recommended to disable the 5 GHz function.

i Difficulties in connecting wirelessly your smartphone may happen, due to:

- Interference with other Wi-Fi networks.
- Interference with certain devices (tolls, parking) when using Android Auto.
- An unsuitable configuration of the smartphone.

In these cases, it is recommended to connect the smartphone with its original cable.

CarPlay® smartphone connection

The availability of the application depends on the country.

USB connection

i On connecting the USB cable, the CarPlay® function deactivates the system's Bluetooth® mode. The **"CarPlay"** function requires the use of a compatible smartphone and compatible applications.



Connect the USB cable.

The smartphone charges when connected by the USB cable.



From the system, press **"Telephone"** to display the main page.



Press **"CarPlay"** to display the CarPlay® interface.

i CarPlay® interface may appear automatically.

i When the USB cable is disconnected and the ignition is switched off then back on, the system will not automatically switch to Radio Media mode; the source must be changed manually.



The CarPlay® navigation can be accessed at any time by pressing the system's

Navigation button.

Wireless connection

First activate the smartphone's Bluetooth® function.



From the system, press **"Telephone"** to display the main page.

If the device has already been connected to the system via Bluetooth®, select the device settings from the list of known devices and choose CarPlay® as the wireless connection mode. If the device has never been connected to the system before, it will have to be paired (refer to the corresponding section).

The system detects if the smartphone is compatible with CarPlay® and offers to connect to it following the pairing process. Subsequent automatic connection of the smartphone requires activation of the Bluetooth® on your device.



As soon as the connection is established, press **"CarPlay"** to display the CarPlay® interface.





Press and hold this steering-mounted control button and say "Siri" to initiate the smartphone voice commands.

Android Auto smartphone connection

The availability of the application depends on the country.

 On the smartphone, download the Android Auto application.

 The "Android Auto" function requires the use of a compatible smartphone and applications.

 The first connection of Android Auto to the system should be made by USB cable.

USB connection

 Connect a USB cable.

The smartphone charges when connected by a USB cable.

 From the system, press "**Telephone**" to display the main page.

 Press "**Android Auto**" to start the application in the system.

Depending on the smartphone, it may be necessary to activate the "**Android Auto**" function.

OK During the procedure, several screen pages relating to certain features are displayed.

Accept to start and complete the connection.

 When connecting a smartphone to the system, we recommend enabling Bluetooth® on the smartphone.

Wireless connection

First activate the smartphone's Bluetooth® function.

 Connect a USB cable.

 From the system, press "**Telephone**" to display the main page.

If the device has already been connected to the system via Bluetooth®, select the device settings from the list of known devices and choose Android Auto® as the wireless connection mode. If the device has never been connected to the system before, it will have to be paired (refer to the corresponding section).

The system detects if the smartphone is compatible with Android Auto and offers to connect to it following the pairing process. Subsequent automatic connection of the smartphone requires activation of the Bluetooth® on your device.

 As soon as the connection is established, press "**Android Auto**" to display the Android Auto interface.

 Press and hold this steering-mounted control button and say "OK Google" to initiate the smartphone voice commands.

Access to the different audio sources remains available in the margin of the Android Auto display, using the touch buttons located in the upper bar.

Access to the menus for the system is possible at any time using the dedicated buttons.

 There may be a pause before applications become available, depending on the quality of the network.

Applications

Viewing photos

Insert a USB memory stick in the USB port.

 To protect the system, do not use a USB hub.

The system can read folders and image files in the formats: .tiff; .gif; .jpg/jpeg; .bmp and .png.

 Press **Applications** to display the main page.

 Press "**Photos**".

 Select a folder.

 Select an image to view.







 Press this button to display the details of the photo.

 Press the back arrow to go back a level.

Managing messages



 Press **Applications** to display the main page.

 Press "SMS".

-  Select the "SMS" tab.
-  Press this button to select the display settings for messages.
-  Press this button to search and select a recipient.
-  Select the "Quick messages" tab.
-  Press this button to select the display settings for messages.
-  Press this button to write a new message.
-  Press the bin alongside the selected message to delete it.
-  Press this button alongside the selected message to display the secondary page.
-  Press this button to edit and modify the existing text.
-  Press this button to write a new message.
-  Press the bin to delete the message.

Settings



Adjusting the brightness

-  Press **Settings** to display the main page.
-  Press **Brightness**.

-  Move the slider to adjust the brightness of the screen and/or the instrument panel (depending on version).

 Press in the shaded area to confirm.

Modifying system settings

-  Press **Settings** to display the main page.
-  Press "**Configuration**" to access the secondary page.
-  Press "**System configuration**".



Press the "**Units**" tab to change the units of distance, fuel consumption and temperature.
Press the "**Factory settings**" tab to restore the initial settings.

 Returning the system to factory settings activates the English language by default (depending on version).

Press the "**System info**" tab to display the versions of the various modules installed in the system.





Press the "**Privacy**" tab,

or

-  Press **Settings** to display the main page.
-  Press "**Privacy**" to activate or deactivate the private data mode.
-  Activate or deactivate:

– "**No sharing (data, vehicle position)**".

- "**Only data sharing**"
- "**Data and vehicle position sharing**"

-  Press the back arrow to confirm.
-  Press **Settings** to display the main page.
-  Press "**Configuration**" to access the secondary page.
-  Press "**Screen configuration**".

Press "**Brightness**".

 Move the slider to adjust the brightness of the screen and/or the instrument panel (depending on version).





 Press the back arrow to confirm.

Press "**Animation**".









- Activate or deactivate: "**Automatic scrolling**".
- Select "**Animated transitions**".

 Press the back arrow to confirm.

Selecting the language



-  Press **Settings** to display the main page.
-  Press "**Configuration**" to access the secondary page.
-  Select "**Language**" to change the language.
-  Press the back arrow to confirm.





Setting the time

-  Press **Settings** to display the main page.
-  Press "**Configuration**" to access the secondary page.
-  Press "**Date and time**".
- Select "**Time**".
-  Press this button to set the time using the virtual keypad.
- OK** Press "**OK**" to save the time.
-  Press this button to set the time zone.
-  Select the display format for the time (12h/24h).
-  Activate or deactivate summer time (+1 hour).
-  Press the back arrow to save the settings.

i The system may not automatically manage the change between winter and summer time (depending on the country of sale).



Setting the date

-  Press **Settings** to display the main page.
-  Press "**Configuration**" to access the secondary page.

-  Press "**Date and time**".
- Select "**Date**".
-  Press this button to set the date.
-  Press the back arrow to save the date.
-  Select the display format for the date.
-  Press the back arrow again to confirm.

i Time and date setting is only available if "GPS Synchronisation:" is deactivated.

Wifi settings

-  Press **Settings** to display the main page.
-  Press "**Wifi**" to access network frequency setting.
-  Activate or deactivate the **5 GHz Wifi** function.

i Android Auto uses the 5 GHz frequency. CarPlay® uses the 2,4 and 5 GHz frequency.

i When using CarPlay® with 5 GHz frequency activated, there may be interference with certain devices (tolls, parking...) resulting in a disconnection. To prevent this from happening, it is recommended to disable the 5 GHz function.

i Difficulties in connecting wirelessly your smartphone may happen, due to:

- Interference with other Wi-Fi networks.
- Interference with certain devices (tolls, parking) when using Android Auto.
- An unsuitable configuration of the smartphone.

In these cases, it is recommended to connect the smartphone with its original cable.

i The regulations of the 5 GHz frequency are specific to each country. Refer to the regulation in force in your country.

Frequently asked questions

The following information groups together the answers to the most frequently asked questions concerning the system.

Radio

The reception quality of the tuned radio station gradually deteriorates or the station presets are not working (no sound, 87.5 MHz is displayed, etc.).

The vehicle is too far from the selected station's transmitter, or no transmitter is present in the geographical area.

► Activate the "RDS" function in the upper bar to enable the system to check whether there is a more powerful transmitter in the geographical area.

The environment (hills, buildings, tunnels, basement car parks, etc.) is blocking reception, including in RDS mode.

This is a perfectly normal phenomenon, and is not indicative of an audio system malfunction. The aerial is missing or has been damaged (for example while entering a car wash or underground car park).

► Have the aerial checked by a dealer.

I cannot find some radio stations in the list of received stations.

The name of the radio station changes.

The station is no longer received or its name has changed in the list.

► Press the round arrow on the "List" tab on the "Radio" page.

Some radio stations send other information in place of their name (the title of the song for example).

The system interprets these details as the station name.

► Press the round arrow on the "List" tab on the "Radio" page.

Media

Playback of my USB memory stick starts only after a very long wait (around 2 to 3 minutes).

Some files supplied with the memory stick may greatly slow down access to reading the memory

stick (multiplication by 10 of the cataloguing time).

► Delete the files supplied with the memory stick and limit the number of sub-folders in the file structure on the memory stick.

Some characters in information about the currently playing media are not displayed correctly.

The audio system is unable to process certain types of character.

► Use standard characters to name tracks and folders.

Playback of streaming files does not start.

The connected device does not automatically launch playback.

► Start playback from the device.

Track names and playing times are not displayed on the audio streaming screen.

The Bluetooth profile does not allow the transfer of this information.

Telephone

I cannot connect my Bluetooth telephone.

The telephone's Bluetooth function may be switched off or the device may not be visible.

► Check that the telephone has Bluetooth switched on.

► Check in the telephone settings that it is "visible to all".

The Bluetooth telephone is not compatible with the system.

► Check the compatibility of the telephone on the Brand's website (services).

Android Auto and/or CarPlay do not work.

Android Auto and CarPlay may not activate if the USB cables are of poor quality.

► Use genuine USB cables to ensure compatibility.

Android Auto and/or CarPlay do not work.

Android Auto and CarPlay are not available in all countries.

► Check the Google Android Auto or Apple website to see which countries are supported.

The volume of the telephone connected in Bluetooth mode is inaudible.

The volume depends on both the system and the telephone.

► Increase the volume of the audio system, to maximum if required, and increase the volume of the telephone if necessary.

Ambient noise affects the quality of the telephone call.

► Reduce ambient noise (close windows, turn down ventilation, slow down, etc.).

The contacts are not listed in alphabetical order.

Some telephones offer display options.

Depending on the settings chosen, contacts can be transferred in a specific order.

► Modify the telephone directory display settings.

Settings

When the treble and bass settings are changed, the ambience is deselected.

When the ambience is changed, the treble and bass settings are reset.

Selecting an ambience imposes the treble and bass settings, and vice versa.

- ▶ Modify the treble and bass or ambience settings to obtain the desired musical ambience.

When the balance settings are changed, the distribution is deselected.

When the distribution setting is changed, the balance settings are deselected.

Selecting a distribution setting imposes the balance settings, and vice versa.

- ▶ Modify the balance setting or the distribution setting to obtain the desired sound quality.

There is a difference in sound quality between audio sources.

To allow for optimal listening quality, the sound settings can be tailored to different audio sources, which can generate audible differences when changing source.

- ▶ Check that the sound settings are appropriate to the sources listened to. Adjust the sound functions to the middle position.

When the engine is off, the system switches off after several minutes of use.

When the engine is switched off, the system's operating time depends on the state of charge of the battery.

The switch-off is normal: the system automatically goes into energy economy mode and switches off to maintain an adequate charge in the battery.

- ▶ Start the vehicle's engine to increase the charge of the battery.

PEUGEOT i-Connect Advanced - PEUGEOT i-Connect

GPS navigation - Applications - Multimedia audio system - Bluetooth® telephone

 The functions and settings described vary according to the version and configuration of the vehicle, and according to the country of sale.

 For safety reasons and because they require continued attention on the part of the driver, the following operations must be carried out with the **vehicle stationary** and the ignition on:

- Pairing the smartphone with the system via Bluetooth®.
- Using the smartphone.
- Connecting to Mirror Screen (Apple®CarPlay® or Android Auto).
- Changing the system settings and configuration.

 The message **Energy economy mode** is displayed when the system is about to go into standby.
For more information on **Energy economy mode**, refer to the "Practical information" section.

 The AM radio selection mode is not available on electric vehicles.

 **Warning**
Navigation is a driving aid. It cannot replace the driver. All guidance instructions should be carefully checked by the user. By using the navigation, you accept the following terms and conditions:
https://www.tomtom.com/en_gb/legal/eula-automotive/?388448

First steps

 The system starts when the ignition is switched on.

Short press, ignition off: system on/off.

Short press, ignition on: mute/restore sound.

Long press, ignition on: start standby mode (mute sound, screens and clock display off).

Rotation: volume adjustment.

Information

This system gives access to the following elements:

- Audio equipment and telephone controls with display of associated information.
- Connected services and display of associated information.
- Navigation system controls and display of associated information (depending on equipment).
- Voice recognition (depending on equipment).
- Time and outside temperature.
- Heating/air conditioning system controls and reminders of settings.
- Settings for driving aid functions, comfort and safety functions, extended head-up display (depending on equipment and version), audio equipment and digital instrument panel.
- Settings for functions specific to electric vehicles.
- Display of visual manoeuvring aid functions.
- Interactive handbook.
- Video tutorials (e.g. screen management, driving aids, voice recognition).

Upper banner

Certain information is displayed permanently in the upper banner of the touch screen:

- Outside temperature from the vehicle's sensors (associated with a blue symbol if there is a risk of ice).
- Temperature setting reminder for the air conditioning on the driver's and passenger sides.
- Charge level of the connected smartphone.
- System connection status (Bluetooth®, Wi-Fi, mobile telephone network).

- Time.
- Quick access to the Mirror Screen® functions (associated with a connected smartphone). Swipe down from the upper edge of the touch screen to access the notifications centre and display a list of quick settings :Guest, Privacy Settings, Brightness, My Devices, night mode, etc.

Principles



► Use this button (HOME) to display the most recent home page used; a second press displays the first home page, then press the virtual buttons displayed on the touch screen.



Scroll through the home pages by sliding your finger along the screen to the right or to the left.

Principle of movement in the system

Depending on the pages displayed on the screen, scroll through the text or the menu (on the left side of the screen) by sliding your finger, as with a smartphone.

Touch buttons



Display/hide the context menu.



Return to the previous page.

► To change the status of a function, press the description for the corresponding line (change confirmed by the slider moving to the right/left: function activated/deactivated).



Access to additional information about the function.



Access to a function's settings.



Add/delete shortcuts.

Configuring profiles



Press the "Settings" application.

In the list, select the "Profile" tab. The screen displays a "Guest" profile built into the system and allows you to create and personalise several new profiles with or without an associated mobile device.



The "Guest" profile has a default display with the possibility of adding to it and/or returning it to its initial configuration. This profile is built into the system and cannot be deleted.



Each profile created can be associated with a mobile device of your choice connected via Bluetooth®; the Bluetooth® function of the mobile device must first be activated. This association allows the system to detect your presence in the vehicle when it starts and to propose the activation of your personalised profile.

If a profile is not connected to the mobile device, the last profile used will be highlighted.



Select "Create Profile", then follow the procedure.

Creating a new profile allows you to personalise:

- Language, units, Privacy Settings.

- Screen configuration, appearance, i-Toggles (depending on equipment).
- Audio settings, favourite radio stations.
- Lighting, interior ambience (refer to the "Ease of use and comfort" section).
- Navigation history, favourite points of interest (POIs), navigation settings.
- Some driving aids and the list of favourites.



To delete a profile, select it from the list of profiles then press the bin.

Privacy Settings

The "Privacy Settings" management is associated with each profile. This function is used with:

a "Guest" profile configured by default in "Private Mode",

or

a profile to be created in the system, with or without connection to a mobile device.

For each profile (even "Guest"), the last privacy mode saved value will be restored.



"Sharing Data and Location"

This mode allows the vehicle to externally transmit all the personal data needed for each valid available connected service.



The personal data required to use the connected services is sent to the providers of these services.



"Sharing Data"

This mode allows the vehicle to externally transmit all the data needed for each valid

available connected service, with the exception of vehicle location data (e.g. GPS coordinates).

i Some connected services may not function without the vehicle location data.

i This mode will not be applied to the emergency call function or to specific services to which the user has consented under the terms of commercial contracts (e.g. Connected alarm).

 **"Private Mode"**
This mode does not allow the vehicle to transmit personal data outside the vehicle.

i Connected services will only perform local processing inside the vehicle with limited functions.

i This mode will not be applied to the emergency call function or to specific services to which the user has consented under the terms of commercial contracts (e.g. Connected alarm).

i **Professional purposes**
If the vehicle is used for professional purposes or under the terms of specific contracts (e.g. corporate fleet, government assignment), some privacy modes will not be available for the user on the screen, depending on the data sharing needs of the services.

To change mode, swipe down from the upper edge of the touch screen to display all of the quick settings.



Press this button and select the chosen mode. The mode is highlighted.

OR



Press the **"Settings"** application.

In the list, select the **"Connectivity"** tab.



Select **"Privacy Settings"**.



Choose the mode.

Internet portal

During the first use, upon acquisition of the vehicle, the user is invited to select the country of residence for the use of the Internet portal. If the country is not selected, the notification is stored in the notification centre and disappears once the country is selected. Slide a finger on the touch screen from top to bottom to display all the notifications.

The selection of a country is necessary to use the available internet applications.



Press the **"Settings"** application.

In the list, select the **"Connected Services"**.



Choose the country.



The first time you use it, via a connected mobile device, the system links to your profile. The connected mobile device serves as

an access key to saved personal information. First activate the mobile device's Bluetooth® function.

Select the desired application, authentication will be requested if necessary. This authentication will be saved for future uses via the mobile device connected to the current profile.

An authentication will be requested at each use if the mobile device is not connected to the current profile or if the Guest profile is used.



With the use of the "Guest" profile, an identification will be requested for each use.

Updating the system

i **Managing devices remotely and remote updating of software and firmware.**

Being an integral part of the service used to provide connected services contract(s), the required management of devices as well as the required updating of the software and firmware associated with the aforementioned connected service will be carried out remotely, in particular using "Over the Air" technology. To do this, a secure connection via radio network is established between the vehicle and the Manufacturer's device management server each time the ignition is switched on, when a mobile telephone network is available. Depending on the vehicle's equipment, the connection configuration must be set

to "Connected vehicle" to enable to the connection to the radio network. Irrespective of a valid subscription to a connected service, the remote management of devices relating to or connected with the security of devices, and the updating of software and firmware, will be carried out when necessary in order to comply with a legal requirement applicable to the Manufacturer (e.g. the applicable law in terms of product liability, the regulations governing e-call) or when necessary to protect the respective vital interests of the vehicle's users and passengers.

The establishment of a secure connection via radio network and the corresponding remote updates are not affected by the privacy settings and are intended to be carried out after being initialised by the user in response to a related notification.

The system can notify the receipt of an update when it is connected to an exterior Wi-Fi network or a mobile telephone network. Large updates are downloaded only via the Wi-Fi network.

The availability of an update is notified on the screen at the end of the journey with an option of immediate installation or postponement of installation.

The installation time is variable and can take several minutes with a maximum of about 30

minutes. A notification will give an estimate of the duration and a description of the update. Update information is available through the "Settings" application.



Press the "**Settings**" application.

In the list, select the "**Updates**" tab.



This button allows you to change the authorisation for automatic downloading of updates via an exterior Wi-Fi network.



For safety reasons and because it requires sustained attention on the part of the driver, the installation must be carried out with the ignition on but without starting the engine.

The installation cannot be carried out in the following cases:

- engine running.
- emergency call in progress.
- insufficient battery level.
- when charging for electric vehicles.

If an update has failed or has expired, contact a dealer or a qualified workshop.



The Manufacturer does not charge for the use of this service.

However, the use of Wi-Fi and/or mobile telephone networks by your smartphone may incur extra charges if you exceed the data allowance included in your contract. Any associated costs will be billed to you by your mobile telephone operator.

Personalisation



Press and hold the screen from one of the system's home pages.

Or



Press the "**Settings**" application.

In the list, select the "**Customization**" tab. Press the "**Displays**" field.

A page divided into 2 parts is displayed. Press the HOME button at any time to leave this page.

Personalising the screen



Press the pencil in the "**Customize Touchscreen**" part.

A representation of the organisation of the different home page (**HOME**) Widgets is displayed.



A Widget is a reduced window of an application or service.

Adding a Widget



To add a Widget, press "**Widget**" on the left of the screen.

Or



Press one of these buttons on the screen.

Select the desired Widget.



Press the back arrow to return to the previous page.

Organising the Widgets on a home page (HOME)

To move a Widget, press and hold it, then drag it to the desired location.

Adding a page



To add a page, press "**Page**" on the left of the screen.



Press the back arrow to return to the previous page.

Deleting a Widget



To move a Widget to the bin, press and hold it, then drag it to the bin.

Personalising the instrument panel



Press the pencil in the "**Customize Driver Information**" part.

The modification of the organisation of the different Widget is displayed on the instrument panel in real time.

i A Widget is a reduced window of an application or service.

Adding a Widget



To add a Widget, press "**Widget**" on the left of the screen.

Or



Press one of these buttons on the screen.

Select the desired Widget.



Press the back arrow to return to the previous page.

Deleting a Widget



To move a Widget to the bin, press and hold it, then drag it to the bin.

Steering-mounted controls



Voice control:

Short press, system voice commands (depending on equipment).

Long press, voice commands of the smartphone connected using Bluetooth® or Mirror Screen® (Apple®CarPlay®/Android Auto) via the system.



Increase volume.



Decrease volume.

Mute the sound: long press on the decrease volume button.

Restore the sound by pressing one of the two volume buttons.



Incoming call (short press): accept the call.

Call in progress (short press): hang up.

Incoming call (long press): refuse the incoming call.

Out of call (short press): access the call log of the telephone connected via Bluetooth®.

Mirror Screen® connected (short press): access the projected view of the telephone application of your Mirror Screen® equipment.



Radio: automatic search for the previous/next station (in the list of radio stations sorted by name or by frequencies).

Media: previous/next track, movement in the lists.

Short press: validate a selection. Out of selection, display the favourite lists.



Media (short press): change the multimedia source.



Radio: display the list of favourite stations.

Media: display the list of tracks.

Applications



From the home page, press this button to access the applications wall.



From any page, press the touch screen with three or more fingers to display the applications wall.



Help

Access the handbook and watch tutorials.



Media

Select an audio source or radio station.



Mirror Screen®

Smartphone connected with Mirror

Screen®: access to the projected view of Apple®CarPlay® or Android Auto.

Smartphone not connected: access the menu allowing you to connect a smartphone.



Navigation

(depending on equipment)

Enter navigation settings and choose a destination.

Use services available in real time, depending on equipment.



Voice commands

(depending on equipment)

Use the system or smartphone voice recognition via the system.



Phone

Telephone not connected: access the menu allowing you to connect a telephone.

Telephone connected: access the call log, contacts and telephone settings.

Two connected telephones: access the contents of the priority telephone with the possibility of changing the priority of the telephone.



Settings

Main settings for the audio system, touch screen and digital instrument panel.

Brazilian, Chinese, Danish, Spanish, Hebrew, Italian, Japanese, Dutch, Norwegian, Polish, Portuguese, Russian, Swedish, Czech, Turkish) available with the cellular network and in line with the language chosen and previously configured in the system.

The system supports two languages for cases where the area in which the vehicle is travelling is not covered by the cellular network.

These languages, referred to as on-board languages, are downloaded into the system. If the chosen language has not been downloaded, a message on the screen appears as soon as the cellular network is not connected for the first time and offers to download it.

To use this new language in all areas, download it beforehand (ignition on without starting the engine) via the Wi-Fi network.

Apply the download procedure displayed on the screen.

Downloading this new language removes the least used on-board language.

Information - Using the system



When voice commands are activated, say your command after the audible signal.

For commands in several stages, interaction takes place with the system to complete the initial request.

Some commands self-validate after 7 seconds.

If the system has not taken your command into account, it will indicate this by a voice message and an on-screen display.



Press the "**Settings**" application.

In the list, select the "**Voice Assistant**" tab.



Activate/Deactivate:

– "**Listen for (OK Peugeot)**": to invoke the voice recognition using the keyword "**OK Peugeot**".

– "**Data Usage**": to authorise our supplier to re-use your data in order to let him globally improve its capabilities in term of voice recognition and voice assistance.

i Voice Assistant/Data Usage

Vehicle's location and voice recordings are not concerned; only textual transcriptions of your conversations with the voice assistant are kept after to be pseudonymised.

Opening voice recognition



Voice commands can be used on any screen page, provided there are no other sources which take priority in use (reverse, emergency or assistance call, telephone call, other smartphone voice recognition already launched).

Choice of opening voice recognition:

► Say "**OK Peugeot**".

or

Voice commands

First steps

(depending on equipment)

The voice recognition service offers a choice of 20 languages minimum (French, German, English (UK), English (US), Arabic,

- ▶ Press the button located on the steering wheel.
- or
- ▶ Press the touch screen button.

! To ensure that voice commands are always recognised by the system, please follow these recommendations:

- Use natural language in a normal tone without breaking up words or raising your voice.

- After opening voice recognition with the steering wheel-mounted button or the button on the touch screen, always wait for the "beep" (audible signal) before talking. No "beep" sounds when voice recognition is opened using "OK Peugeot".

- For optimal operation, it is recommended that you close the windows and the sunroof (depending on equipment) to avoid any external interference, and switch the ventilation off.

- Before speaking the voice commands, ask the other passengers not to speak.



Voice command example for air conditioning:

"raise the fan speed"

"Turn on air conditioning"

"i'm too hot"



Voice command example for radio and media:

"I want to listen to michael jackson"

"switch to radio"

"tune to 88.5"

i Media voice commands are only available with an USB connection.



Voice command example for navigation:

"navigate home"

"Navigate me to gabrielle's house"

"search for public parking nearby"

i Depending on the country, give destination (address) instructions in the language configured for the system.



Voice command example for telephone:

"Call Matthew's mobile"

"call 0113 345 9869"

"Call jonathan"

i If there is no telephone connected by Bluetooth®, a pop-up window appears: "Connect a telephone by Bluetooth®", and the voice session will be closed.



Voice command example for the weather:

"do i need a raincoat"

"how is the weather tonight"

"what is today's humidity level"

Navigation

Navigation home screen

(depending on equipment)

Access to additional videos



<https://www.tomtom.com/>

PSAGroup-Connected-Nav



Press the "Navigation" application to display the navigation home screen.



Press "Search" to enter an address or a name.



Press this button to display the main menu for the various options.



Press this button to display the 3D/2D mode.



Select "Sound activated", "Alerts only" and "Silent" with successive presses on this button.



Press the "plus"/"minus" buttons to zoom in/out, or use two fingers on the screen.













Main menu



Press the "Navigation" application to display the navigation home screen.



Press this button to display the main menu for the various options.

-  Select **"Search"** to enter an address, name or some points of interest.
-  Select **"Go home"** using an address previously saved in **"Add home"**.
-  Select **"Go to work"** using an address previously saved in **"My places"**.
-  Select **"Recent destinations"** to display the latest destinations searched.
-  Select **"Current trip"** to open another menu and perform various actions for the current planned route.
-  Select **"My places"** for quick access to saved places as well as favourite destinations.
-  Select **"My trips"** to display your favourite routes.
-  Select **"Parking"** to display the various parking options in the area.
-  Select **"Service station"** to display the different service stations on the current route or near the current location.
-  Select **"TomTom service"** to check the network status.
-  Select **"Settings"** to enter the vehicle type and to personalise the display, voice instructions, map options, trip planning, sounds and alerts, and system information.
-  Select this button to display details on software versions as well as legal information. Details of the Open Source software libraries used and their licence URLs.

i Regular connection to a secure Wi-Fi access point automatically updates the installed mapping globally. The mapping is also updated using a cellular network, depending on version, country of sale, the vehicle's level of equipment, as well as the subscription to connected services and options. However, using your smartphone's Wi-Fi and/or cellular networks may incur additional charges if you exceed your data plan. These charges, if any, will be passed on to your telephone operator's bill.

Connectivity

Connecting a wired device by USB

The USB connection of a mobile device allows it to be recharged. It makes its authorised media content available to the system (Media content of iPod® type).

 Only one USB socket will allow a Mirror Screen connection (Apple®CarPlay® or Android Auto) for the compatible connected mobile devices and to use some of the device's applications on the touch screen. For more information on the USB socket compatible with the Mirror Screen® function, refer to the "Ease of use and comfort - Fittings" section.

The mobile device is in charging mode when connected with the USB cable.

i It is recommended that you use your device's original USB cables, preferably with a short cable to ensure optimum performance.

! To protect the system, do not use a USB hub.

Bluetooth® connection

Connecting a mobile device to the vehicle's system via Bluetooth® provides access to its contents and its "Media" streaming. It also enables the Phone function to be activated. The connection can be initiated either from the mobile device's Bluetooth® menu or from the vehicle's system, which requires opening the "My Devices" menu for the first connection.

i In some cases, you will need to unlock your device and check the authorisation to synchronise contacts and recent calls. Some features may not be supported by your device. For information on the partial or full compatibility of device models or smartphones, please connect to the Brand's national website.

Pairing procedure from a device



From the Bluetooth® menu on your mobile device, select the system's name from the list of detected devices.



In order to make your system's Bluetooth® visible, first open the **"My Devices"** menu on the system.

Continue the first connection procedure proposed by the system and on the device. For example: validating pairing codes.

Pairing procedure from the system



Press the **"Settings"** application.

In the list, select the **"Connectivity"** tab.



Select **"My Devices"**.



Select the name of the mobile device that you want to connect, from:

- The list of known devices (if the device has already been connected to the system).
- or
- The list of detected devices (if the device has never been connected to the system or previously deleted from the system).



A mobile device already connected to the system will be able to reconnect automatically when the vehicle is started, once the user profile has been selected. Automatic reconnection is put on hold as soon as the **"My Devices"** menu is opened.

This is to allow the system to make its Bluetooth® visible for the connection of a new device.

The system is disconnected when the driver's door is opened and the ignition is switched off.

Automatic reconnection

The system allows automatic reconnection of devices already connected and detected when a user profile is selected.

The priority reconnected devices are those which have been linked to the selected user profile or, failing this, the last connected devices.

Wi-Fi connection

The system has an external Wi-Fi connection mode for performing system updates.



Press the **"Settings"** application.

In the list, select the **"Connectivity"** tab.



Select **"Wi-Fi"**.



Activate/Deactivate **"Wi-Fi"**.

The system starts a search for nearby Wi-Fi networks. This may take a few seconds.

Select the Wi-Fi network to connect to and enter its password.



To protect your system, only networks with a sufficient level of security are

allowed to connect. WPA2 encryption level, equivalent to a domestic level, is required.



Any network already connected to the system will reconnect automatically as soon as it is detected by the system and after having previously activated the Wi-Fi function.



The Wi-Fi connection of the system to a device already connected using a Mirror Screen® wireless connection is not possible. In this case, favour a Mirror Screen® connection using the USB socket.

Device management

For each device already connected to the system using a wireless connection (Bluetooth® or wireless Mirror Screen® connection), it is possible to determine a preferred connection mode (depending on the functions the device can support). It is therefore possible to determine whether the device should be connected using a wireless Bluetooth® connection or a wireless Mirror Screen® connection each time the system is started once the profile is chosen.



Press the **"Settings"** application.

In the list, select the **"Connectivity"**.



Select **"My Devices"** to display the list of paired devices.



Press this button to manage the connection of a device.

Choose a connection type then confirm this choice by pressing **"APPLY"**.

Deleting a device



Press the **"Settings"** application.

In the list, select the **"Connectivity"**.



Select **"My Devices"** to display the list of paired devices.



Press this button.

Press **"DELETE"**.

Confirm by pressing **"YES"**.



Some devices that have just been deleted from the system request a connection, refuse this request.

Mirror Screen®



When a smartphone is connected using Mirror Screen®, the vehicle's location and some vehicle data is sent to the smartphone (e.g. brand, left-hand or right-hand drive, day/night mode, physical speed).

Apple®CarPlay® smartphone connection

Connecting just one Apple®CarPlay® smartphone can be carried out either by USB cable or using a wireless connection.

i First activate the Siri® function on your Apple® smartphone.

If the device fails to connect, refer to the Apple website to check that the device is compatible with this function.

If the problem persists, delete all saved connections on the smartphone and on the system before attempting a new connection.

The cable connection requires that you deactivate the CarPlay function in the **Settings, Bluetooth** menu of your smartphone.

In the **Bluetooth** menu, click on the **"i"** next to the relevant vehicle and deactivate CarPlay.



Connect the smartphone to the system using the USB socket compatible with Mirror Screen.

Apple®CarPlay® is automatically launched a few seconds after the USB connection has been established. In some cases, it may be necessary to unlock your device.

The smartphone charges when connected by the USB cable.

The cable connection allows you to avoid disconnections, especially when passing through toll booths.

i Only one USB socket enables the Mirror Screen® connection (Apple®CarPlay®); refer to the "Ease of use and comfort - Fittings" section.

It is recommended that you use the device's original USB cables, preferably with a short cable to ensure optimum performance.

The wireless connection of an Apple®CarPlay® smartphone can be initiated from the **"My Devices"** menu.

First activate the smartphone's CarPlay® function.

In the **Bluetooth** menu, click on the **"i"** next to the relevant vehicle and activate CarPlay.



Press the **"Settings"** application.

In the list, select the **"Connectivity"**.



Select **"My Devices"** to display the device to be connected to Apple®CarPlay®.

If the device has already been connected to the system via Bluetooth®, select the device settings from the list of known devices and choose Apple®CarPlay® as the wireless connection mode.

If the device has never been connected to the system before, it will have to be paired (refer to the "Bluetooth® connection" section).

The system detects if the smartphone is compatible with Apple®CarPlay® and offers to connect to it following the pairing process. Subsequent automatic connection of the smartphone requires activation of the Bluetooth® on your device.



As soon as the connection is established, press this button to display the **"Apple®CarPlay®"** interface.



To initiate the smartphone voice commands, press and hold the steering-mounted control button.

Android Auto smartphone connection

Connecting just one Android Auto smartphone can be carried out either by USB cable or using a wireless connection.

I First install the "**Android Auto**" application via "Play Store" on your smartphone.

The "**Android Auto**" function requires a compatible smartphone.

If the device fails to connect, refer to the Android Auto website to check that the device is compatible with this function.

If the problem persists, delete all saved connections on the smartphone and on the system before attempting a new connection. To ensure an optimum wireless connection, we recommend avoiding placing your smartphone too close to other Wi-Fi networks to which it can connect automatically.

The cable connection requires that you deactivate the Android Auto wireless function, in the **Settings** menu of the "**Android Auto**" application of your smartphone.

 Connect the smartphone to the system using the USB socket compatible with Mirror Screen®.

Android Auto is automatically launched a few seconds after the USB connection has been established. A validation procedure on the

smartphone has to be followed for the first connection, with the vehicle stationary.

The smartphone charges when connected by the USB cable.

The cable connection allows you to avoid disconnections, especially when passing through toll booths.

I Only one USB socket enables the Mirror Screen® connection (Android Auto); refer to the "Ease of use and comfort - Fittings" section.

It is recommended that you use the device's original USB cables, preferably with a short cable to ensure optimum performance.

The wireless connection of an Android Auto smartphone can be initiated from the "**My Devices**" menu.

First activate the smartphone's Android Auto® wireless function, in the **Settings** menu of the "**Android Auto**" application of your smartphone.

 Press the "**Settings**" application.

In the list, select the "**Connectivity**" tab.

 Select "**My Devices**" to display the device to be connected to Android Auto.

If the device has never been connected to the system before, it will have to be paired (refer to the "Bluetooth® connection" section).

The system detects if the smartphone is compatible with Android Auto and offers to connect to it following the pairing process.

If the device has already been connected to the system via Bluetooth®, select the device settings from the list of known devices and choose Android Auto as the wireless connection mode. The subsequent automatic connection of the smartphone requires activation of Bluetooth® on your device.



As soon as the connection is established, press this button to display the "**Android Auto**" interface.



To initiate the smartphone voice commands, press and hold the steering-mounted control button.

Media

Changing source



Press the "**Media**" application.



Press this button to change source (radio, audio streaming via a USB socket, Bluetooth® or Mirror Screen®).



Using the steering-mounted controls, press this button to change source.

Selecting a radio station



Press the "**Media**" application.

In the list, select the "**Player**" tab.



Press one of the buttons to perform an automatic search for radio stations.

Or



Move the slider to manually search for frequencies up or down.

Or



Press this button.



Enter the frequency values using the virtual keypad.



Press this button to confirm.

A list of stations is available by pressing the **"Stations"** tab.



Press **"Mute"** to activate/deactivate the sound.



Radio reception may be affected by the use of electrical equipment not approved by the Brand, such as a charger with USB socket connected to the 12 V socket.

The exterior environment (hills, buildings, tunnels, basement car parks, etc.) may block reception, including in RDS mode. This phenomenon is normal in the propagation of radio waves and does not indicate any malfunction of the system.

Storing a radio station

Select a station.



Press the **"Media"** application.

In the list, select the **"Player"** tab.



Press the **"Radio Favorites"** button.



Storing takes place via a short or long press on one of these buttons, or a long press on an existing favourite radio station, which will be replaced.



Press this button to return to the previous page.

Automatic search for radio stations

Via the **"Media"** application.



Press the **"Media"** application.

In the list, select the **"Stations"** tab.

The search is carried out automatically.

Activating radio station tracking

The system changes frequency automatically to obtain better reception.



Press the **"Media"** application.

In the list, select the **"Settings"** tab.



Activate **"Radio Station Tracking"**.

The lighting of the slider confirms that the function is activated.

Changing the waveband



Press the **"Media"** application.

In the list, select the **"Player"** tab.



Press this button to change the waveband (FM - AM - DAB) according to the country of sale.

Activating traffic announcements

This function gives priority to listening to **Traffic announcements** alert messages. To be active, this function needs good reception of a radio station that transmits this type of message.

While traffic information is being broadcast, the current radio station is automatically interrupted so that the message can be heard. Normal radio listening resumes as soon as the message is finished.



Press the **"Media"** application.

In the list, select the **"Settings"** tab.



Activate **"Traffic Announcement (TA)"**.

The lighting of the slider confirms that the function is activated.

Audio streaming

The streaming function allows you to listen to the audio stream coming from the smartphone(s) connected via Bluetooth®, USB (iPod® type) or Mirror Screen®.

First adjust the volume on the portable device (to a high level).

Then adjust the volume of the system.

If playback does not start, it may be necessary to start the audio playback from the smartphone. Control is from the portable device or by using the system's touch buttons.



i Once connected in streaming mode, the smartphone is considered to be a media source.

Playing a track

 Press the "**Media**" application.

 If several devices are connected, press this button to select one.

Once the device is connected, browsing through the files is possible by pressing the "**Playlist**" or "**Library**" button.

  Short press: go to the previous/next track.

Long press: fast-forward/rewind in a track.

 Repeat the current title or the list of selected titles.

 Random track playback.

 Sound deactivation/reactivation.

Configuring audio and radio settings

Audio settings can be accessed in 2 different ways.

Via the **Media** application

 Press the "**Media**" application.

In the list, select the "**Settings**" tab.

Or

Via the **Settings** application

 Press the "**Settings**" application.

In the list, select the "**Audio and Radio**" tab.

It is possible to configure:

- Sound Settings.
- Radio Settings.
- Volume Settings.

Information and advice

The system supports USB Mass Storage devices or Apple® devices via the USB sockets. The adapter cable is not supplied.

Devices are managed using the audio system controls.

The system will only play audio files with ".wma", ".aac", ".flac", ".ogg", ".mp3" file extensions, at bit rates between 32 Kbps and 320 Kbps.

It also supports VBR (Variable Bit Rate) mode. No other file types (".mp4", etc.) can be read. ".wma" files must be of the WMA 9 standard. The supported sampling rates are 32, 44 and 48 KHz.

To avoid reading and display problems, we recommend choosing file names less than 20 characters long that do not contain any special characters (e.g. " ? . ; ù).

Use only USB memory sticks in FAT32 format (File Allocation Table).

i We recommend using the original USB cable for the portable device.

Phone

Receiving a call

An incoming call is announced by a ring and a display overlaid on the screen.

Accepting the call:

 briefly press the telephone button on the steering-mounted controls to accept an incoming call.

Or

 Press this touch screen button.

Ending the call:

 press and hold...

 ...the telephone button on the steering-mounted controls to refuse the call.

Or

 Press this touch screen button.

 Press this button on the touch screen to send an automatic message indicating that you are driving.

Making a call

! Using the telephone is strongly discouraged while driving. Park the vehicle.

Making a call using the numeric keypad



Press the **"Phone"** application.

In the list, select the **"Keypad"** tab then dial the number.



Press this button to make the call.

Making a call using the list of recent calls



Press the **"Phone"** application.

In the list, select the **"Calls"** tab.

Or

Briefly press...



...the telephone button on the steering-mounted controls.

Select and call one of the most recent numbers called in the list.

i It is always possible to make a call directly from the telephone; as a safety measure, first park the vehicle.

Calling a contact



Press the **"Phone"** application.

In the list, select the **"Contacts"** tab.

Select the desired contact in the displayed list.



Call the contact by selecting one of the contact's phone numbers.

Organising the contact list



Press the **"Phone"** application.

In the list, select the **"Settings"** tab to display the telephone-related settings.



Choose to list the contacts starting with their first or last name.

Connecting two phones

i The system allows two phones to be connected simultaneously:

- 2 via Bluetooth® connection.
- or
- 1 via Bluetooth® connection and 1 via Mirror Screen® connection.

Display and content priority is given to the last phone used.

To change the priority of the phone:



Press the **"Phone"** application.



Press this button to change the priority of the phone.

Settings

Configuring the screen display



Press the **"Settings"** application.

In the list, select the **"Customization"** tab.

It is possible to configure:

- the screen colours associated with the interior ambient lighting. Refer to the "Ease of use and comfort" section.
- the sound ambience.
- the visual welcome and goodbye animations.
- the screen transition animations.

Managing the system connectivity



Press the **"Settings"** application.

In the list, select the **"Connectivity"** tab.

It is possible to manage:

- The Bluetooth® connection.
- The Mirror Screen® smartphone connections (Apple®CarPlay®/Android Auto).
- The Wi-Fi connection.
- The privacy mode.

Configuring the system



Press the **"Settings"** application.

In the list, select the **"System"** tab.

It is possible to configure:

- the language.
- the date & time.
- the unit of distance and consumption (kWh/100 miles - miles, mi/kWh - miles, km/kWh - km).
- the temperature unit (Fahrenheit, Celsius).

It is also possible to reset the system configuration.

Selecting the language



Select "**Language**" to change the language.



Press the desired language.



Press the back arrow to return to the previous page.

Setting the date and time

Select "**Date and Time**" to modify the date and time.



"**Automatic Date and Time**" is activated by default, so that the setting is made automatically according to your geolocation.

To adjust manually, deactivate "**Automatic Date and Time**".

Press the "**Select Time Zone**" field then define a time zone.



Press the back arrow to return to the previous page.

Press the "**Time Settings**" line then set the time.



Press "**OK**" to confirm.

Press the "**Date**" line then set the date.



Press "**OK**" to confirm.



Select the Time Format (12h/24h).



Select the Date Format.

i The system does not automatically change between winter and summer time (depending on the country of sale).

Help



Press the "**Help**" application.

In the list, select the "**User Manual**" tab to consult the vehicle's handbook.

or

In the list, select the "**Tutorials**" tab to watch explanatory videos for a quick start on screen management, certain driving aids and voice recognition.

User Manual



Select the display language.

The handbook home page is displayed.

It presents the different possibilities for accessing the information sought:



Visual search

Access to subjects via pictures representing the exterior and interior of the vehicle.



Indicator lamps

Access to the descriptions/operation of the instrument panel warning/indicator lamps.



System

Access to sections dedicated to the various audio equipment and telematics systems.



Contents

Access to subjects via the main sections of the handbook.

Visual search



Press **Visual search**.

Press one of the pictures located at the bottom of the screen.



Press one of the bullet points in the enlarged view.

There are two cases:

- Direct display of the subject, if only one subject is associated with the bullet point.
- Display of a list of subjects, if several subjects are associated with the bullet point.

Indicator lamps



Press **Indicator lamps**.

The mosaic of warning/indicator lamps is displayed.

The warning/indicator lamps are sorted by colour.

Press the warning/indicator lamp concerned; the corresponding content is displayed.



Back to the mosaic of warning/indicator lamps.

System



Press **System**.

The list of audio and telematics systems is displayed.

Press on the section concerned; the list of subjects is displayed.

Press on the subject concerned; the corresponding content is displayed.



If the subject has more than one page, drag horizontally.



Back to the list of subjects.

Contents



Press **Contents**.

The list of sections is displayed.

Press on the section concerned; the list of subjects is displayed.

Press on the subject concerned; the corresponding content is displayed.



If the subject has more than one page, drag horizontally.



Back to the list of subjects.

Vehicle data recording and privacy

Electronic control units are installed in your vehicle. These control units process data received from the vehicle's sensors, for example, or data they generate themselves or exchange with each other. Some of these control units are required for the correct operation of your vehicle, some others assist you while driving (driving or manoeuvring aids), while others provide comfort or infotainment functions.

The following contains general information about how data is processed within the vehicle.

You will find additional information about the specific data which is downloaded, stored and transmitted to third parties and what it is used for in your vehicle under the keyword "Data protection". This information is directly associated with the references for the functions in question contained in the corresponding vehicle handbook, or in the general terms and conditions of sale.

This information is also available online.

Vehicle operating data

The control units process the data used for the operation of the vehicle.

This data includes, for example:

- Information about the state of the vehicle (e.g. speed, travel time, lateral acceleration, wheel rotation rate, fastened seat belts display).

- Environmental conditions (e.g. temperature, rain sensor, distance sensor).

As a general rule, this data is temporary, is not stored for longer than one operating cycle and is only used within the vehicle itself. The control units often record this data (including the vehicle's key). This function allows either the temporary or permanent storage of information about the state of the vehicle, stresses on components, servicing requirements, as well as events and technical errors.

Depending on the vehicle's equipment level, the data stored is as follows:

- Operating state of system components (e.g. filling level, tyre pressures, battery charge status).
- Faults and malfunctions in important system components (e.g. lamps, brakes).
- System reactions in specific driving situations (e.g. deployment of an airbag, triggering of stability control and braking systems).
- Information about events which have damaged the vehicle.
- For electric and rechargeable hybrid vehicles, the traction battery charge level and the estimated driving range.

In particular circumstances (e.g. if the vehicle has detected a malfunction), it may be necessary to record data which would otherwise simply not be stored.

When taking your vehicle in for servicing (e.g. repairs, maintenance), the stored operating data may be read along with the vehicle's

identification number and used if necessary.

The personnel working for the servicing network (e.g. garages, manufacturers) or third parties (e.g. roadside assistance agents) may read the vehicle's data. This also applies to work carried out under warranty and quality assurance measures.

This data is generally read via the OBD (On-Board Diagnostics) port fitted by law to the vehicle. It is used to report on the technical state of the vehicle or its components and facilitates the diagnosis of malfunctions, in compliance with warranty obligations and for quality improvement. This data, in particular the information relating to stress on components, technical events, operator errors and other malfunctions, is sent to the Manufacturer, if necessary, along with the vehicle's identification number. The Manufacturer's liability may also be engaged. The Manufacturer may also use the operating data taken from the vehicle for product recalls. This data may also be used to check the customer's warranty and any claims made under warranty.

Any malfunctions stored in the vehicle may be reset by an after-sales service company during servicing or repair work, or at your request.

Comfort and infotainment functions

Comfort settings and personalised settings may be saved in the vehicle and modified or reinitialised at any time.

Depending on the vehicle's equipment level, this may include:

- Seat and steering wheel position settings.
- Chassis and air conditioning settings.
- Personalised settings such as the interior lighting.

You can enter your own data into the functions of your vehicle's audio and telematic system, as part of the selected functionalities.

Depending on the vehicle's equipment level, this may include:

- Multimedia data such as music, videos or photos to be read by an integrated multimedia system.
- Address book data to be used with an integrated hands-free system or with an integrated navigation system.
- Entered destinations.
- Data regarding the use of online services.

This data for the comfort and infotainment functions may be stored locally in the vehicle or saved to a device that you have connected to the vehicle (e.g. smartphone, USB memory stick or MP3 player). Data that you have entered yourself may be deleted at any time.

This data may also be transmitted outside the vehicle at your request, particularly when using

online services in line with the settings that you have selected.

Smartphone integration (e.g. Android Auto® or Apple® CarPlay®)

If your vehicle is equipped accordingly, you can connect your smartphone or another mobile device to the vehicle in order to operate it using the vehicle's integrated controls. Images and sounds from the smartphone can be transmitted through the audio and telematics system.

Specific information is simultaneously sent to your smartphone. Depending on the type of integration, this includes data such as location, day/night mode and other general information about the vehicle. For more information, please refer to the user instructions for the vehicle or the audio and telematics system.

Integrating a smartphone allows you to use its applications, such as a navigation app or music player. No other integration between the smartphone and the vehicle is possible, in particular active access to vehicle data. How the data is processed subsequently is determined by the supplier of the application being used. The ability the change settings depends on the application in question and on the operating system installed on your smartphone.

Online services

If your vehicle is connected to a wireless network, data can be exchanged between your vehicle and other systems. Connection to a wireless network is made possible via a transmitter located in your vehicle or a mobile device that you have provided (e.g. smartphone). The online services can be used via this wireless connection. These include online services and applications (apps) provided to you by the Manufacturer or other suppliers.

Exclusive services

As regards the Manufacturer's online services, the corresponding functions are described by the Manufacturer in an appropriate medium (e.g. handbook, Manufacturer's website) and the information about data protection is provided. Personal data may be used for online services. The exchange of data for this purpose takes place over a secure connection, using for example the Manufacturer's dedicated computer systems. The collection, processing and use of personal data for the development of services are carried out solely on the basis of a legal authorisation, for example in the case of a legal emergency call system or a contractual agreement or else under a consent agreement. You can activate or deactivate the services and functions (some may be chargeable) and, in some cases, the vehicle's entire connection to the wireless network. This does not include the

statutory functions and services such as the emergency or assistance call system.

Third-party services

If you use online services provided by other (third-party) suppliers, these services are subject to the responsibility, the data protection and the terms and conditions of use of the supplier in question. The Manufacturer often has no influence over the content exchanged in this regard.

Please therefore ensure that you are aware of the nature, extent and purpose of the collection and use of personal data as part of the third-party services provided by the service provider in question.

3D digital instrument panel 11

A

ABS 72
 Accelerated charging unit (Wallbox) 149
 Accessories 68
 Accessories, electrical 68
 Active Safety Brake 131–133
 AdBlue® 21, 170
 AdBlue® tank 171
 Additive, Diesel 168
 Adjusting headlamps 61
 Adjusting head restraints 43
 Adjusting seat 43–44
 Adjusting the air distribution 51
 Adjusting the air flow 51
 Adjusting the date 208
 Adjusting the headlamp beam height 61
 Adjusting the height and reach
 of the steering wheel 45
 Adjusting the lumbar support 44
 Adjusting the seat angle 44
 Adjusting the temperature 50
 Adjusting the time 208, 225
 Advanced Grip Control 74
 Advice on care and maintenance 147, 173
 Advice on driving 8, 91–92
 Airbags 78, 80, 82
 Airbags, curtain 79–80
 Airbags, front 79–80, 82

Airbags, lateral 79–80
 Air conditioning 48–49, 52
 Air conditioning, automatic 52
 Air conditioning, dual-zone automatic 49
 Air intake 52
 Air vents 48
 Alarm 38–39
 Anti-lock braking system (ABS) 72–73
 Antitheft / Immobiliser 32
 Applications 27
 Assistance call 70–71
 Assistance, emergency braking 73, 133
 Audio streaming (Bluetooth) 202, 222

B

Battery, 12 V 163, 168, 185–188
 Battery, ancillaries 185–186
 Battery, charging 186–187
 Battery, remote control 36
 Blanking screen (snow shield) 162
 Blind 41–42
 Blind spot monitoring 129
 BlueHDi 21, 167, 176
 Bluetooth (hands-free) 202–203, 219
 Bluetooth (telephone) 202–203, 219–220
 Bodywork 173
 Bonnet 164–165
 Boot 38, 58
 Brake discs 169
 Brakes 169

Braking 104
 Braking assistance system 72–73
 Braking, automatic emergency 131–133
 Braking, dynamic emergency 97–98
 Brightness 207
 Bulbs (changing) 183–185

C

Capacity, fuel tank 144
 Cap, fuel filler 144
 Care of the bodywork 173
 Central locking 34
 Changing a bulb 183–185
 Changing a fuse 185
 Changing a wheel 180
 Changing a wiper blade 65–66
 Changing the remote control battery 36
 Changing to free-wheeling 172, 189
 Charge level indicator (Electric) 23
 Charger, induction 54
 Charger, wireless 54
 Charging cable 151
 Charging cable (Electric) 149
 Charging connector
 (Electric) 149, 154, 156–157
 Charging flap (Electric) 149, 154, 156–157
 Charging system (Electric) 5, 9, 146, 166
 Charging the traction battery
 (Electric) 146, 154, 156–157

- Charging the traction battery (Rechargeable hybrid) 22
- CHECK 24
- Checking the engine oil level 20
- Checking the levels 166–167
- Checking tyre pressures (using the kit) 178, 180
- Checks 165, 168–170
- Checks, routine 168–169
- Child lock 89
- Children 77, 83–84
- Children (safety) 89
- Child seats 77, 80–82, 84
- Child seats, conventional 84, 86, 88
- Child seats, i-Size 84, 86, 88
- Child seats, ISOFIX 83–84, 86, 88
- Cleaning (advice) 147, 173–174
- Closing the boot 33, 38
- Closing the doors 33–34, 37
- Collision Risk Alert 131–132
- Configuration, vehicle 11, 26–27
- Connection, Android Auto 205
- Connection, Apple CarPlay 205
- Connection, Bluetooth 202–203, 219–220
- Connectivity 224
- Consumptions 28
- Container, AdBlue® 170–171
- Control, emergency boot release 38
- Control, emergency door 35
- Control, heated seats 45
- Controls, steering mounted 101–102
- Control stalk, lighting 59–60
- Control stalk, wipers 64–67
- Control unit 149, 151
- Courtesy lamp, front 56
- Courtesy lamps 56–57
- Cruise control 115, 117–119
- Cruise control, adaptive 119
- Cruise control, adaptive with Stop function ... 115
- Cruise control by speed limit recognition 115
-
- D**
- DAB (Digital Audio Broadcasting) - Digital radio 201
- Date (setting) 208, 225
- Daytime running lamps 60, 184
- Deactivating the passenger airbag 79, 82
- Deadlocking 31, 33
- Deferred charging 28
- Deferred charging (Electric) 28, 149, 154, 157
- Deferred charging (Rechargeable hybrid) 28
- Defrosting 46, 52
- Defrosting, front 52
- Defrosting, rear screen 52
- Demisting 46, 52
- Demisting, front 52
- Demisting, rear 52
- Diagnosis, vehicle 24
- Dials and gauges 10–11
- Dimensions 196
- Dipstick 20, 166
- Direction indicators (turn signals) 60, 184
- Display screen, instrument panel 10–11
- Domestic charging 151
- Domestic charging (Electric) 156–157, 195
- Doors 37
- Drive Assist Plus 119
- Drive, electric 5, 9, 28, 146, 159, 166, 186, 189, 195
- Driver's attention warning 135
- Drive selector (Electric) 103
- Driving 91–92
- Driving aids camera (warnings) 110
- Driving aid shortcuts 111
- Driving aids (recommendations) 110
- Driving economically 8
- Driving modes 75, 104
- Driving modes (Electric) 105
- Dynamic stability control (DSC) 73
-
- E**
- EBFD 72
- Eco-driving (advice) 8
- ECO mode 104–105
- Electric windows 40
- Electronic brake force distribution (EBFD) 72–73
- Emergency braking assistance (EBA) 73
- Emergency call 70–71
- Emergency switching off 95–96
- Emergency warning lamps 69, 176
- Emissions control system, SCR 22, 170

Energy economy (mode) 163
 Energy economy mode 163
 Energy flows 28
 Energy recovery 22, 104
 Engine 170
 Engine compartment 165
 Engine, Diesel 144, 165, 176, 194
 Engine, petrol 165, 193
 Engines 192–194
 Environment 8, 36, 92
 ESC (electronic stability control) 72
 Event data recorder 68
 Expanded traffic sign recognition 115
 Exterior lighting 62

F

Fatigue detection 134–135
 Favourite driving functions 111
 Filling the AdBlue® tank 167, 171
 Filling the fuel tank 144–145
 Filter, air 168
 Filter, oil 168
 Filter, particle 168
 Filter, passenger compartment 48, 168
 Fitting a wheel 181–182
 Fitting roof bars 161–162
 Fittings, boot 57
 Fittings, interior 53–54
 Flap, fuel filler 144–145
 Flashing indicators 60, 184

Floor, boot, adjustable 57
 Fluid, brake 167
 Fluid, engine coolant 167
 Foglamp, rear 59
 Foglamps, rear 185
 Folding the rear seats 47–48
 Frequency (radio) 222
 Fuel 8, 144
 Fuel consumption 8, 22
 Fuel level, low 144
 Fuel (tank) 144–145
 Fuses 185

G

Gauge, fuel 144
 Gearbox, automatic 99, 101–103, 169, 186
 Gearbox, manual 99, 169
 Gear lever 106
 Gear lever, manual gearbox 99
 Gear shift indicator 106
 Glove box 54

H

Hazard warning lamps 69, 176
 Headlamps (adjustment) 61
 Headlamps, automatic dipping 63–64
 Headlamps, automatic operation 61
 Headlamps, dipped beam 184

Headlamps, main beam 63, 184
 Head restraints, front 43
 Head restraints, rear 47–48
 Heating 48
 Heating, programmable 28, 53
 High voltage 146
 Hill Assist Descent Control (HADC) 75
 Hill start assist 105–106
 Histogramme, fuel consumption 28
 Horn 69

I
 Ignition 95, 224
 Ignition on 95
 Immobiliser, electronic 93
 Indicator, AdBlue® range 21
 Indicator, coolant temperature 21
 Indicator, engine oil level 20
 Indicators, direction 60, 184
 Indicator, service 19
 Inflating tyres 169, 196
 Inflating tyres and accessories
 (using the kit) 178, 180
 Information, vehicle 227
 Infrared camera 110
 Instrument panel 10–11, 25, 111
 Instrument panel, matrix 10
 ISOFIX mountings 83, 86, 88

J
 Jack 177–178, 180
 Jump starting 187

K
 Key 30, 32, 35
 Key, electronic 33–34
 Keyless Entry and Starting 32–33, 94–95
 Key not recognised 95–96
 Key with remote control 30, 93
 Kit, hands-free 202–203, 219
 Kit, puncture repair 177
 Kit, temporary puncture repair 176–178, 180
 Klaxon 69

L
 Labels, identification 196
 Lamps, parking 60
 Lamps, rear 185
 Lamps with Full LED technology 61
 Lane keeping assist 127
 Lane positioning assist 119, 123–125
 Leather (care) 174
 LEDs - Light-emitting diodes 60, 184
 Level, AdBlue® 167
 Level, brake fluid 167
 Level, Diesel additive 168

Level, engine coolant 21, 167
 Level, engine oil 20, 166
 Levels and checks 165–167
 Level, screenwash fluid 65, 167
 Light-emitting diodes - LEDs 60, 184
 Lighting, boot 58
 Lighting dimmer 24–25
 Lighting, exterior 59, 62
 Lighting, guide-me home 31, 62
 Lighting, interior 56–57
 Lighting, mood 57
 Lighting, welcome 62
 Loading 161
 Load reduction mode 164
 Locating your vehicle 31
 Locking 31–33
 Locking from the inside 34
 Locking the doors 34–35
 Log, alerts 24
 Lumbar 44

M
 Mains socket (domestic network) 149
 Maintenance (advice) 147, 173
 Maintenance, routine 111, 168–170
 Manoeuvring aids (recommendations) 110
 Map reading lamps 56
 Markings, identification 196
 Massage function 44
 Mat 55, 111

Menu, main 27
 Menus (audio) 198–199
 Menu, shortcuts 27
 Minimum traction battery charge level
 (Electric) 23
 Mirror, rear view 46
 Mirrors, door 45, 52, 129
 Mirror, vanity 54
 Misfuel prevention 145
 Mobile application 28, 53, 157
 Motor, electric 95, 166, 195
 Mountings, ISOFIX 83, 86, 88

N
 Normal mode 105

O
 Obstacle detection 136
 Oil change 166
 Oil consumption 166
 Oil, engine 166
 On-board tools 58, 176–177
 Opening the bonnet 164–165
 Opening the boot 33, 38
 Opening the doors 33, 37

P

Pads, brake 169

Paint 173, 196

Paint colour code 196

Parking brake 96, 169

Parking brake, electric 96–98, 169

Parking (sensors) 136

Parking sensors, audible and visual 136

Parking sensors, front 137

Parking sensors, rear 136

Parking sensors, side 137

Passenger compartment temperature
pre-conditioning (Electric) 28, 53

Pedestrian horn (Electric) 69, 92

Personalisation 11

Plates, identification 196

Player, Apple® 202

Player, USB 201

Port, USB 54, 201, 204

Power 22

Power indicator (Electric) 9

Power indicator (Rechargeable hybrid) 22

Pressures, tyres 169, 178, 180, 196

Pre-tensioning (seat belts) 77

Priming the fuel system 176

Profiles 212

Protecting children 79–84

Proximity Keyless Entry and Start 32

Public fast charging station 149, 156

Puncture 178, 180

R

Radar (warnings) 110

Radio 199–200, 221–222

Radio,
digital (Digital Audio Broadcasting - DAB) 201

Range, AdBlue® 21, 167

RDS 200

Reading lamps 56

Reading lamps, touch-sensitive 56–57

Rear bench seat 47

Rear screen (demisting) 52

Rechargeable hybrid engine 28

Rechargeable hybrid system 28

Recharging the battery 186–187

Recharging the traction battery 151

Recharging the traction battery
(Electric) 146, 154, 156–157

Recirculation, air 52

Recorder, trip distance 24

Reduction of electrical load (mode) 164

Regeneration of the particle filter 168

Regenerative braking (deceleration by engine
braking) 103–104

Reinitialising the remote control 37

Reinitialising the under-inflation
detection system 109

Reminder, key in ignition 94

Reminder, lighting on 59

Remote control 30–35

Remotely operable functions
(Electric) 28, 53, 157

Removing a wheel 181–182

Removing the mat 55

Replacing bulbs 183–185

Replacing fuses 185

Replacing the air filter 168

Replacing the oil filter 168

Replacing the passenger
compartment filter 168

Reservoir, screenwash 167

Resetting the trip 25

Reversing camera 110, 138–140

Road sign recognition 112

Roof bars 161–162

Roof, opening 41–42

Running out of fuel (Diesel) 176

S

Safety, children 79–84

Saturation of the particle filter (Diesel) 168

Screens, very cold conditions 162

Screenwash 65

Screenwash, front 65

Screenwash, rear 65

SCR (Selective Catalytic Reduction) 22, 170

Seat angle 44

Seat belts 76–77

Seat belts, rear 77

Seats, electric 44

Seats, front 43–44

Seats, heated 45

Ventilation 48
Visibility 52
Visiopark 1 138
Visiopark 1 - Visiopark 2 138, 140

W

Wallbox (Electric) 149
Warning and indicator lamps 12
Warning lamp, driver's seat belt
not fastened 77
Warning lamps 12
Warning lamp, seat belts 77
Warnings and indicators 12
Washing 111
Washing (advice) 147, 173
Weights 192–194
Welcome lighting 31, 62
Wheel, spare 169, 176–177, 180–181
Wiper blades (changing) 65–66
Wiper, rear 65
Wipers 64, 67
Wipers, automatic rain sensitive 66–67
Wipers, windscreen 64, 66

Recycled materials/End-of-Life Vehicles

Automobiles PEUGEOT declares, in accordance with the provisions of European legislation (Directive 2000/53) and The End-of-Life Vehicles (Producer Responsibility) (Amendment) Regulation 2010 No.1094, that it achieves the objectives set by these legislations and that recycled materials are used in the manufacture of the products that it sells.

Reproducing and translating this document, even partially, is strictly prohibited without written authorisation from Automobiles PEUGEOT.



4D CONCEPT

AUTOMOBILES PEUGEOT - Siège Social : 2-10, boulevard de l'Europe - 78300 POISSY
<http://www.peugeot.com>
Société anonyme au capital de 172.711.770 € - R.C.S. VERSAILLES : 552 144 503

Printed in the EU
06-23



PEUGEOT



ANG. 23P24.0040

